

# Simulink® Coder™

## User's Guide

**R2012b**

**MATLAB®  
& SIMULINK®**

## How to Contact MathWorks



[www.mathworks.com](http://www.mathworks.com)  
[comp.soft-sys.matlab](mailto:comp.soft-sys.matlab@mathworks.com)  
[www.mathworks.com/contact\\_TS.html](http://www.mathworks.com/contact_TS.html)

Web  
Newsgroup  
Technical Support



[suggest@mathworks.com](mailto:suggest@mathworks.com)  
[bugs@mathworks.com](mailto:bugs@mathworks.com)  
[doc@mathworks.com](mailto:doc@mathworks.com)  
[service@mathworks.com](mailto:service@mathworks.com)  
[info@mathworks.com](mailto:info@mathworks.com)

Product enhancement suggestions  
Bug reports  
Documentation error reports  
Order status, license renewals, passcodes  
Sales, pricing, and general information



508-647-7000 (Phone)



508-647-7001 (Fax)



The MathWorks, Inc.  
3 Apple Hill Drive  
Natick, MA 01760-2098

For contact information about worldwide offices, see the MathWorks Web site.

*Simulink® Coder™ User's Guide*

© COPYRIGHT 2011–2012 by The MathWorks, Inc.

The software described in this document is furnished under a license agreement. The software may be used or copied only under the terms of the license agreement. No part of this manual may be photocopied or reproduced in any form without prior written consent from The MathWorks, Inc.

FEDERAL ACQUISITION: This provision applies to all acquisitions of the Program and Documentation by, for, or through the federal government of the United States. By accepting delivery of the Program or Documentation, the government hereby agrees that this software or documentation qualifies as commercial computer software or commercial computer software documentation as such terms are used or defined in FAR 12.212, DFARS Part 227.72, and DFARS 252.227-7014. Accordingly, the terms and conditions of this Agreement and only those rights specified in this Agreement, shall pertain to and govern the use, modification, reproduction, release, performance, display, and disclosure of the Program and Documentation by the federal government (or other entity acquiring for or through the federal government) and shall supersede any conflicting contractual terms or conditions. If this License fails to meet the government's needs or is inconsistent in any respect with federal procurement law, the government agrees to return the Program and Documentation, unused, to The MathWorks, Inc.

### Trademarks

MATLAB and Simulink are registered trademarks of The MathWorks, Inc. See [www.mathworks.com/trademarks](http://www.mathworks.com/trademarks) for a list of additional trademarks. Other product or brand names may be trademarks or registered trademarks of their respective holders.

### Patents

MathWorks products are protected by one or more U.S. patents. Please see [www.mathworks.com/patents](http://www.mathworks.com/patents) for more information.

### Revision History

April 2011	Online only	New for Version 8.0 (Release 2011a)
September 2011	Online only	Revised for Version 8.1 (Release 2011b)
March 2012	Online only	Revised for Version 8.2 (Release 2012a)
September 2012	Online only	Revised for Version 8.3 (Release 2012b)

## **Check Bug Reports for Issues and Fixes**

Software is inherently complex and is not free of errors. The output of a code generator might contain bugs, some of which are not detected by a compiler. MathWorks reports critical known bugs brought to its attention on its Bug Report system at [www.mathworks.com/support/bugreports/](http://www.mathworks.com/support/bugreports/). Use the Saved Searches and Watched Bugs tool with the search phrase “Incorrect Code Generation” to obtain a report of known bugs that produce code that might compile and execute, but still produce wrong answers.

The bug reports are an integral part of the documentation for each release. Examine periodically all bug reports for a release, as such reports may identify inconsistencies between the actual behavior of a release you are using and the behavior described in this documentation.

In addition to reviewing bug reports, you should implement a verification and validation strategy to identify potential bugs in your design, code, and tools.



## Model Architecture and Design

### Modeling

**1**

<b>Configure a Model for Code Generation</b> .....	<b>1-2</b>
<b>Scheduling</b> .....	<b>1-4</b>
About Scheduling .....	1-4
Single-Tasking and Multitasking Execution Modes .....	1-5
Handle Rate Transitions .....	1-13
Single-Tasking and Multitasking Model Execution .....	1-27
Handle Asynchronous Events .....	1-34
Timers .....	1-79
Configure Scheduling .....	1-90
<b>Supported Products and Block Usage</b> .....	<b>1-92</b>
Related Products .....	1-92
Simulink Built-In Blocks That Support Code Generation ..	1-94
Block Set Support for Code Generation .....	1-116
Fixed-Point Tool Data Type Override .....	1-116
Data Type Overrides Unavailable for Most Blocks in Embedded Targets and Desktop Targets .....	1-116
<b>Modeling Semantic Considerations</b> .....	<b>1-117</b>
Data Propagation .....	1-117
Sample Time Propagation .....	1-119
Latches for Subsystem Blocks .....	1-120
Block Execution Order .....	1-120
Algebraic Loops .....	1-122

<b>Code Generation of Subsystems</b> .....	2-2
Subsystem Code Dependence .....	2-3
<b>Generate Code and Executables for Individual Subsystem</b> .....	2-4
Subsystem Build Limitations .....	2-6
<b>Inline Subsystem Code</b> .....	2-7
Configure Subsystem to Inline Code .....	2-7
Exceptions to Inlining .....	2-8
<b>Generate Subsystem Code as Separate Function and Files</b> .....	2-10
<b>Generate Reusable Function for Identical Subsystems Within a Model</b> .....	2-11
Considerations for <b>Function Packaging</b> Options Auto and Reusable function .....	2-13
<b>Optimize Code for Identical Nested Subsystems</b> .....	2-14
<b>Generate Reusable Code for Subsystems Containing S-Function Blocks</b> .....	2-15
<b>Generate Reusable Code from Stateflow Charts</b> .....	2-16
<b>Code Reuse Limitations for Subsystems</b> .....	2-17
Blocks That Prevent Code Reuse .....	2-17
Code Reuse Limitations for Subsystems Shared Across Referenced Models .....	2-18
<b>Code Reuse For Subsystems Shared Across Referenced Models</b> .....	2-19
<b>Reusable Library Subsystem</b> .....	2-20

Code Generation of a Reusable Library Subsystem .....	2-20
Reusable Library Subsystem Code Placement and Naming .....	2-21
Reusable Library Subsystem in the Top Model .....	2-21
Reusable Library Subsystem Connected to Root Output ..	2-21
 <b>Code Generation of Constant Parameters .....</b>	<b>2-22</b>
 <b>Shared Constant Parameters for Code Reuse .....</b>	<b>2-23</b>
Shared Constant Parameters Limitations .....	2-24
 <b>Generate Reusable Code for Subsystems Shared Across Models .....</b>	<b>2-25</b>
 <b>Determine Why Subsystem Code Is Not Reused .....</b>	<b>2-32</b>
Review the Subsystems Section of the HTML Code Generation Report .....	2-32
Compare Subsystem Checksum Data .....	2-32

## Referenced Models

# 3

<b>Code Generation for Referenced Models .....</b>	<b>3-2</b>
 <b>Generate Code for Referenced Models .....</b>	<b>3-4</b>
About Generating Code for Referenced Models .....	3-4
Create and Configure the Subsystem .....	3-4
Convert Model to Use Model Referencing .....	3-7
Generate Model Reference Code for a GRT Target .....	3-11
Work with Project Folders .....	3-14
 <b>Project Folder Structure for Model Reference Targets .....</b>	<b>3-16</b>
 <b>Configure Referenced Models .....</b>	<b>3-17</b>
 <b>Build Model Reference Targets .....</b>	<b>3-18</b>

Reduce Change Checking Time .....	3-18
<b>Simulink Coder Model Referencing Requirements ....</b>	<b>3-19</b>
Configuration Parameter Requirements .....	3-19
Naming Requirements .....	3-23
Custom Target Requirements .....	3-24
<b>Storage Classes for Signals Used with Model Blocks ..</b>	<b>3-25</b>
Storage Classes for Parameters Used with Model Blocks ..	3-26
Effects of Signal Name Mismatches .....	3-27
<b>Inherited Sample Time for Referenced Models .....</b>	<b>3-29</b>
<b>Customize Library File Suffix and File Type .....</b>	<b>3-31</b>
<b>Reusable Code and Referenced Models .....</b>	<b>3-32</b>
General Considerations .....	3-32
Code Reuse and Model Blocks with Root Inport or Outport Blocks .....	3-33
<b>Simulink Coder Model Referencing Limitations .....</b>	<b>3-36</b>
Customization Limitations .....	3-36
Data Logging Limitations .....	3-36
State Initialization Limitation .....	3-37
Reusability Limitations .....	3-38
S-Function Limitations .....	3-39
Simulink Tool Limitations .....	3-39
Subsystem Limitations .....	3-39
Target Limitations .....	3-39
Other Limitations .....	3-40

## Combined Models

# 4

<b>Combined Models .....</b>	<b>4-2</b>
<b>Use GRT Malloc to Combine Models .....</b>	<b>4-4</b>



Share Data Across Models .....	4-4
Timing Issues .....	4-4
Data Logging and External Mode Support .....	4-5

## Configure Model Parameters

# 5

<b>Platform Options for Development and Deployment ..</b>	<b>5-2</b>
<b>Configure Emulation and Embedded Target</b>	
<b>Hardware .....</b>	<b>5-3</b>
Identify the Device Vendor .....	5-4
Identify the Device Type .....	5-5
Register Additional Device Vendor and Device Type Values .....	5-5
Set Native Word Size for the Device .....	5-9
Set Byte Ordering Used By Device .....	5-10
Set Quotient Rounding Technique for Signed Integer Division .....	5-11
Set Arithmetic Right Shift Behavior for Signed Integers ..	5-12
 <b>Configure Embedded Hardware Characteristics .....</b>	 <b>5-13</b>
 <b>Configure Emulation Hardware Characteristics .....</b>	 <b>5-15</b>
Update Release 14 Hardware Configuration .....	5-17
 <b>Control the Location for Generated Files .....</b>	 <b>5-18</b>
 <b>Control Generated Files Location Used for     Simulation .....</b>	 <b>5-20</b>
 <b>Control the Location for Code Generation Files .....</b>	 <b>5-22</b>
 <b>Override Build Folder Settings for Current Session ...</b>	 <b>5-24</b>

## Model Protection

# 6

<b>Protect a Referenced Model</b> .....	6-2
Requirements for Protecting a Model .....	6-3
<b>Harness Model</b> .....	6-4
<b>Protected Model Report</b> .....	6-5
<b>Code Generation Support in a Protected Model</b> .....	6-6
Protected Model Requirements to Support Code Generation .....	6-6
<b>Protected Model File</b> .....	6-8
<b>Create a Protected Model</b> .....	6-9
<b>Test the Protected Model</b> .....	6-13
<b>Save Base Workspace Definitions</b> .....	6-15
<b>Package a Protected Model</b> .....	6-16

## Data, Function, and File Definition

### Data Representation

# 7

<b>Enumerations</b> .....	7-2
About Enumerated Data Types .....	7-2
Default Code for an Enumerated Data Type .....	7-2
Type Casting for Enumerations .....	7-3
Override Default Methods (Optional) .....	7-4
Enumerated Type Limitations .....	7-7

<b>Structure Parameters and Generated Code</b> .....	<b>7-8</b>
About Structure Parameters and Generated Code .....	7-8
Configure Structure Parameters for Generated Code .....	7-8
Control Name of Structure Parameter Type .....	7-9
<b>Parameters</b> .....	<b>7-10</b>
About Parameters .....	7-10
Nontunable Parameter Storage .....	7-11
Tunable Parameter Storage .....	7-13
Tunable Parameter Storage Classes .....	7-14
Declare Tunable Parameters .....	7-17
Tunable Expressions .....	7-22
Linear Block Parameter Tunability .....	7-26
Configuration Parameter Quick Reference Diagram .....	7-27
Generated Code for Parameter Data Types .....	7-28
Tunable Workspace Parameter Data Type Considerations .....	7-34
Tune Parameters .....	7-36
Parameter Objects .....	7-38
Structure Parameters and Generated Code .....	7-49
<b>Signals</b> .....	<b>7-52</b>
About Signals .....	7-52
Signal Storage Concepts .....	7-53
Signals with Auto Storage Class .....	7-55
Signals with Test Points .....	7-59
Interface Signals to External Code .....	7-60
Symbolic Naming Conventions for Signals .....	7-62
Summary of Signal Storage Class Options .....	7-63
Interfaces for Monitoring Signals .....	7-64
Signal Objects .....	7-65
Initialize Signals and States Using Signal Objects .....	7-74
<b>States</b> .....	<b>7-83</b>
About States .....	7-83
State Storage .....	7-83
State Storage Classes .....	7-84
Interface States to External Code .....	7-85
Symbolic Names for States .....	7-87
Control Code Generation for Block States .....	7-90
Summary of State Storage Class Options .....	7-91

<b>Data Stores</b> .....	<b>7-93</b>
About Data Stores .....	<b>7-93</b>
Storage Classes for Data Store Memory Blocks .....	<b>7-93</b>
Generate Code for Data Store Memory Blocks .....	<b>7-96</b>
Nonscalar Data Stores in Generated Code .....	<b>7-97</b>
Data Store Buffering in Generated Code .....	<b>7-99</b>

## Entry Point Functions and Scheduling

# 8

<b>Entry Point Functions and Scheduling</b> .....	<b>8-2</b>
<b>About Model Execution</b> .....	<b>8-4</b>
<b>Non-Real-Time Single-Tasking Systems</b> .....	<b>8-6</b>
<b>Non-Real-Time Multitasking Systems</b> .....	<b>8-7</b>
<b>Real-Time Single-Tasking Systems</b> .....	<b>8-9</b>
<b>Real-Time Multitasking Systems</b> .....	<b>8-11</b>
<b>Multitasking Systems Using Real-Time Tasking</b>	
<b>Primitives</b> .....	<b>8-14</b>
<b>Program Timing</b> .....	<b>8-16</b>
<b>Program Execution</b> .....	<b>8-18</b>
<b>External Mode Communication</b> .....	<b>8-19</b>
<b>Data Logging in Single-Tasking and Multitasking</b>	
<b>Model Execution</b> .....	<b>8-20</b>

<b>Rapid Prototyping and Embedded Model Execution Differences</b> .....	8-22
<b>Rapid Prototyping Model Functions</b> .....	8-23
<b>Embedded Model Functions</b> .....	8-30

# Code Generation

## Configuration

### 9

<b>Configuring a Model for Code Generation</b> .....	9-2
Code Generation Configuration .....	9-2
Open the Model Configuration for Code Generation .....	9-3
Configure a Model Programmatically .....	9-3
<b>Application Objectives</b> .....	9-6
About Code Generation Objectives .....	9-6
Configure Code Generation Objectives Using Code Generation Advisor .....	9-7
<b>Target</b> .....	9-9
Hardware Targets .....	9-9
Available Targets .....	9-10
About Targets and Code Formats .....	9-15
Types of Target Code Formats .....	9-16
Targets and Code Formats .....	9-29
Targets and Code Styles .....	9-29
Backwards Compatibility of Code Formats .....	9-31
Selecting a Target .....	9-34
Template Makefiles and Make Options .....	9-38
Custom Targets .....	9-44
Describing the Emulation and Embedded Targets .....	9-45
Describing Embedded Hardware Characteristics .....	9-54
Describing Emulation Hardware Characteristics .....	9-55
Specifying Target Interfaces .....	9-58
Selecting and Viewing Code Replacement Libraries .....	9-61

<b>Select the Target Language</b> .....	<b>9-71</b>
<b>Code Appearance</b> .....	<b>9-72</b>
Configure Code Comments .....	<b>9-72</b>
Configure Generated Identifiers .....	<b>9-73</b>
<b>Debug</b> .....	<b>9-80</b>

## Source Code Generation

# 10

<b>Initiate Code Generation</b> .....	<b>10-2</b>
<b>Reload Generated Code</b> .....	<b>10-3</b>
<b>Generated Source Files and File Dependencies</b> .....	<b>10-4</b>
About Generated Files and File Dependencies .....	<b>10-4</b>
Header Dependencies When Interfacing Legacy/Custom Code with Generated Code .....	<b>10-6</b>
Dependencies of the Generated Code .....	<b>10-16</b>
Specify Include Paths in Simulink Coder Generated Source Files .....	<b>10-21</b>
<b>Files and Folders Created by Build Process</b> .....	<b>10-24</b>
Files Created During the Build Process .....	<b>10-24</b>
Folders Used During the Build Process .....	<b>10-28</b>
<b>How Code Is Generated From a Model</b> .....	<b>10-31</b>
Model Compilation .....	<b>10-31</b>
Code Generation .....	<b>10-31</b>
<b>Code Generation of Matrices and Arrays</b> .....	<b>10-33</b>
Simulink Coder Matrix Parameters .....	<b>10-34</b>
Internal Data Storage for Complex Number Arrays .....	<b>10-36</b>
<b>Shared Utility Code</b> .....	<b>10-37</b>
About Shared Utility Code .....	<b>10-37</b>

Controlling Shared Utility Code Placement .....	10-38
rtwtypes.h and Shared Utility Code .....	10-38
Incremental Shared Utility Code Generation and Compilation .....	10-39
Shared Utility Checksum .....	10-39
Shared Fixed-Point Utility Functions .....	10-41
Share User-Defined Data Types Across Models .....	10-43

<b>Generating Code Using Simulink Coder™ .....</b>	<b>10-49</b>
--	--------------

## Report Generation

# 11

<b>Reports for Code Generation .....</b>	<b>11-2</b>
<b>HTML Code Generation Report Location .....</b>	<b>11-3</b>
<b>HTML Code Generation Report for Referenced   Models .....</b>	<b>11-4</b>
<b>Generate a Code Generation Report .....</b>	<b>11-5</b>
<b>Generate Code Generation Report After Build   Process .....</b>	<b>11-6</b>
<b>Open Code Generation Report .....</b>	<b>11-8</b>
Limitation .....	11-8
<b>Generate Code Generation Report   Programmatically .....</b>	<b>11-10</b>
<b>Search in the Code Generation Report .....</b>	<b>11-11</b>
<b>View Code Generation Report in Model Explorer .....</b>	<b>11-12</b>
<b>Package and Share the Code Generation Report .....</b>	<b>11-14</b>

Package the Code Generation Report .....	11-14
View the Code Generation Report .....	11-15

### **Document Generated Code with Simulink Report**

<b>Generator</b> .....	11-16
Generate Code for the Model .....	11-17
Open the Report Generator .....	11-18
Set Report Name, Location, and Format .....	11-20
Include Models and Subsystems in a Report .....	11-21
Customize the Report .....	11-22
Generate the Report .....	11-23

# Deployment

## Desktops

# 12

<b>Rapid Simulations</b> .....	12-2
About Rapid Simulation .....	12-2
Rapid Simulation Performance .....	12-3
General Rapid Simulation Workflow .....	12-3
Identify Rapid Simulation Requirements .....	12-4
Configure Inports to Provide Simulation Source Data ....	12-6
Configure and Build Model for Rapid Simulation .....	12-6
Set Up Rapid Simulation Input Data .....	12-9
Scripts for Batch and Monte Carlo Simulations .....	12-19
Run Rapid Simulations .....	12-20
Rapid Simulation Target Limitations .....	12-33
<b>Generated S-Function Block</b> .....	12-34
About Object Libraries .....	12-34
Create S-Function Blocks from a Subsystem .....	12-37
Tunable Parameters in Generated S-Functions .....	12-42
System Target File and Template Makefiles .....	12-44
Checksums and the S-Function Target .....	12-45
S-Function Target Limitations .....	12-45



**13**

<b>Real-Time System Rapid Prototyping</b> .....	13-2
About Real-Time Rapid Prototyping .....	13-2
Goals of Real-Time Rapid Prototyping .....	13-3
Refine Code With Real-Time Rapid Prototyping .....	13-3
<b>Hardware-In-the-Loop (HIL) Simulation</b> .....	13-5
About Hardware-In-the-Loop Simulation .....	13-5
Set Up and Run HIL Simulations .....	13-6

**External Code Integration**

**14**

<b>Integration Options</b> .....	14-2
About Integration Options .....	14-2
Types of External Code Integration .....	14-2
<b>Reuse Algorithmic Components in Generated Code</b> ...	14-5
Reusable Algorithmic Components .....	14-5
Integrate External MATLAB Code .....	14-5
Integrate External C or C++ Code .....	14-8
Integrate Fortran Code .....	14-11
Integration Considerations for Reusable Algorithmic Components .....	14-11
<b>Deploy Algorithm Code Within a Target     Environment</b> .....	14-14
<b>Export Generated Algorithm Code for Embedded     Applications</b> .....	14-18
<b>Export Algorithm Executables for System     Simulation</b> .....	14-21
<b>Modify External Code for Language Compatibility</b> ...	14-22

<b>Automate S-Function Generation</b> .....	<b>14-23</b>
<b>Integrate External Code Using Legacy Code Tool</b> .....	<b>14-28</b>
Legacy Code Tool and Code Generation .....	14-28
Generate Inlined S-Function Files for Code Generation ..	14-29
Apply Code Style Settings to Legacy Functions .....	14-30
Address Dependencies on Files in Different Locations ....	14-31
Deploy S-Functions for Simulation and Code Generation ..	14-32
<b>Configure Model for External Code Integration</b> .....	<b>14-33</b>
<b>Insert Custom Code Blocks</b> .....	<b>14-36</b>
Custom Code Library .....	14-36
Embed Custom Code Directly Into MdlStart Function ....	14-40
Custom Code in Subsystems .....	14-43
Preserve User Files in Build Folder .....	14-44
<b>Insert S-Function Code</b> .....	<b>14-46</b>
About S-Functions and Code Generation .....	14-46
Write Noninlined S-Functions .....	14-52
Write Wrapper S-Functions .....	14-54
Write Fully Inlined S-Functions .....	14-64
Write Fully Inlined S-Functions with mdlRTW Routine ..	14-65
Guidelines for Writing Inlined S-Functions .....	14-91
Write S-Functions That Support Expression Folding .....	14-91
S-Functions That Specify Port Scope and Reusability ....	14-105
S-Functions That Specify Sample Time Inheritance	
Rules .....	14-111
S-Functions That Support Code Reuse .....	14-113
S-Functions for Multirate Multitasking Environments ...	14-113
Build Support for S-Functions .....	14-120

## Program Building, Interaction, and Debugging

# 15

<b>Compiler or IDE Selection and Configuration</b> .....	<b>15-2</b>
Choose and Configure a Compiler .....	15-2
Troubleshoot Compiler Configurations .....	15-9

<b>Program Builds</b> .....	<b>15-12</b>
Configure the Build Process .....	15-12
Initiate the Build Process .....	15-14
Build a Generic Real-Time Program .....	15-14
Rebuild a Model .....	15-27
Control Regeneration of Top Model Code .....	15-27
Reduce Build Time for Referenced Models .....	15-28
Relocate Code to Another Development Environment .....	15-33
How Executable Programs Are Built From Models .....	15-38
<b>Build and Run a Program</b> .....	<b>15-43</b>
<b>Profile Code Performance</b> .....	<b>15-45</b>
About Profiling Code Performance .....	15-45
How to Profile Code Performance .....	15-45
Run Profiling Hooks for Generated Code .....	15-48
Profiling Limitation .....	15-49
<b>Data Exchange</b> .....	<b>15-50</b>
Host/Target Communication .....	15-50
Logging .....	15-105
Parameter Tuning .....	15-119
Data Interchange Using the C API .....	15-137
ASAP2 Data Measurement and Calibration .....	15-174
Direct Memory Access to Generated Code .....	15-189

# Performance

## Optimizations for Generated Code

### 16

<b>Optimization Parameters</b> .....	<b>16-2</b>
<b>Advice About Optimizing Models for Code     Generation</b> .....	<b>16-5</b>
<b>Control Compiler Optimizations</b> .....	<b>16-6</b>

<b>Optimization Tools and Techniques</b> .....	16-7
<b>Control Memory Allocation for Time Counters</b> .....	16-9
<b>Optimization Dependencies</b> .....	16-10

## Defensive Programming

# 17

<b>Optimize Code for Floating-Point to Integer</b>	
<b>Conversions</b> .....	17-2
Remove Code That Wraps Out-of-Range Values .....	17-2
Remove Code That Maps NaN to Integer Zero .....	17-3
<b>Disable Nonfinite Checks or Inlining for Math</b>	
<b>Functions</b> .....	17-4

## Data Copy Reduction

# 18

<b>Optimizing Generated Code</b> .....	18-2
About Optimizing Generated Code .....	18-2
Setting Up the Model .....	18-2
<b>Generate Code Without Buffer Optimization</b> .....	18-4
<b>Generate Code With Buffer Optimization</b> .....	18-9
<b>Minimize Computations and Storage for Intermediate</b>	
<b>Results</b> .....	18-11
About Expression Folding .....	18-11
Expression Folding Example .....	18-12
Enable Expression Folding .....	18-15

<b>Declare Signals as Local Function Data</b> .....	18-17
<b>Inline Invariant Signals</b> .....	18-18

## Execution Speed

# 19

<b>Inline Parameters</b> .....	19-2
Referenced Models .....	19-3
<b>Configure Loop Unrolling Threshold</b> .....	19-4
<b>Optimize Code Generated for Vector Assignments</b> ....	19-6
Configure Model to Optimize Code Generated for Vector Assignments .....	19-6
Optimize Code Generated for Vector Assignments Using memcpy .....	19-7
<b>Generate Target Optimizations Within Algorithm Code</b> .....	19-10

## Memory Usage

# 20

<b>Minimize Memory Requirements During Code Generation</b> .....	20-2
<b>Implement Logic Signals as Boolean Data</b> .....	20-3
<b>Reduce Memory Requirements for Signals</b> .....	20-4
<b>Reuse Memory Allocated for Signals</b> .....	20-5

Use Stack Space Allocation .....	20-6
----------------------------------	------

## Verification

### Simulation and Code Comparison

## 21

Comparing Output Data .....	21-2
Configure Signal Data for Logging .....	21-3
Log Simulation Data .....	21-5
Log Data from the Generated Program .....	21-7
Compare Numerical Results .....	21-9

## Customization

### Build Process Integration

## 22

Control Build Process Compiling and Linking .....	22-2
Cross-Compile Code Generated on Microsoft Windows .....	22-4
Control Library Location and Naming During Build ..	22-7
Specify the Location of Precompiled Libraries .....	22-8
Control the Location of Model Reference Libraries .....	22-9
Control the Suffix Applied to Library File Names .....	22-10
Recompile Precompiled Libraries .....	22-12

<b>Customize Post-Code-Generation Build Processing</b> . . .	<b>22-13</b>
Build Information Object . . . . .	22-14
Program a Post Code Generation Command . . . . .	22-14
Define a Post Code Generation Command . . . . .	22-16
Suppress Makefile Generation . . . . .	22-17
<b>Configure Generated Code with TLC</b> . . . . .	<b>22-18</b>
About Configuring Generated Code with TLC . . . . .	22-18
Assigning Target Language Compiler Variables . . . . .	22-18
Set Target Language Compiler Options . . . . .	22-20
<b>Customize Build Process with STF_make_rtw_hook</b>	
<b>File</b> . . . . .	<b>22-21</b>
About the STF_make_rtw_hook File . . . . .	22-21
Conventions for Using the STF_make_rtw_hook File . . . . .	22-21
STF_make_rtw_hook.m Function Prototype and	
Arguments . . . . .	22-22
Applications for STF_make_rtw_hook.m . . . . .	22-25
Control Code Regeneration Using	
STF_make_rtw_hook.m . . . . .	22-26
Use STF_make_rtw_hook.m for Your Build Procedure . . .	22-27
<b>Customize Build Process with sl_customization.m</b> . . . . .	<b>22-28</b>
About sl_customization.m . . . . .	22-28
Register Build Process Hook Functions Using	
sl_customization.m . . . . .	22-30
Variables Available for sl_customization.m Hook	
Functions . . . . .	22-31
Example Build Process Customization Using	
sl_customization.m . . . . .	22-31
<b>Replace the STF_rtw_info_hook Mechanism</b> . . . . .	<b>22-33</b>
<b>Customize Build to Use Shared Utility Code</b> . . . . .	<b>22-34</b>
Modify Template Makefiles to Support Shared Utilities . .	22-35

<b>Customize an ASAP2 File</b> .....	<b>23-2</b>
About ASAP2 File Customization .....	23-2
ASAP2 File Structure on the MATLAB Path .....	23-2
Customize the Contents of the ASAP2 File .....	23-3
ASAP2 Templates .....	23-4
Use GROUP and SUBGROUP Hierarchies to Organize Signals and Parameters .....	23-6
Customize Computation Method Names .....	23-12
Suppress Computation Methods for FIX_AXIS .....	23-13
<b>Create a Transport Layer for External Communication</b> .....	<b>23-14</b>
About Creating a Transport Layer for External Communication .....	23-14
Design of External Mode .....	23-14
External Mode Communications Overview .....	23-17
External Mode Source Files .....	23-19
Implement a Custom Transport Layer .....	23-23

## Custom Target Development

<b>About Embedded Target Development</b> .....	<b>24-2</b>
Custom Targets .....	24-2
Types of Targets .....	24-2
Recommended Features for Embedded Targets .....	24-5
<b>Sample Custom Targets</b> .....	<b>24-9</b>
<b>Target Development Mechanics</b> .....	<b>24-11</b>
Folder and File Naming Conventions .....	24-11
Components of a Custom Target .....	24-12
Key Folders Under Target Root (mytarget) .....	24-17
Key Files in Target Folder (mytarget/mytarget) .....	24-20
Additional Files for Externally Developed Targets .....	24-28



Target Development and the Build Process .....	24-29
<b>Customize System Target Files .....</b>	<b>24-36</b>
Control Code Generation With the System Target File ...	24-36
System Target File Naming and Location Conventions ...	24-37
System Target File Structure .....	24-37
Define and Display Custom Target Options .....	24-46
Tips and Techniques for Customizing Your STF .....	24-54
Create a Custom Target Configuration .....	24-61
<b>Customize Template Makefiles .....</b>	<b>24-75</b>
Template Makefiles and Tokens .....	24-75
Invoke the make Utility .....	24-82
Structure of the Template Makefile .....	24-83
Customize and Create Template Makefiles .....	24-87
<b>Support Optional Features .....</b>	<b>24-100</b>
Overview .....	24-100
Support Model Referencing .....	24-101
Support Compiler Optimization Level Control .....	24-115
Support firstTime Argument Control .....	24-117
Support C Function Prototype Control .....	24-119
Support C++ Encapsulation Interface Control .....	24-121
<b>Interface to Development Tools .....</b>	<b>24-123</b>
About Interfacing to Development Tools .....	24-123
Makefile Approach .....	24-124
Interface to an Integrated Development Environment ....	24-124
<b>Device Drivers and Target Preferences .....</b>	<b>24-135</b>
Integrate Device Drivers .....	24-135
Use Target Preferences .....	24-135

# Desktop IDEs and Desktop Targets

## Project and Build Configurations for Desktop Targets

### 25

<b>Model Setup</b> .....	25-2
Block Selection .....	25-2
Target Preferences .....	25-3
Configuration Parameters .....	25-7
Model Reference .....	25-14
<b>IDE Projects</b> .....	25-16
Support for Third Party Products .....	25-16
Third Party Product Setup .....	25-16
Code Generation and Build .....	25-16
Automation of IDE Tasks and Processes .....	25-17
<b>Makefiles for Software Build Tool Chains</b> .....	25-19
What is the XMakefile Feature .....	25-19
Using Makefiles to Generate and Build Software .....	25-21
Making an XMakefile Configuration Operational .....	25-24
Working with Microsoft Visual Studio .....	25-24
Creating a New XMakefile Configuration .....	25-25
XMakefile User Configuration Dialog Box .....	25-31

## Verification Code Generated for Desktop Targets

### 26

<b>Processor-in-the-Loop (PIL) Simulation</b> .....	26-2
Overview .....	26-2
PIL Approaches .....	26-3
Communications .....	26-8
Running Your PIL Application to Perform Simulation and Verification .....	26-11
Definitions .....	26-11

## Working with Eclipse IDE

# 27

<b>Installing Third-Party Software for Eclipse</b> .....	27-2
Tested Software Versions .....	27-2
Installing Sun Java Runtime Environment (JRE) .....	27-3
Installing Eclipse IDE for C/C++ Developers .....	27-5
Verifying the GNU Tool Chain on Linux Host .....	27-6
Installing the GNU Tool Chain on Windows .....	27-7
<b>Configuring Your MathWorks Software to Work with Eclipse</b> .....	27-10
<b>Troubleshooting with Eclipse IDE</b> .....	27-14
SIGSEGV Segmentation Fault for GDB .....	27-14
GDB Stops on Each Semaphore Post .....	27-14
Build Errors .....	27-15
Profiling Not Available for Intel x86/Pentium and AMD K5/K6/Athlon Processors Running Windows or Linux Operating Systems .....	27-15
Eclipse Message: “Can’t find a source file” .....	27-15
Eclipse Message: “Cannot access memory at address” ....	27-16
Some Versions of Eclipse CDT Do Not Catch GCC Errors .....	27-16

## Working with Linux Target

# 28

<b>Disambiguation</b> .....	28-2
<b>Preparing Models to Run on Linux Target</b> .....	28-3
<b>Scheduler</b> .....	28-4

Base Rate .....	28-4
Running Target Applications on Multicore Processors ....	28-4
Running Multirate, Multitasking Executables on the Linux Desktop .....	28-11
Avoiding Lock-Up in Free-Running, Multirate, Multitasking Models .....	28-12

## Working with Microsoft Windows Target

# 29

<b>Preparing Models to Run on Windows</b> .....	29-2
<b>Scheduler</b> .....	29-3
Selecting the Operating System and Scheduling Mode ...	29-3
Base Rate .....	29-4
Running Target Applications on Multicore Processors ....	29-4
Limitations .....	29-10

## Examples

# A

<b>Models</b> .....	A-2
<b>Timing Services</b> .....	A-3
<b>Model Reference</b> .....	A-4
<b>Data Management</b> .....	A-5
<b>Custom Code</b> .....	A-6
<b>S-Functions</b> .....	A-7

<b>Optimizations</b> .....	<b>A-8</b>
<b>External Mode</b> .....	<b>A-9</b>
<b>Verification</b> .....	<b>A-10</b>
<b>Interfaces</b> .....	<b>A-11</b>
<b>Advanced Code Generation</b> .....	<b>A-12</b>
<b>Code Generation Using Makefiles</b> .....	<b>A-13</b>

## **Index**





# Model Architecture and Design

---

- Chapter 1, “Modeling”
- Chapter 2, “Subsystems”
- Chapter 3, “Referenced Models”
- Chapter 4, “Combined Models”
- Chapter 5, “Configure Model Parameters”
- Chapter 6, “Model Protection”





# Modeling

---

- “Configure a Model for Code Generation” on page 1-2
- “Scheduling” on page 1-4
- “Supported Products and Block Usage” on page 1-92
- “Modeling Semantic Considerations” on page 1-117

## Configure a Model for Code Generation

Model configuration parameters determine the method for generating the code and the resulting format.

- 1 Open `rtwdemo_throttlectrl` and save a copy as `throttlectrl` in a writable location on your MATLAB path.

---

**Note** This model uses Stateflow<sup>®</sup> software.

---

- 2 Open the Configuration Parameters dialog box Solver pane. To generate code for a model, you must configure the model to use a fixed-step solver. For this example, set the parameters as noted in the following table.

Parameter	Setting	Effect on Generated Code
Type	Fixed-step	Maintains a constant (fixed) step size, which is required for code generation
Solver	discrete (no continuous states)	Applies a fixed-step integration technique for computing the state derivative of the model
Fixed-step size	.001	Sets the base rate; must be the lowest common multiple of all rates in the system

Solver options

Type: Fixed-step Solver: discrete (no continuous states)

Fixed-step size (fundamental sample time): .001

- 3 Open the **Code Generation** pane and make sure that **System target file** is set to `grt.tlc`.

---

**Note** The GRT (Generic Real-Time Target) configuration requires a fixed-step solver. However, the `rsim.tlc` system target file supports variable step code generation.

---

The system target file (STF) defines a target, which is an environment for generating and building code for execution on a certain hardware or operating system platform. For example, one property of a target is code format. The `grt` configuration requires a fixed step solver and the `rsim.tlc` supports variable step code generation.

- 4 Open the **Code Generation > Custom Code** pane, and under **Include list of additional**, select **Include directories**. In the **Include directories** text field, enter:

```
"$matlabroot$\toolbox\rtw\rtwdemos\EmbeddedCoderOverview\"
```

This directory includes files that are required to build an executable for the model.

- 5 Apply your changes and close the dialog box.

## Scheduling

The following sections explain and illustrate how the Simulink® and Simulink Coder™ products handle multirate (mixed-rate) models, depending on whether code is being generated for single-tasking or multitasking environments.

<b>In this section...</b>
“About Scheduling” on page 1-4
“Single-Tasking and Multitasking Execution Modes” on page 1-5
“Handle Rate Transitions” on page 1-13
“Single-Tasking and Multitasking Model Execution” on page 1-27
“Handle Asynchronous Events” on page 1-34
“Timers” on page 1-79
“Configure Scheduling” on page 1-90

### About Scheduling

Simulink models run at one or more sample times. The Simulink product provides considerable flexibility in building multirate systems, that is, systems with more than one sample time. However, this same flexibility also allows you to construct models for which the code generator cannot generate real-time code for execution in a multitasking environment. To make multirate models operate as expected in real time (that is, to give the right answers), you sometimes must modify your model or instruct the Simulink engine to modify the model for you. In general, the modifications involve placing Rate Transition blocks between blocks that have unequal sample times. The following sections discuss issues you must address to use a multirate model in a multitasking environment. For a comprehensive discussion of sample times, including rate transitions, see “What Is Sample Time?”, “Sample Times in Subsystems”, “Sample Times in Systems”, “Resolve Rate Transitions”, and associated topics.

## Single-Tasking and Multitasking Execution Modes

- “About Tasking Modes” on page 1-5
- “Execute Multitasking Models” on page 1-6
- “Multitasking and Pseudomultitasking Modes” on page 1-8
- “Build a Program for Multitasking Execution” on page 1-10
- “Single-Tasking Mode” on page 1-10
- “Build a Program for Single-Tasking Execution” on page 1-11
- “Model Execution and Rate Transitions” on page 1-11
- “Simulate Models with the Simulink Product” on page 1-12
- “Execute Models in Real Time” on page 1-12
- “Single-Tasking Versus Multitasking Operation” on page 1-13

### About Tasking Modes

There are two execution modes for a fixed-step Simulink model: single-tasking and multitasking. These modes are available only for fixed-step solvers. To select an execution mode, use the **Tasking mode for periodic sample times** menu on the **Solver** pane of the Configuration Parameters dialog box. Auto mode (the default) applies multitasking execution for a multirate model, and otherwise selects single-tasking execution. You can also select `SingleTasking` or `MultiTasking` execution explicitly.

Execution of models in a real-time system can be done with the aid of a real-time operating system, or it can be done on a *bare-board* target, where the model runs in the context of an interrupt service routine (ISR).

The fact that a system (such as The Open Group UNIX<sup>®</sup> or Microsoft<sup>®</sup> Windows<sup>®</sup> systems) is multitasking does not imply that your program can execute in real time. This is because the program might not preempt other processes when required.

In operating systems (such as PC-DOS) where only one process can exist at any given time, an interrupt service routine (ISR) must perform the steps of saving the processor context, executing the model code, collecting data, and restoring the processor context.

Other operating systems, such as POSIX-compliant ones, provide automatic context switching and task scheduling. This simplifies the operations performed by the ISR. In this case, the ISR simply enables the model execution task, which is normally blocked. The next figure illustrates this difference.

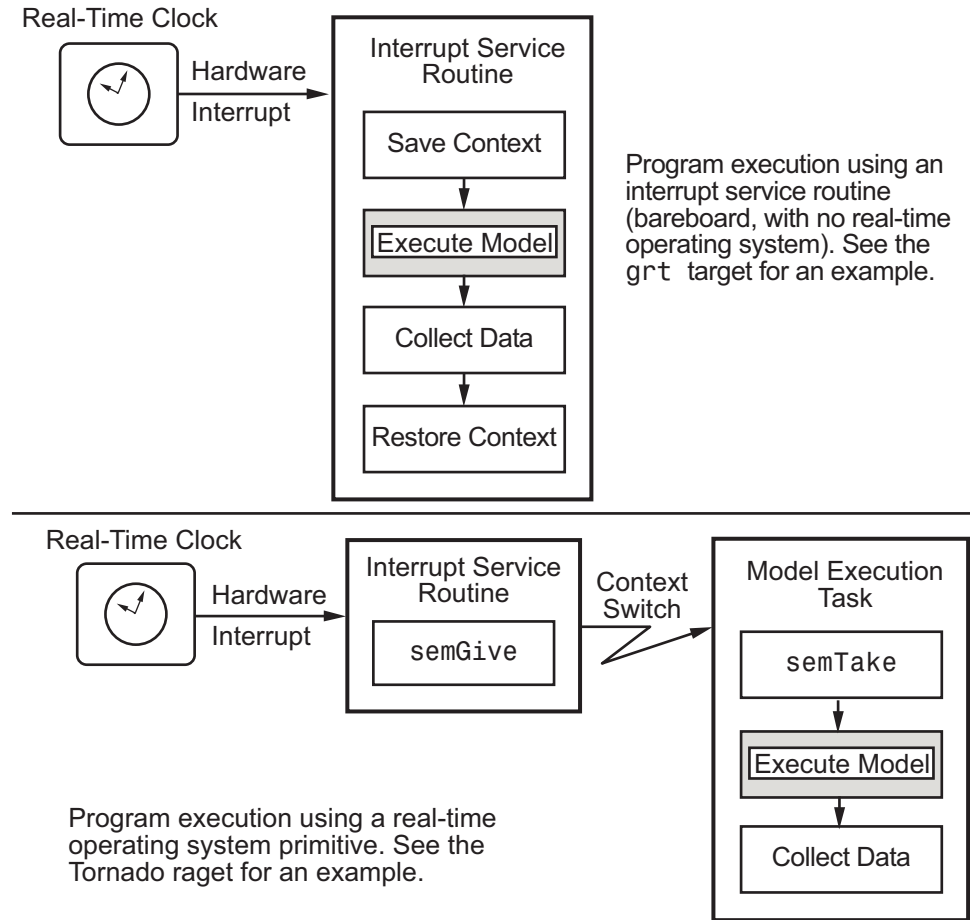

### Execute Multitasking Models

In cases where the continuous part of a model executes at a rate that is different from the discrete part, or a model has blocks with different sample

rates, the Simulink engine assigns each block a *task identifier* (*tid*) to associate the block with the task that executes at the block's sample rate.

You set sample rates and their constraints on the **Solver** pane of the Configuration Parameters dialog box. To generate code with the Simulink Coder software, you must select **Fixed-step** for the solver type. Certain restrictions apply to the sample rates that you can use:

- The sample rate of any block must be an integer multiple of the base (that is, the fastest) sample period.
- When **Periodic sample time constraint** is unconstrained, the base sample period is determined by the **Fixed step size** specified on the **Solvers** pane of the Configuration parameters dialog box.
- When **Periodic sample time constraint** is Specified, the base rate fixed-step size is the first element of the sample time matrix that you specify in the companion option **Sample time properties**. The **Solver** pane from the example model `rtwdemo_mrmtbb` shows an example.

Simulation time

Start time:  Stop time:

Solver options

Type:  Solver:

Fixed-step size (fundamental sample time):

Tasking and sample time options

Periodic sample time constraint:

Sample time properties:

Tasking mode for periodic sample times:

Automatically handle rate transition for data transfer

Higher priority value indicates higher task priority

- Continuous blocks always execute by using an integration algorithm that runs at the base sample rate. The base sample period is the greatest common denominator of all rates in the model only when **Periodic sample time constraint** is set to Unconstrained and **Fixed step size** is Auto.
- The continuous and discrete parts of the model can execute at different rates only if the discrete part is executed at the same or a slower rate than the continuous part and is an integer multiple of the base sample rate.

### **Multitasking and Pseudomultitasking Modes**

When periodic tasks execute in a multitasking mode, by default the blocks with the fastest sample rates are executed by the task with the highest priority, the next fastest blocks are executed by a task with the next higher priority, and so on. Time available in between the processing of high-priority tasks is used for processing lower priority tasks. This results in efficient program execution.

Where tasks are asynchronous rather than periodic, there may not necessarily be a relationship between sample rates and task priorities; the task with the highest priority need not have the fastest sample rate. You specify asynchronous task priorities using Async Interrupt and Task Sync blocks. You can switch the sense of what priority numbers mean by selecting or deselecting the Solver option **Higher priority value indicates higher task priority**.

In multitasking environments (that is, under a real-time operating system), you can define separate tasks and assign them priorities. In a bare-board target (that is, no real-time operating system present), you cannot create separate tasks. However, Simulink Coder application modules implement what is effectively a multitasking execution scheme using overlapped interrupts, accompanied by programmatic context switching.

This means an interrupt can occur while another interrupt is currently in progress. When this happens, the current interrupt is preempted, the floating-point unit (FPU) context is saved, and the higher priority interrupt executes its higher priority (that is, faster sample rate) code. Once complete, control is returned to the preempted ISR.



The next figures illustrate how timing of tasks in multirate systems are handled by the Simulink Coder software in multitasking, pseudomultitasking, and single-tasking environments.

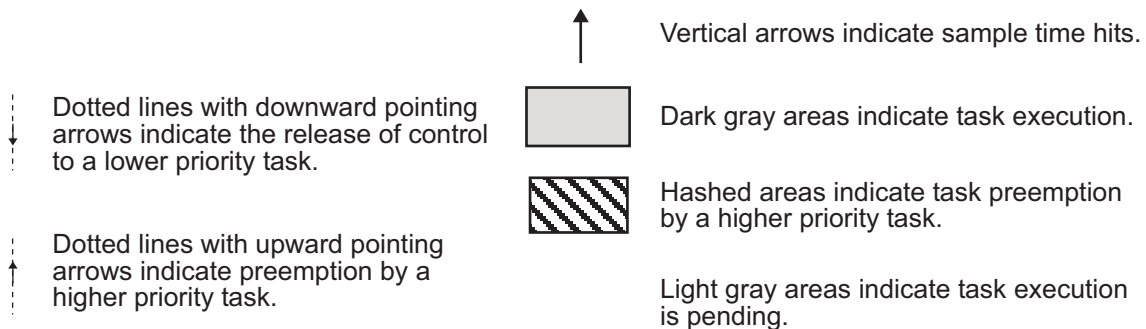
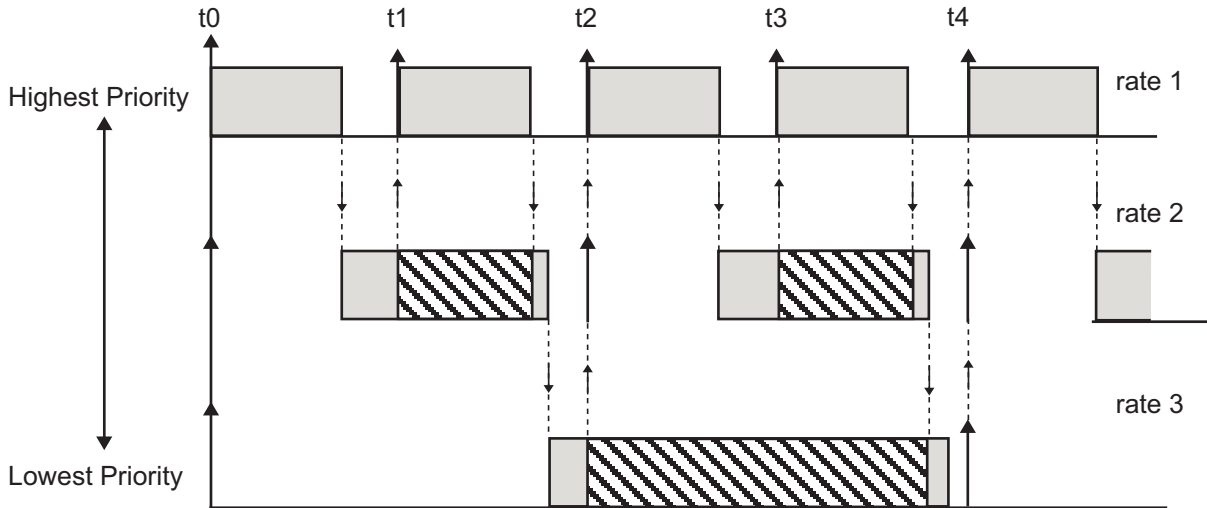

The next figure shows how overlapped interrupts are used to implement pseudomultitasking. In this case, Interrupt 0 does not return until after Interrupts 1, 2, and 3.

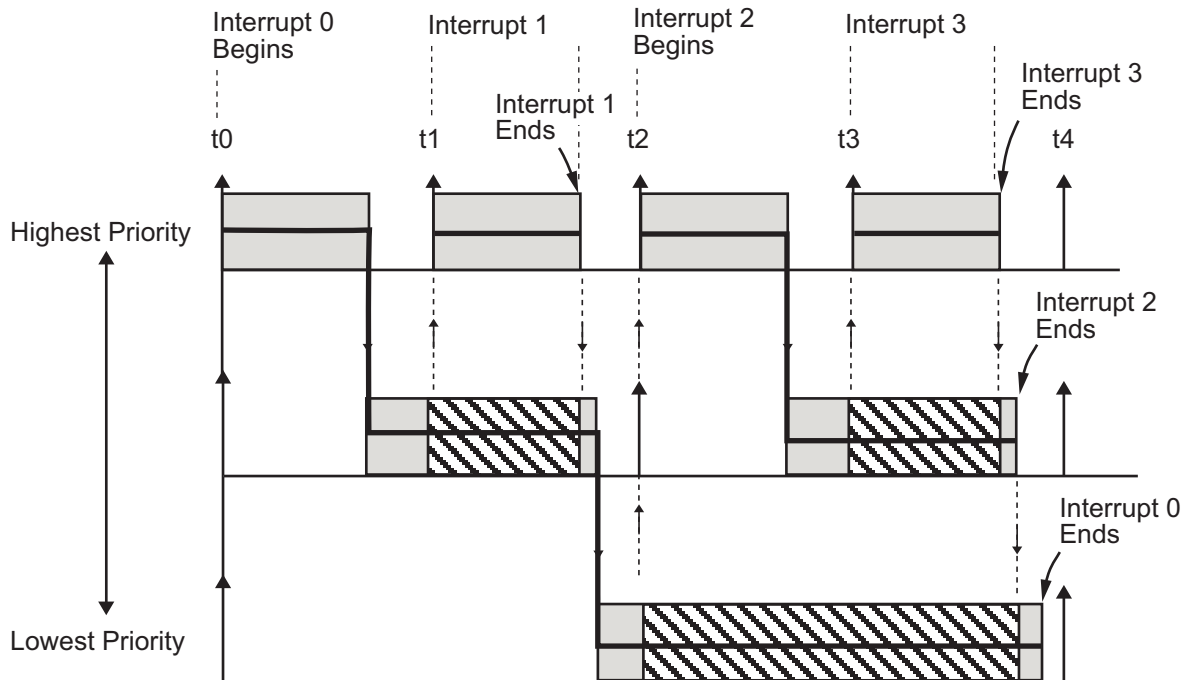

## Build a Program for Multitasking Execution

To use multitasking execution, select **Auto** (the default) or **MultiTasking** from the **Tasking mode for periodic sample times** menu on the **Solver** pane of the Configuration Parameters dialog box. This menu is active only if you select **Fixed-step** as the solver type. **Auto** mode results in a multitasking environment if your model has two or more different sample times. A model with a continuous and a discrete sample time runs in single-tasking mode if the fixed-step size is equal to the discrete sample time.

## Single-Tasking Mode

You can execute model code in a strictly single-tasking manner. While this mode is less efficient with regard to execution speed, in certain situations, it can simplify your model.

In single-tasking mode, the base sample rate must define a time interval that is long enough to allow the execution of all blocks within that interval.

The next figure illustrates the inefficiency inherent in single-tasking execution.

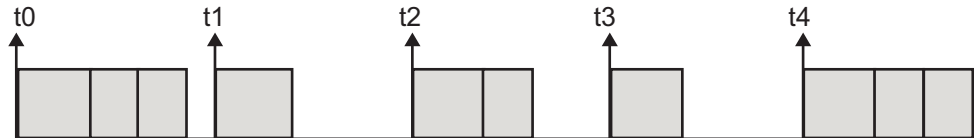

Single-tasking system execution requires a base sample rate that is long enough to execute one step through the entire model.

### Build a Program for Single-Tasking Execution

To use single-tasking execution, select `SingleTasking` from the **Tasking mode for periodic sample times** menu on the **Solver** pane of the Configuration Parameters dialog box. If you select `Auto`, single-tasking is used in the following cases:

- If your model contains one sample time
- If your model contains a continuous and a discrete sample time and the fixed step size is equal to the discrete sample time

### Model Execution and Rate Transitions

To generate code that executes as expected in real time, you (or the Simulink engine) might need to identify and handle sample rate transitions within the model. In multitasking mode, by default the Simulink engine flags errors during simulation if the model contains invalid rate transitions, although you can use the **Multitask rate transition** diagnostic to alter this behavior. A similar diagnostic, called **Single task rate transition**, exists for single-tasking mode.

To avoid raising rate transition errors, insert Rate Transition blocks between tasks. You can request that the Simulink engine handle rate transitions automatically by inserting hidden Rate Transition blocks. See “Automatic Rate Transition” on page 1-20 for an explanation of this option.

To understand such problems, first consider how Simulink simulations differ from real-time programs.

## Simulate Models with the Simulink Product

Before the Simulink engine simulates a model, it orders the blocks based upon their topological dependencies. This includes expanding virtual subsystems into the individual blocks they contain and flattening the entire model into a single list. Once this step is complete, each block is executed in order.

The key to this process is the ordering of blocks. Any block whose output is directly dependent on its input (that is, any block with direct feedthrough) cannot execute until the block driving its input executes.

Some blocks set their outputs based on values acquired in a previous time step or from initial conditions specified as a block parameter. The output of such a block is determined by a value stored in memory, which can be updated independently of its input. During simulation, computations are performed prior to advancing the variable corresponding to time. In essence, this results in computations occurring instantaneously (that is, no computational delay).

## Execute Models in Real Time

A real-time program differs from a Simulink simulation in that the program must execute the model code synchronously with real time. Every calculation results in some computational delay. This means the sample intervals cannot be shortened or lengthened (as they can be in a Simulink simulation), which leads to less efficient execution.

Consider the following timing figure.

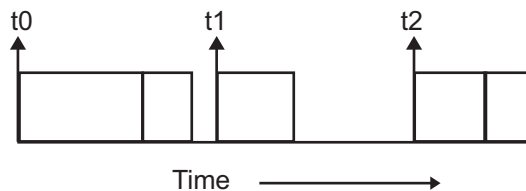

Note the processing inefficiency in the sample interval  $t_1$ . That interval cannot be compressed to increase execution speed because, by definition, sample times are clocked in real time.

You can circumvent this potential inefficiency by using the multitasking mode. The multitasking mode defines tasks with different priorities to execute parts of the model code that have different sample rates.

See “Multitasking and Pseudomultitasking Modes” on page 1-8 for a description of how this works. It is important to understand that section before proceeding here.

## Single-Tasking Versus Multitasking Operation

Single-tasking programs require longer sample intervals, because all computations must be executed within each clock period. This can result in inefficient use of available CPU time, as shown in the previous figure.

Multitasking mode can improve the efficiency of your program if the model is large and has many blocks executing at each rate.

However, if your model is dominated by a single rate, and only a few blocks execute at a slower rate, multitasking can actually degrade performance. In such a model, the overhead incurred in task switching can be greater than the time required to execute the slower blocks. In this case, it is more efficient to execute all blocks at the dominant rate.

If you have a model that can benefit from multitasking execution, you might need to modify your model by adding Rate Transition blocks (or instruct the Simulink engine to do so) to generate expected results. The next section, “Handle Rate Transitions” on page 1-13, discusses issues related to rate transition blocks.

## Handle Rate Transitions

- “About Rate Transitions” on page 1-14
- “Data Transfer Problems” on page 1-15
- “Data Transfer Assumptions” on page 1-16
- “Rate Transition Block Options” on page 1-17
- “Faster to Slower Transitions in a Simulink Model” on page 1-22
- “Faster to Slower Transitions in Real Time” on page 1-23

- “Slower to Faster Transitions in a Simulink Model” on page 1-24
- “Slower to Faster Transitions in Real Time” on page 1-25

## About Rate Transitions

Two periodic sample rate transitions can exist within a model:

- A faster block driving a slower block
- A slower block driving a faster block

The following sections concern models with periodic sample times with zero offset only. Other considerations apply to multirate models that involve asynchronous tasks. For details on how to generate code for asynchronous multitasking, see “Handle Asynchronous Events” on page 1-34.

In single-tasking systems, there are no issues involving multiple sample rates. In multitasking and pseudomultitasking systems, however, differing sample rates can cause problems by causing blocks to be executed in the wrong order. To prevent possible errors in calculated data, you must control model execution at these transitions. When connecting faster and slower blocks, you or the Simulink engine must add Rate Transition blocks between them. Fast-to-slow transitions are illustrated in the next figure.

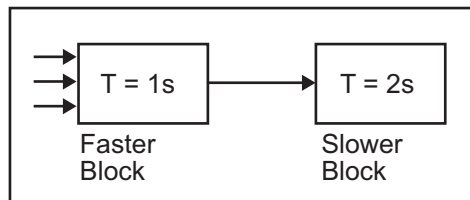

becomes

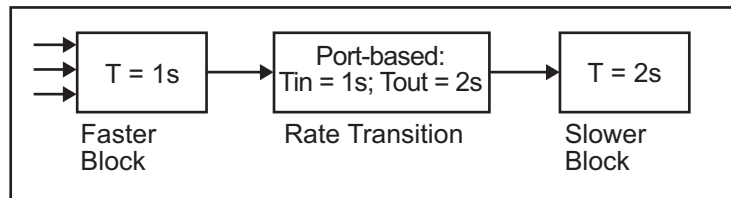

Slow-to-fast transitions are illustrated in the next figure.

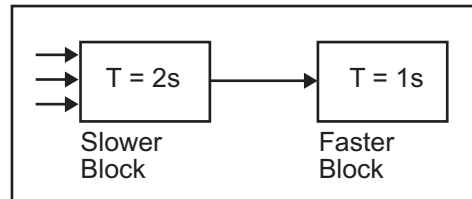

becomes

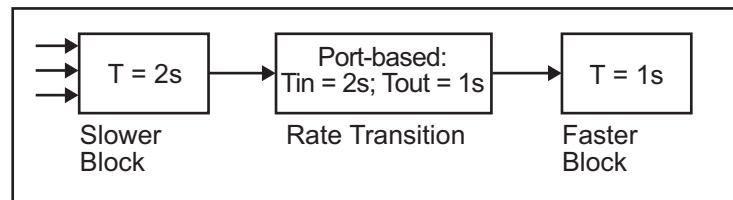

---

**Note** Although the Rate Transition block offers a superset of the capabilities of the Unit Delay block (for slow-to-fast transitions) and the Zero-Order Hold block (for fast-to-slow transitions), you should use the Rate Transition block instead of these blocks.

---

## Data Transfer Problems

Rate Transition blocks deal with issues of data integrity and determinism associated with data transfer between blocks running at different rates.

- *Data integrity*: A problem of data integrity exists when the input to a block changes during the execution of that block. Data integrity problems can be caused by preemption.

Consider the following scenario:

- A faster block supplies the input to a slower block.
- The slower block reads an input value  $V_1$  from the faster block and begins computations using that value.

- The computations are preempted by another execution of the faster block, which computes a new output value  $V_2$ .
- A data integrity problem now arises: when the slower block resumes execution, it continues its computations, now using the “new” input value  $V_2$ .

Such a data transfer is called *unprotected*. “Faster to Slower Transitions in Real Time” on page 1-23 shows an unprotected data transfer.

In a *protected* data transfer, the output  $V_1$  of the faster block is held until the slower block finishes executing.

- *Deterministic* versus *nondeterministic* data transfer: In a *deterministic* data transfer, the timing of the data transfer is completely predictable, as determined by the sample rates of the blocks.

The timing of a *nondeterministic* data transfer depends on the availability of data, the sample rates of the blocks, and the time at which the receiving block begins to execute relative to the driving block.

You can use the Rate Transition block to protect data transfers in your application and make them deterministic. These characteristics are considered desirable in most applications. However, the Rate Transition block supports flexible options that allow you to compromise data integrity and determinism in favor of lower latency. The next section summarizes these options.

## Data Transfer Assumptions

When processing data transfers between tasks, the Simulink Coder software assumes the following:

- Data transitions occur between a single reading task and a single writing task.
- A read or write of a byte-sized variable is atomic.
- When two tasks interact through a data transition, only one of them can preempt the other.
- For periodic tasks, the faster rate task has higher priority than the slower rate task; the faster rate task always preempts the slower rate task.



- All tasks run on a single processor. Time slicing is not allowed.
- Processes do not crash or restart (especially while data is transferred between tasks).

### **Rate Transition Block Options**

Several parameters of the Rate Transition block are relevant to its use in code generation for real-time execution, as discussed below. For a complete block description, see Rate Transition in the Simulink documentation.

The Rate Transition block handles periodic (fast to slow and slow to fast) and asynchronous transitions. When inserted between two blocks of differing sample rates, the Rate Transition block automatically configures its input and output sample rates for the type of transition; you do not need to specify whether a transition is slow-to-fast or fast-to-slow (low-to-high or high-to-low priorities for asynchronous tasks).

The critical decision you must make in configuring a Rate Transition block is the choice of data transfer mechanism to be used between the two rates. Your choice is dictated by considerations of safety, memory usage, and performance. As the Rate Transition block parameter dialog box in the next figure shows, the data transfer mechanism is controlled by two options.

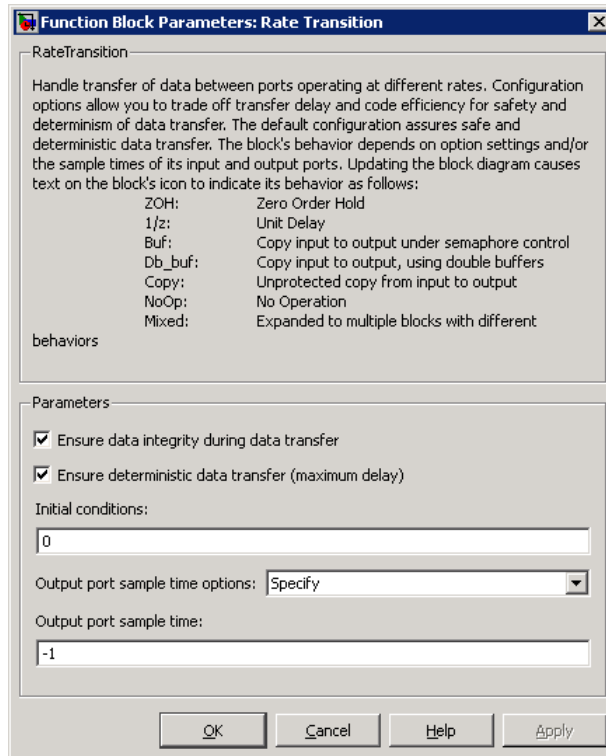

- **Ensure data integrity during data transfer:** When this option is on, data transferred between rates maintains its integrity (the data transfer is protected). When this option is off, the data might not maintain its integrity (the data transfer is unprotected). By default, **Ensure data integrity during data transfer** is on.
- **Ensure deterministic data transfer (maximum delay):** This option is supported for periodic tasks with an offset of zero and fast and slow rates that are multiples of each other. Enable this option for protected data transfers (when **Ensure data integrity during data transfer** is on). When this option is on, the Rate Transition block behaves like a Zero-Order Hold block (for fast to slow transitions) or a Unit Delay block (for slow to fast transitions). The Rate Transition block controls the timing of data transfer in a completely predictable way. When this option is off, the data transfer is nondeterministic. By default, **Ensure deterministic data**

**transfer (maximum delay)** is on for transitions between periodic rates with an offset of zero; for asynchronous transitions, it cannot be selected.

Thus the Rate Transition block offers three modes of operation with respect to data transfer. In order of level of safety:

- **Protected/Deterministic (default):** This is the safest mode. The drawback of this mode is that it introduces deterministic latency into the system for the case of slow-to-fast periodic rate transitions. For that case, the latency introduced by the Rate Transition block is one sample period of the slower task. For the case of fast-to-slow periodic rate transitions, the Rate Transition block introduces no additional latency.
- **Protected/NonDeterministic:** In this mode, for slow-to-fast periodic rate transitions, data integrity is protected by double-buffering data transferred between rates. For fast-to-slow periodic rate transitions, a semaphore flag is used. The blocks downstream from the Rate Transition block always use the latest available data from the block that drives the Rate Transition block. Maximum latency is less than or equal to one sample period of the faster task.

The drawbacks of this mode are its nondeterministic timing. The advantage of this mode is its low latency.

- **Unprotected/NonDeterministic:** This mode is not recommended for mission-critical applications. The latency of this mode is the same as for Protected/NonDeterministic mode, but memory requirements are reduced since neither double-buffering nor semaphores are required. That is, the Rate Transition block does nothing in this mode other than to pass signals through; it simply exists to notify you that a rate transition exists (and can cause generated code to compute incorrect answers). Selecting this mode, however, generates the least amount of code.

---

**Note** In unprotected mode (**Ensure data integrity during data transfer** option off), the Rate Transition block does nothing other than allow the rate transition to exist in the model.

---

**Automatic Rate Transition.** The Simulink engine can detect mismatched rate transitions in a multitasking model and automatically insert Rate Transition blocks to handle them. To instruct the engine to do this, select **Automatically handle rate transition for data transfer** on the **Solver** pane of the Configuration Parameters dialog box.

The **Automatically handle rate transition for data transfer** option is off by default. When you select it,

- The Simulink engine handles transitions between periodic sample times and asynchronous tasks.
- The Simulink engine inserts “hidden” Rate Transition blocks that are not visible on the block diagram.
- The Simulink Coder software generates code for the automatically inserted Rate Transition blocks that is identical to that generated for manually inserted Rate Transition blocks.
- Automatically inserted Rate Transition blocks operate in protected mode for periodic tasks and asynchronous tasks, which you cannot alter. For periodic tasks, automatically inserted Rate Transition blocks operate with the level of determinism specified by the **Solver** pane parameter **Deterministic data transfer**. (The default setting is *Whenever possible*, which enables determinism for data transfers between periodic sample-times that are related by an integer multiple; for more information, see “Deterministic data transfer” in the Simulink reference documentation.) To use other modes, you must insert Rate Transition blocks and set their modes manually.

For example, in the following model **SineWave2** has a **Sample time** of 2, and **SineWave3** has a **Sample time** of 3.

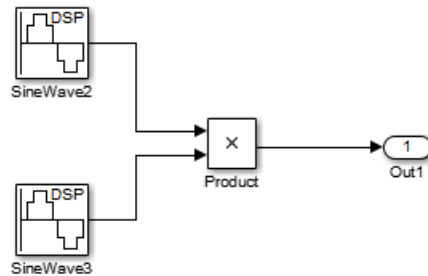

If **Automatically handle rate transition for data transfer** is on, the Simulink engine inserts an invisible Rate Transition block between each Sine Wave block and the Product block. The inserted blocks have the parameter values required to reconcile the Sine Wave block sample times.

### Inserted Rate Transition Block HTML Report

When the Simulink engine has automatically inserted Rate Transition blocks into a model, after code generation the optional HTML code generation report includes a **List of inserted blocks** that describes the blocks. For example, the following report describes the two Rate Transition blocks that the engine automatically inserts into the previous model.

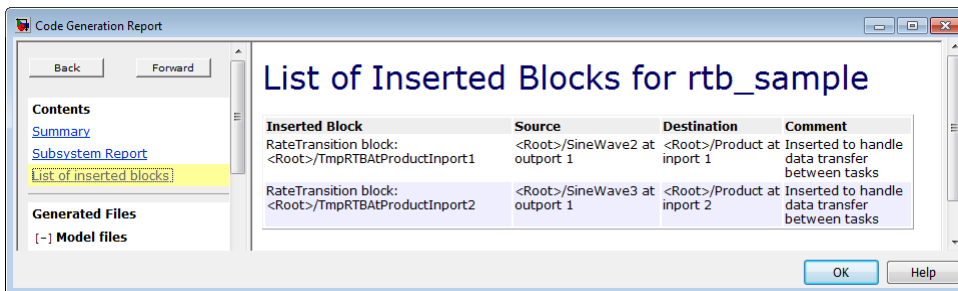

Only automatically inserted Rate Transition blocks appear in a **List of inserted blocks**. If no such blocks exist in a model, the HTML code generation report does not include a **List of inserted blocks**.

**Rate Transition Blocks and Continuous Time.** The sample time at the output port of a Rate Transition block can only be discrete or fixed in minor time step. This means that when a Rate Transition block inherits continuous sample time from its destination block, it treats the inherited sample time as Fixed in Minor Time Step. Therefore, the output function of the Rate Transition block runs only at major time steps. If the destination block sample time is continuous, Rate Transition block output sample time is the base rate sample time (if solver is fixed-step), or zero-order-hold-continuous sample time (if solver is variable-step).

The next four sections describe cases in which Rate Transition blocks are required for periodic sample rate transitions. The discussion and timing diagrams in these sections are based on the assumption that the Rate Transition block is used in its default (protected/deterministic) mode; that is, the **Ensure data integrity during data transfer** and **Ensure deterministic data transfer (maximum delay)** options are both on. These are the settings used for automatically inserted Rate Transition blocks.

### Faster to Slower Transitions in a Simulink Model

In a model where a faster block drives a slower block having direct feedthrough, the outputs of the faster block are always computed first. In simulation intervals where the slower block does not execute, the simulation progresses more rapidly because there are fewer blocks to execute. The next figure illustrates this situation.

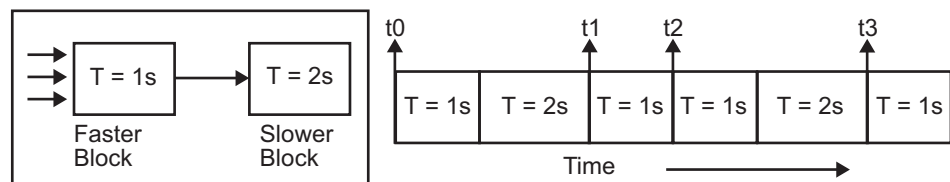

A Simulink simulation does not execute in real time, which means that it is not bound by real-time constraints. The simulation waits for, or moves ahead to, whatever tasks are required to complete simulation flow. The actual time interval between sample time steps can vary.

### Faster to Slower Transitions in Real Time

In models where a faster block drives a slower block, you must compensate for the fact that execution of the slower block might span more than one execution period of the faster block. This means that the outputs of the faster block can change before the slower block has finished computing its outputs. The next figure shows a situation in which this problem arises ( $T = \text{sample time}$ ). Note that lower priority tasks are preempted by higher priority tasks before completion.

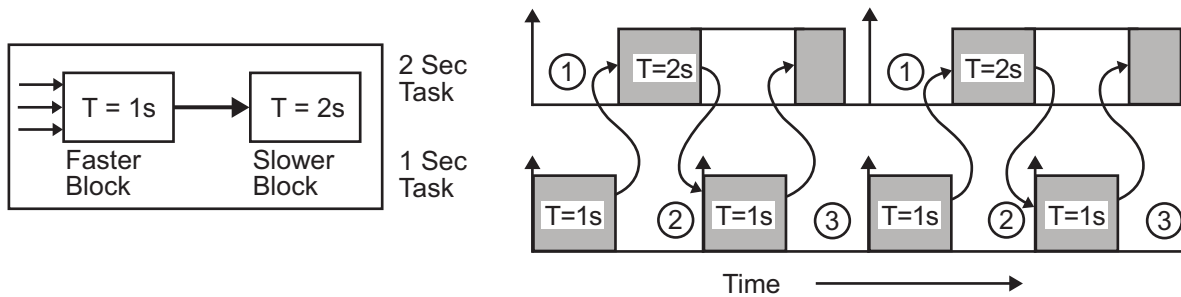

- ① The faster task ( $T=1s$ ) completes.
- ② Higher priority preemption occurs.
- ③ The slower task ( $T=2s$ ) resumes and its inputs have changed. This leads to unpredictable results.

In the above figure, the faster block executes a second time before the slower block has completed execution. This can cause unpredictable results because the input data to the slow task is changing. Data might not maintain its integrity in this situation.

To avoid this situation, the Simulink engine must hold the outputs of the 1 second (faster) block until the 2 second (slower) block finishes executing. The way to accomplish this is by inserting a Rate Transition block between the 1 second and 2 second blocks. The input to the slower block does not change during its execution, maintaining data integrity.

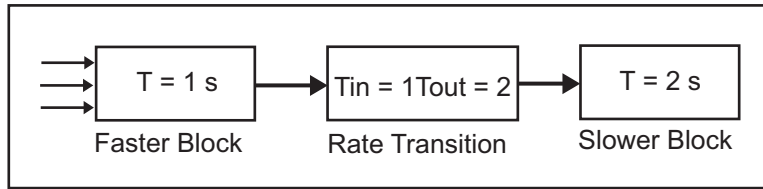

It is assumed that the Rate Transition block is used in its default (protected/deterministic) mode.

The Rate Transition block executes at the sample rate of the slower block, but with the priority of the faster block.

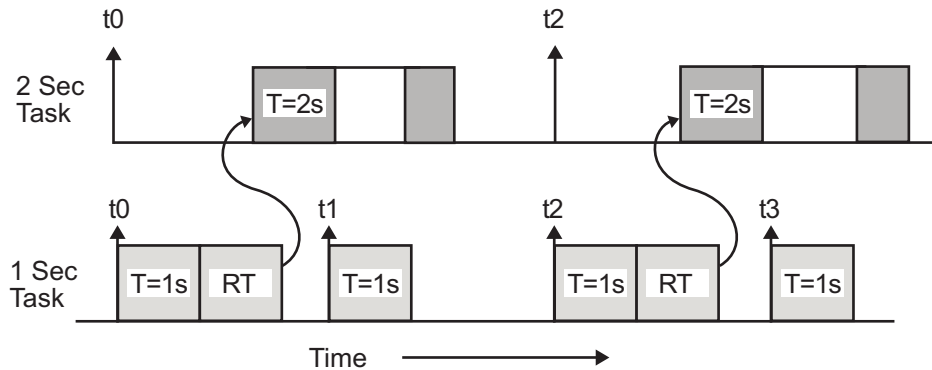

When you add a Rate Transition block, the block executes before the 2 second block (its priority is higher) and its output value is held constant while the 2 second block executes (it executes at the slower sample rate).

### Slower to Faster Transitions in a Simulink Model

In a model where a slower block drives a faster block, the Simulink engine again computes the output of the driving block first. During sample intervals where only the faster block executes, the simulation progresses more rapidly.

The next figure shows the execution sequence.



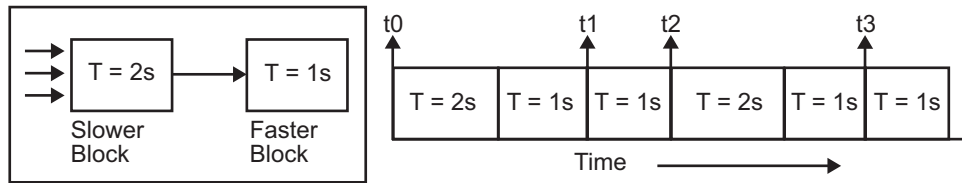

As you can see from the preceding figures, the Simulink engine can simulate models with multiple sample rates in an efficient manner. However, a Simulink simulation does not operate in real time.

### Slower to Faster Transitions in Real Time

In models where a slower block drives a faster block, the generated code assigns the faster block a higher priority than the slower block. This means the faster block is executed before the slower block, which requires special care to avoid incorrect results.

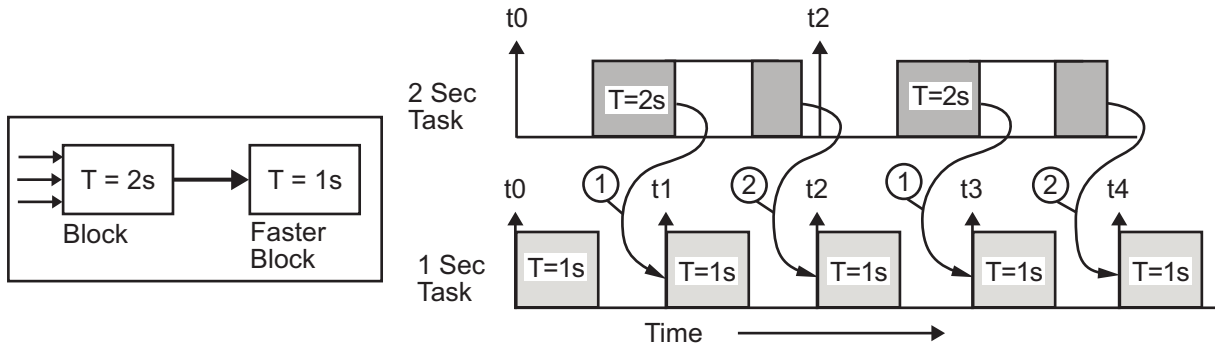

- ① The faster block executes a second time prior to the completion of the slower block.
- ② The faster block executes before the slower block.

This timing diagram illustrates two problems:

- Execution of the slower block is split over more than one faster block interval. In this case the faster task executes a second time before the

slower task has completed execution. This means the inputs to the faster task can have incorrect values some of the time.

- The faster block executes before the slower block (which is backward from the way a Simulink simulation operates). In this case, the 1 second block executes first; but the inputs to the faster task have not been computed. This can cause unpredictable results.

To eliminate these problems, you must insert a Rate Transition block between the slower and faster blocks.

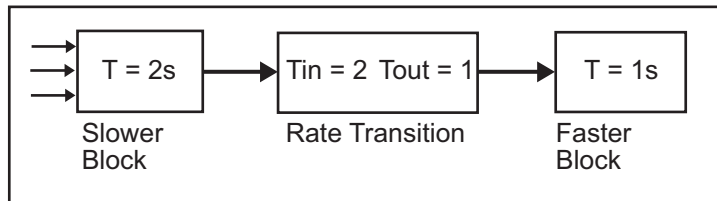

It is assumed that the Rate Transition block is used in its default (protected/deterministic) mode.

The next figure shows the timing sequence that results with the added Rate Transition block.

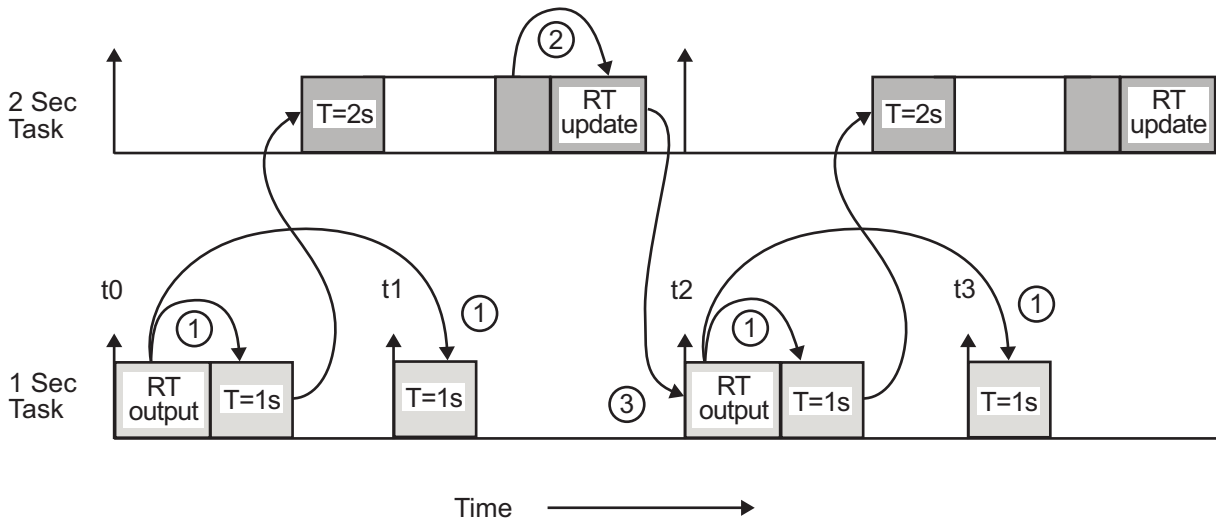

Three key points about transitions in this diagram (refer to circled numbers):

- 1** The Rate Transition block output runs in the 1 second task, but at a slower rate (2 seconds). The output of the Rate Transition block feeds the 1 second task blocks.
- 2** The Rate Transition update uses the output of the 2 second task to update its internal state.
- 3** The Rate Transition output in the 1 second task uses the state of the Rate Transition that was updated in the 2 second task.

The first problem is alleviated because the Rate Transition block is updating at a slower rate and at the priority of the slower block. The input to the Rate Transition block (which is the output of the slower block) is read after the slower block completes executing.

The second problem is alleviated because the Rate Transition block executes at a slower rate and its output does not change during the computation of the faster block it is driving. The output portion of a Rate Transition block is executed at the sample rate of the slower block, but with the priority of the faster block. Since the Rate Transition block drives the faster block and has effectively the same priority, it is executed before the faster block.

---

**Note** This use of the Rate Transition block changes the model. The output of the slower block is now delayed by one time step compared to the output without a Rate Transition block.

---

## Single-Tasking and Multitasking Model Execution

- “Introduction” on page 1-28
- “Single-Tasking Execution” on page 1-28
- “Multitasking Execution” on page 1-31

## Introduction

This section examines how a simple multirate model executes in both real time and simulation, using a fixed-step solver. It considers the operation of both **SingleTasking** and **MultiTasking Solver** pane tasking modes.

The example model is shown in the next figure. The discussion refers to the six blocks of the model as A through F, as labeled in the block diagram.

The execution order of the blocks (indicated in the upper right of each block) has been forced into the order shown by assigning higher priorities to blocks F, E, and D. The ordering shown is one possible valid execution ordering for this model. (See “Simulating Dynamic Systems” in the Simulink documentation.)

The execution order is determined by data dependencies between blocks. In a real-time system, the execution order determines the order in which blocks execute within a given time interval or task. This discussion treats the model’s execution order as a given, because it is concerned with the allocation of block computations to tasks, and the scheduling of task execution.

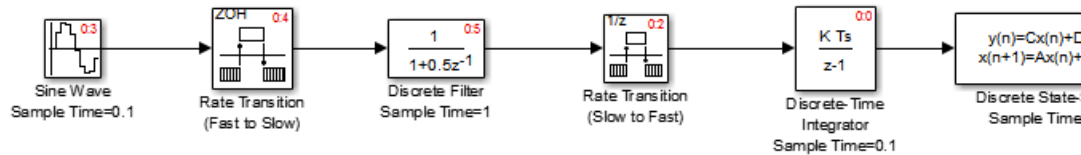

---

**Note** The discussion and timing diagrams in this section are based on the assumption that the Rate Transition blocks are used in the default (protected/deterministic) mode, with the **Ensure data integrity during data transfer** and **Ensure deterministic data transfer (maximum delay)** options on.

---

## Single-Tasking Execution

This section considers the execution of the above model when the solver **Tasking mode** is **SingleTasking**.

In a single-tasking system, if the **Block reduction** option on the **Optimization** pane is on, fast-to-slow Rate Transition blocks are optimized out of the model. The default case is shown (**Block reduction** on), so block B does not appear in the timing diagrams in this section. For more information, see “Block reduction”.

The following table shows, for each block in the model, the execution order, sample time, and whether the block has an output or update computation. Block A does not have discrete states, and accordingly does not have an update computation.

### Execution Order and Sample Times (Single-Tasking)

Blocks (in Execution Order)	Sample Time (in Seconds)	Output	Update
F	0.1	Y	Y
E	0.1	Y	Y
D	1	Y	Y
A	0.1	Y	N
C	1	Y	Y

**Real-Time Single-Tasking Execution.** The next figure shows the scheduling of computations when the generated code is deployed in a real-time system. The generated program is shown running in real time, under control of interrupts from a 10 Hz timer.

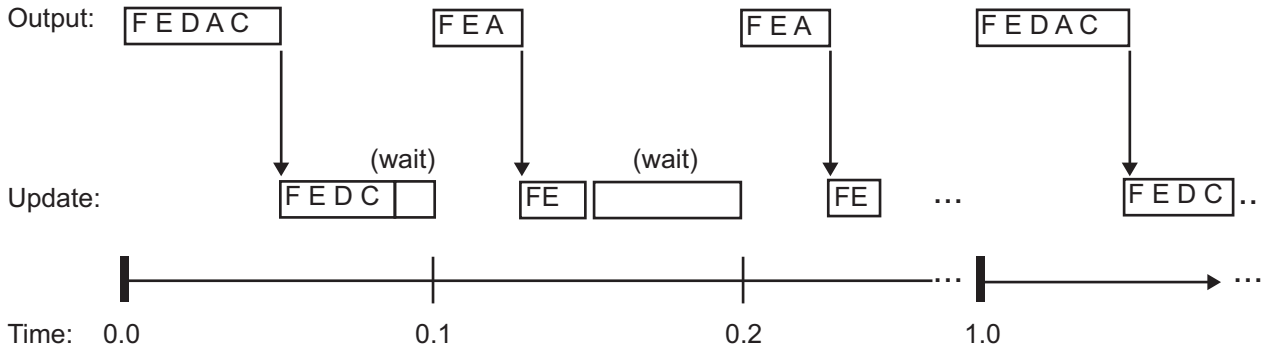

At time 0.0, 1.0, and every second thereafter, both the slow and fast blocks execute their output computations; this is followed by update computations for blocks that have states. Within a given time interval, output and update computations are sequenced in block execution order.

The fast blocks execute on every tick, at intervals of 0.1 second. Output computations are followed by update computations.

The system spends some portion of each time interval (labeled “wait”) idling. During the intervals when only the fast blocks execute, a larger portion of the interval is spent idling. This illustrates an inherent inefficiency of single-tasking mode.

**Simulated Single-Tasking Execution.** The next figure shows the execution of the model during the Simulink simulation loop.

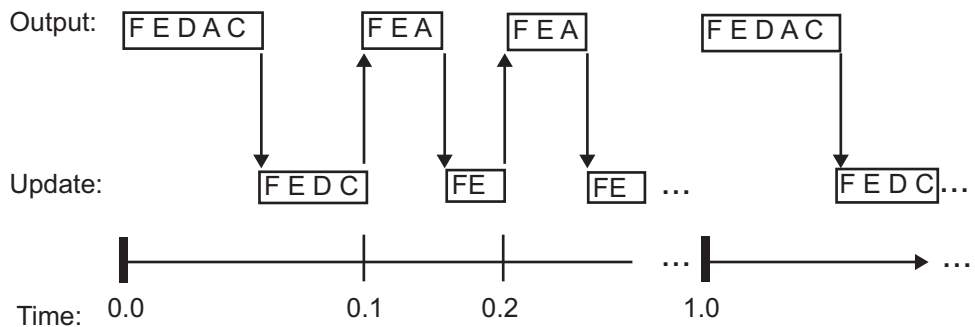

Because time is simulated, the placement of ticks represents the iterations of the simulation loop. Blocks execute in exactly the same order as in the previous figure, but without the constraint of a real-time clock. Therefore there is no idle time between simulated sample periods.

### Multitasking Execution

This section considers the execution of the above model when the solver **Tasking mode** is `MultiTasking`. Block computations are executed under two tasks, prioritized by rate:

- The slower task, which gets the lower priority, is scheduled to run every second. This is called the *1 second task*.
- The faster task, which gets higher priority, is scheduled to run 10 times per second. This is called the *0.1 second task*. The 0.1 second task can preempt the 1 second task.

The following table shows, for each block in the model, the execution order, the task under which the block runs, and whether the block has an output or update computation. Blocks A and B do not have discrete states, and accordingly do not have an update computation.

### Task Allocation of Blocks in Multitasking Execution

Blocks (in Execution Order)	Task	Output	Update
F	0.1 second task	Y	Y
E	0.1 second task	Y	Y

**Task Allocation of Blocks in Multitasking Execution (Continued)**

<b>Blocks (in Execution Order)</b>	<b>Task</b>	<b>Output</b>	<b>Update</b>
D	The Rate Transition block uses port-based sample times. Output runs at the output port sample time under 0.1 second task. Update runs at input port sample time under 1 second task. For more information on port-based sample times, see “Inherit Sample Times” in the Simulink documentation.	Y	Y
A	0.1 second task	Y	N
B	The Rate Transition block uses port-based sample times. Output runs at the output port sample time under 0.1 second task. For more information on port-based sample times, see “Inherit Sample Times” in the Simulink documentation.	Y	N
C	1 second task	Y	Y

**Real-Time Multitasking Execution.** The next figure shows the scheduling of computations in MultiTasking solver mode when the generated code is deployed in a real-time system. The generated program is shown running in real time, as two tasks under control of interrupts from a 10 Hz timer.



1 SECOND

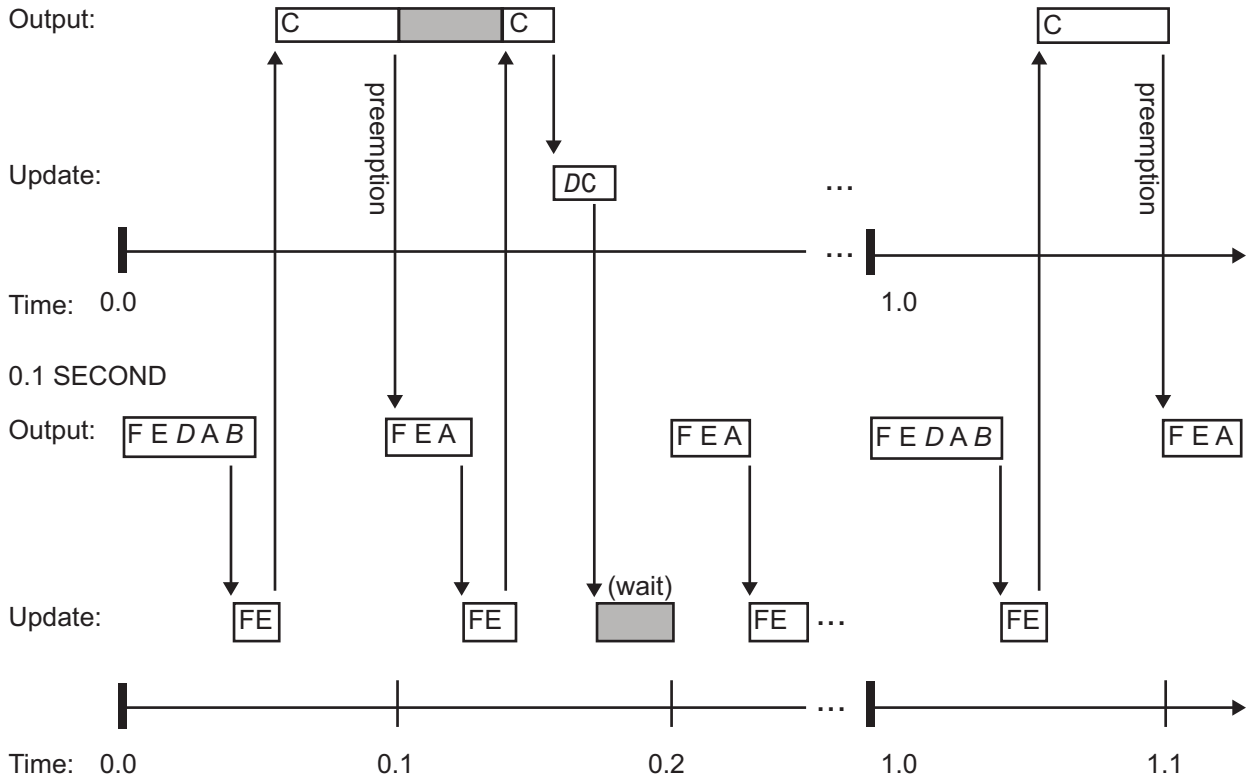

**Simulated Multitasking Execution.** The next figure shows the Simulink execution of the same model, in MultiTasking solver mode. In this case, the Simulink engine runs the blocks in one thread of execution, simulating multitasking. No preemption occurs.

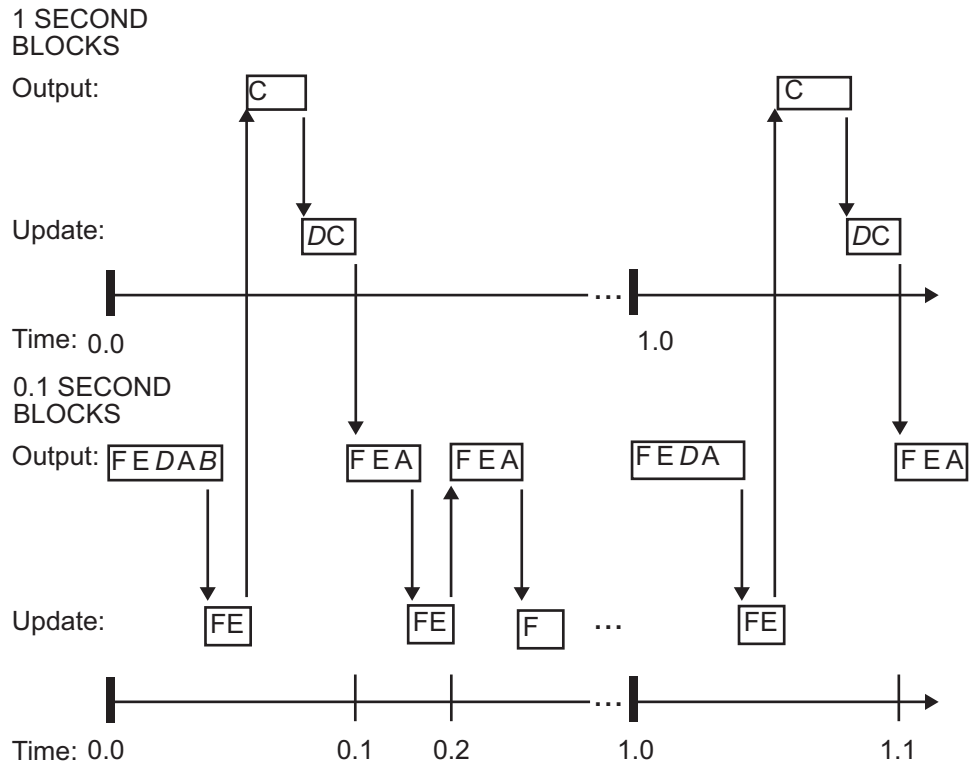

## Handle Asynchronous Events

- “About Asynchronous Events” on page 1-35
- “Handling Interrupts” on page 1-37
- “Rate Transitions and Asynchronous Blocks” on page 1-53
- “Use Timers in Asynchronous Tasks” on page 1-58
- “Create a Customized Asynchronous Library” on page 1-60
- “Import Asynchronous Event Data for Simulation” on page 1-69
- “Asynchronous Support Limitations” on page 1-74

## About Asynchronous Events

- “Asynchronous Support” on page 1-35
- “Block Library for Wind River Systems VxWorks Real-Time Operating System” on page 1-35
- “Access the VxWorks Block Library” on page 1-36
- “Generate Code with the VxWorks Library Blocks” on page 1-37
- “Examples and Additional Information” on page 1-37

**Asynchronous Support.** Simulink Coder models are normally timed from a *periodic* interrupt source (for example, a hardware timer). Blocks in a periodically clocked single-rate model run at a timer interrupt rate (the base rate of the model). Blocks in a periodically clocked multirate model run at the base rate or at submultiples of that rate.

Many systems must also support execution of blocks in response to events that are *asynchronous* with respect to the periodic timing source of the system. For example, a peripheral device might signal completion of an input operation by generating an interrupt. The system must service such interrupts, for example, by acquiring data from the interrupting device.

This chapter explains how to use blocks to model and generate code for asynchronous event handling, including servicing of hardware-generated interrupts, maintenance of timers, asynchronous read and write operations, and spawning of asynchronous tasks under a real-time operating system (RTOS). Although the blocks target the Wind River® Systems VxWorks® Tornado® RTOS, this chapter provides source code analysis and other information you can use to develop blocks that support asynchronous event handling for an alternative target RTOS.

**Block Library for Wind River Systems VxWorks Real-Time Operating System.** The next figure shows the blocks in the VxWorks block library (vxlib1).

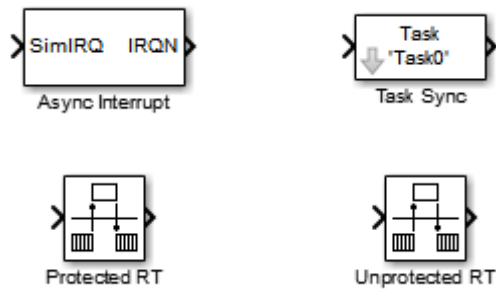

The key blocks in the library are the Async Interrupt and Task Sync blocks. These blocks are targeted for the VxWorks Tornado operating system. You can use them, without modification, to support VxWorks applications.

If you want to implement asynchronous support for an RTOS other than VxWorks RTOS, guidelines and example code are provided that will help you to adapt the VxWorks library blocks to target your RTOS. This topic is discussed in “Create a Customized Asynchronous Library” on page 1-60.

The VxWorks library includes blocks you can use to

- Generate interrupt-level code — Async Interrupt block
- Spawn a VxWorks task that calls a function call subsystem — Task Sync block
- Enable data integrity when transferring data between blocks running as different tasks — Protected RT block
- Use an unprotected/nondeterministic mode when transferring data between blocks running as different tasks — Unprotected RT block

The use of protected and unprotected Rate Transition blocks in asynchronous contexts is discussed in “Rate Transitions and Asynchronous Blocks” on page 1-53. For general information on rate transitions, see “Scheduling” on page 1-4.

**Access the VxWorks Block Library.** To access the VxWorks library, enter the MATLAB® command `vxlib1`.

**Generate Code with the VxWorks Library Blocks.** To generate a VxWorks compatible application from a model containing VxWorks library blocks, select one of the following targets from the System Target File Browser associated with the model:

- `ert.tlc` Embedded Coder. This target is provided with the Embedded Coder™ product.

When using the ERT target with VxWorks library blocks, you must select the **Generate an example main program** option, and select VxWorksExample from the **Target operating system** menu.

- `tornado.tlc` Tornado (VxWorks) Real-Time Target.

**Examples and Additional Information.** Additional information relevant to the topics in this chapter can be found in

- The `rtwdemo_async` model. To open this example, type `rtwdemo_async` at the MATLAB command prompt.
- The `rtwdemo_async_md1reftop` model. To open this example, type `rtwdemo_async_md1reftop` at the MATLAB command prompt.
- “Scheduling” on page 1-4, discusses general multitasking and rate transition issues for periodic models.
- The Embedded Coder documentation discusses the Embedded Real-Time (ERT) target, including task execution and scheduling.
- See your VxWorks system documentation for detailed information about the VxWorks system calls mentioned in this chapter.

## Handling Interrupts

- “Generate Interrupt Service Routines” on page 1-37
- “Spawn a Wind River Systems VxWorks Task” on page 1-46

**Generate Interrupt Service Routines.** To generate an interrupt service routine (ISR) associated with a specific Wind River Systems VxWorks VME interrupt level, use the Async Interrupt block. The Async Interrupt block enables the specified interrupt level and installs an ISR that calls a connected function call subsystem.

You can also use the Async Interrupt block in a simulation. It provides an input port that can be enabled and connected to a simulated interrupt source.

## Connecting the Async Interrupt Block

To generate an ISR, connect an output of the Async Interrupt block to the control input of

- A function call subsystem
- The input of a Task Sync block
- The input to a Stateflow chart configured for a function call input event

The next figure shows an Async Interrupt block configured to service two interrupt sources. The outputs (signal width 2) are connected to two function call subsystems.

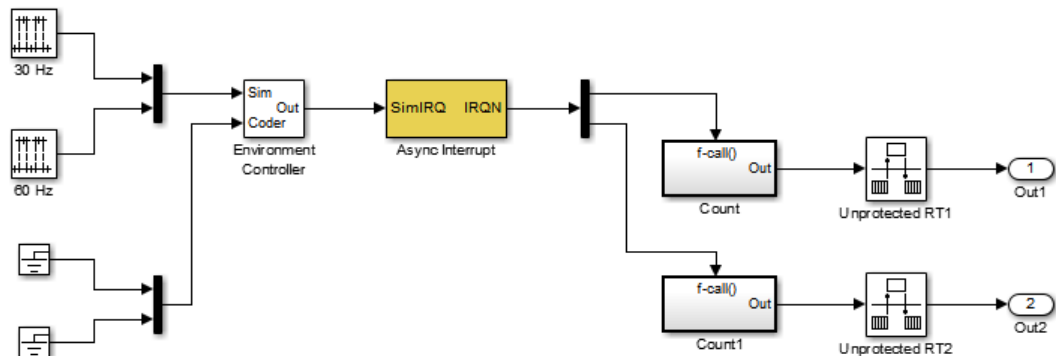

## Requirements and Restrictions

Note the following requirements and restrictions:

- The Async Interrupt block supports VME interrupts 1 through 7.

- The Async Interrupt block requires a VxWorks Board Support Package (BSP) that supports the following VxWorks system calls:
  - `sysIntEnable`
  - `sysIntDisable`
  - `intConnect`
  - `intLock`
  - `intUnlock`
  - `tickGet`

## Performance Considerations

Execution of large subsystems at interrupt level can have a significant impact on interrupt response time for interrupts of equal and lower priority in the system. As a general rule, it is best to keep ISRs as short as possible. Connect only function call subsystems that contain a small number of blocks to an Async Interrupt block.

A better solution for large subsystems is to use the Task Sync block to synchronize the execution of the function call subsystem to a VxWorks task. The Task Sync block is placed between the Async Interrupt block and the function call subsystem. The Async Interrupt block then installs the Task Sync block as the ISR. The ISR releases a synchronization semaphore (performs a `semGive`) to the task, and returns immediately from interrupt level. The task is then scheduled and run by the VxWorks RTOS. See “Spawn a Wind River Systems VxWorks Task” on page 1-46 for more information.

## Using the Async Interrupt Block in Simulation and Code Generation

This section describes a *dual-model* approach to the development and implementation of real-time systems that include ISRs. In this approach, you develop one model that includes a plant and a controller for simulation, and another model that only includes the controller for code generation. Using a Simulink library, you can implement changes to both models simultaneously. The next figure shows how changes made to the plant or controller, both of which are in a library, are propagated to the models.

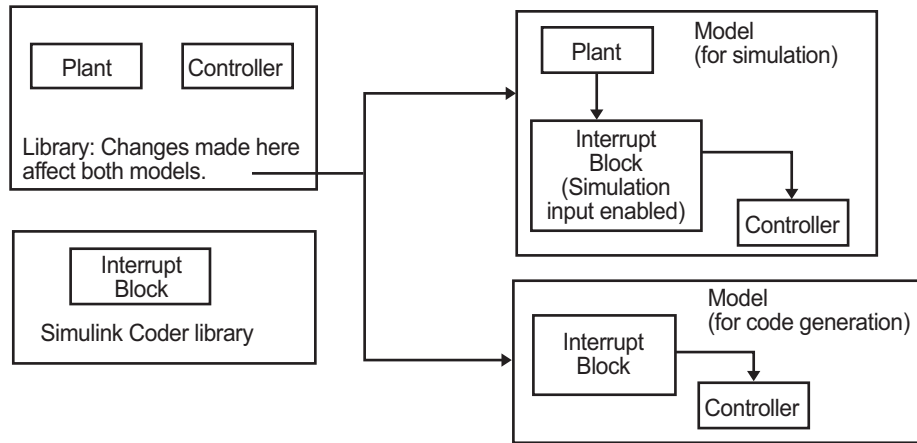

### Dual-Model Use of Async Interrupt Block for Simulation and Code Generation

A *single-model* approach is also possible. In this approach, the Plant component of the model is active only in simulation. During code generation, the Plant components are effectively switched out of the system and code is generated only for the interrupt block and controller parts of the model. For an example of this approach, see the `rtwdemo_async` model.

### Dual-Model Approach: Simulation

The following block diagram shows a simple model that illustrates the dual-model approach to modeling. During simulation, the Pulse Generator blocks provide simulated interrupt signals.



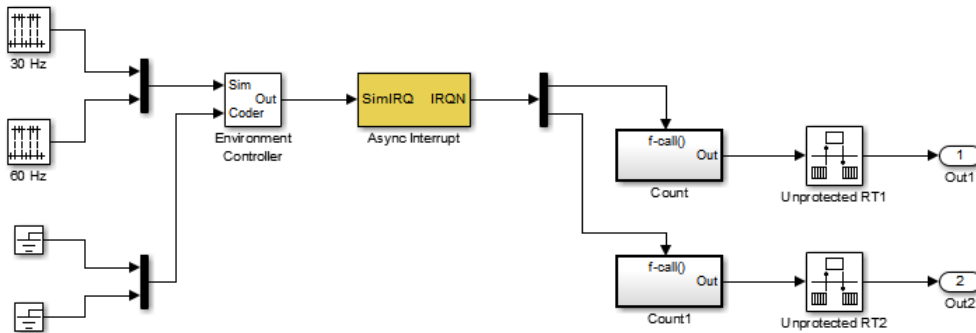

The simulated interrupt signals are routed through the Async Interrupt block's input port. Upon receiving a simulated interrupt, the block calls the connected subsystem.

During simulation, subsystems connected to Async Interrupt block outputs are executed in order of their VxWorks priority. In the event that two or more interrupt signals occur simultaneously, the Async Interrupt block executes the downstream systems in the order specified by their interrupt levels (level 7 gets the highest priority). The first input element maps to the first output element.

You can also use the Async Interrupt block in a simulation without enabling the simulation input. In such a case, the Async Interrupt block inherits the base rate of the model and calls the connected subsystems in order of their VxWorks priorities. (In effect, in this case the Async Interrupt block behaves as if all inputs received a 1 simultaneously.)

### Dual-Model Approach: Code Generation

In the generated code for the sample model,

- Ground blocks provide input signals to the Environment Controller block
- The Async Interrupt block does not use its simulation input

The Ground blocks drive control input of the Environment Controller block so no code is generated for that signal path. The Simulink Coder code generator does not generate code for blocks that drive the simulation control input to the Environment Controller block because that path is not selected during code generation. However, the sample times of driving blocks for the simulation input to the Environment Controller block contribute to the sample times supported in the generated code. To avoid including unnecessary sample times in the generated code, use the sample times of the blocks driving the simulation input in the model where generated code is intended.

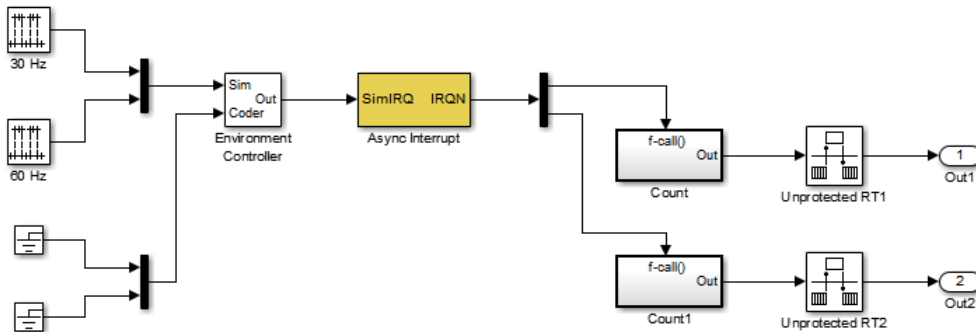

Standalone functions are installed as ISRs and the interrupt vector table is as follows:

### Offset

```
192    &isr_num1_vec192()
193    &isr_num2_vec193()
```

Consider the code generated from this model, assuming that the Async Interrupt block parameters are configured as shown in the next figure.

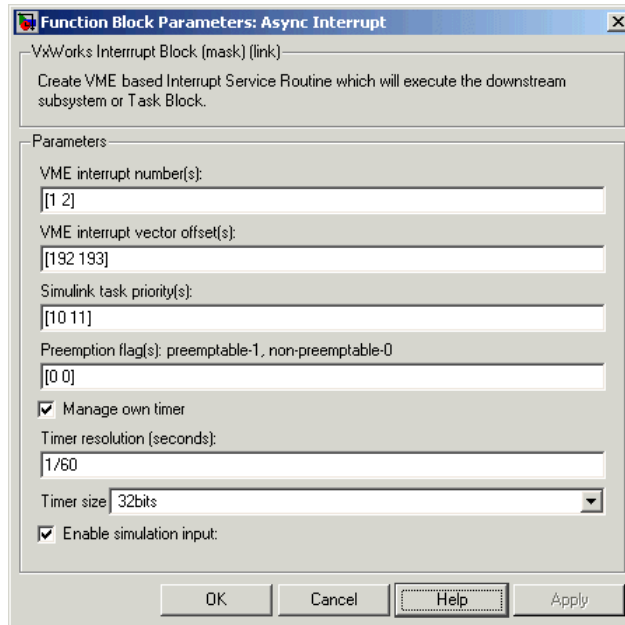

## Initialization Code

In the generated code, the Async Interrupt block installs the code in the Subsystem blocks as interrupt service routines. The interrupt vectors for IRQ1 and IRQ2 are stored at locations 192 and 193 relative to the base of the interrupt vector table, as specified by the **VME interrupt vector offset(s)** parameter.

Installing an ISR requires two VxWorks calls, `int_connect` and `sysInt_Enable`. The Async Interrupt block inserts these calls in the `model_initialize` function, as shown in the following code excerpt.

```
/* VxWorks Interrupt Block: '<Root>/Async Interrupt' */
/* Connect and enable ISR function: isr_num1_vec192 */
if( intConnect(INUM_TO_IVEC(192), isr_num1_vec192, 0) != OK) {
    printf("intConnect failed for ISR 1.\n");
}
sysIntEnable(1);
```

```
/* VxWorks Interrupt Block: '<Root>/Async Interrupt' */
/* Connect and enable ISR function: isr_num2_vec193 */
if( intConnect(INUM_TO_IVEC(193), isr_num2_vec193, 0) != OK)
{
    printf("intConnect failed for ISR 2.\n");
}
sysIntEnable(2);
```

The hardware that generates the interrupt is not configured by the Async Interrupt block. Typically, the interrupt source is a VME I/O board, which generates interrupts for specific events (for example, end of A/D conversion). The VME interrupt level and vector are set up in registers or by using jumpers on the board. You can use the `mdlStart` routine of a user-written device driver (S-function) to set up the registers and enable interrupt generation on the board. You must match the interrupt level and vector specified in the Async Interrupt block dialog to the level and vector set up on the I/O board.

## Generated ISR Code

The actual ISR generated for IRQ1 is listed below.

```
/* VxWorks Interrupt Block: '<Root>/Async Interrupt' */

void isr_num1_vec192(void)
{
    int_T lock;
    FP_CONTEXT context;

    /* Use tickGet() as a portable tick counter example.
       A much higher resolution can be achieved with a
       hardware counter */
    Async_Code_M->Timing.clockTick2 = tickGet();

    /* disable interrupts (system is configured as non-ive) */
    lock = intLock();

    /* save floating point context */
    fppSave(&context);
```

```

    /* Call the system: <Root>/Subsystem A */
    Count(0, 0);

    /* restore floating point context */
    fppRestore(&context);

    /* re-enable interrupts */
    intUnlock(lock);
}

```

There are several features of the ISR that should be noted:

- Because of the setting of the **Preemption Flag(s)** parameter, this ISR is locked; that is, it cannot be preempted by a higher priority interrupt. The ISR is locked and unlocked by the VxWorks `int_lock` and `int_unlock` functions.
- The connected subsystem, `Count`, is called from within the ISR.
- The `Count` function executes algorithmic (model) code. Therefore, the floating-point context is saved and restored across the call to `Count`.
- The ISR maintains its own absolute time counter, which is distinct from other periodic base rate or subrate counters in the system. Timing data is maintained for the use of any blocks executed within the ISR that require absolute or elapsed time.

See “Use Timers in Asynchronous Tasks” on page 1-58 for details.

## Model Termination Code

The model’s termination function disables the interrupts:

```

/* Model terminate function */
void Async_Code_terminate(void)
{
    /* VxWorks Interrupt Block: '<Root>/Async Interrupt' */
    /* Disable interrupt for ISR system: isr_num1_vec192 */
    sysIntDisable(1);
}

```

```
/* VxWorks Interrupt Block: '<Root>/Async Interrupt' */  
/* Disable interrupt for ISR system: isr_num2_vec193 */  
sysIntDisable(2);  
}
```

**Spawn a Wind River Systems VxWorks Task.** To spawn an independent VxWorks task, use the Task Sync block. The Task Sync block is a function call subsystem that spawns an independent VxWorks task. The task calls the function call subsystem connected to the output of the Task Sync block.

Typically, the Task Sync block is placed between an Async Interrupt block and a function call subsystem block or a Stateflow chart. Another example would be to place the Task Sync block at the output of a Stateflow chart that has an event, `Output to Simulink`, configured as a function call.

The Task Sync block performs the following functions:

- An independent task is spawned, using the VxWorks system call `taskSpawn`. When the task is activated, it calls the downstream function call subsystem code. The task is deleted using `taskDelete` during model termination.
- A semaphore is created to synchronize the connected subsystem to the execution of the Task Sync block.
- The spawned task is wrapped in an infinite `for` loop. In the loop, the spawned task listens for the semaphore, using `semTake`. When `semTake` is first called, `NO_WAIT` is specified. This allows the task to determine whether a second `semGive` has occurred prior to the completion of the function call subsystem. This would indicate that the interrupt rate is too fast or the task priority is too low.
- The Task Sync block generates synchronization code (for example, `semGive()`). This code allows the spawned task to run; the task in turn calls the connected function call subsystem code. The synchronization code can run at interrupt level. This is accomplished by connecting the Task Sync block to the output of an Async Interrupt block, which triggers execution of the Task Sync block within an ISR.
- If blocks in the downstream algorithmic code require absolute time, it can be supplied either by the timer maintained by the Async Interrupt block,

or by an independent timer maintained by the task associated with the Task Sync block.

For an example of how to use the Task Sync block, see the `rtwdemo_async` example. The block diagram for the model appears in the next figure. Before reading the following discussion, open the example model and double-click the **Generate Code** button. You can then examine the generated code in the HTML code generation report produced by the example.

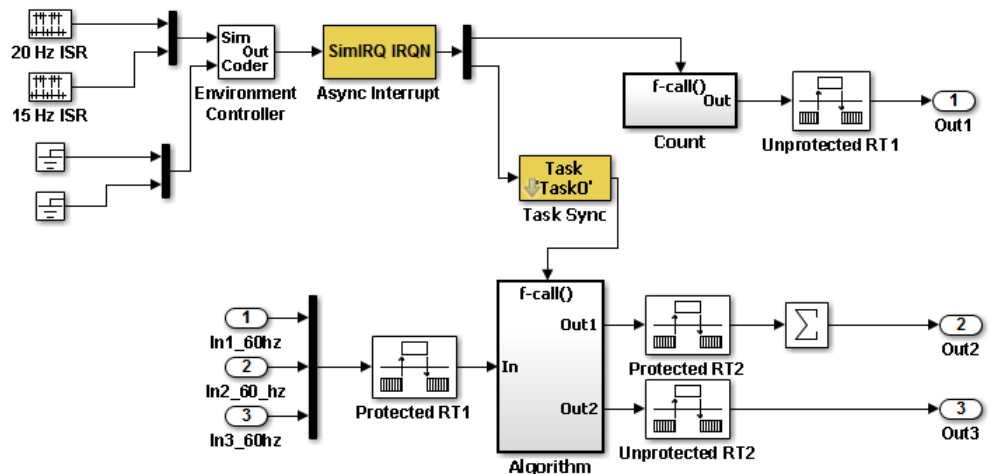

In this model, the Async Interrupt block is configured for VME interrupts 1 and 2, using interrupt vector offsets 192 and 193. Interrupt 2 is connected to the Task Sync block, which in turn drives the Algorithm subsystem. Consider the code generated from this model, assuming that the Task Sync block parameters are configured as shown in the next figure.

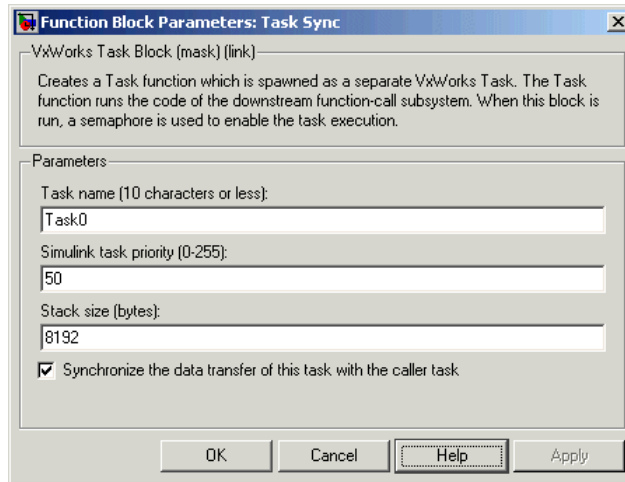

## Initialization Code

The Task Sync block generates initialization code for initialization by `MdlStart`, which itself creates and initializes the synchronization semaphore. It also spawns an independent task (`task0`).

```

/* VxWorks Task Block: <S5>/S-Function (vxtask1) */
/* Spawn task: Task0 with priority 50 */
if ((*SEM_ID *)rtwdemo_async_DWork.SFunction_PWORK.SemID =
    semBCreate(SEM_Q_PRIORITY, SEM_EMPTY)) == NULL) {
    printf("semBCreate call failed for block Task0.\n");
}
if ((rtwdemo_async_DWork.SFunction_IWORK.TaskID = taskSpawn("Task0",
    50.0, VX_FP_TASK, 8192.0, (FUNCPTR)Task0, 0, 0, 0, 0, 0, 0,
    0, 0, 0)) == ERROR) {
    printf("taskSpawn call failed for block Task0.\n");
}

```

After spawning `Task0`, `MdlStart` connects and enables the ISR (`isr_num2_vec193`) for interrupt 2:

```

/* VxWorks Interrupt Block: '<Root>/Async Interrupt' */
/* Connect and enable ISR function: isr_num1_vec192 */

```



```

if( intConnect(INUM_TO_IVEC(192), isr_num1_vec192, 0) != 0K) {
    printf("intConnect failed for ISR 1.\n");
}
sysIntEnable(1);

```

The ordering of these operations is significant. The task must be spawned before the interrupt that activates it can be enabled.

## Task and Task Synchronization Code

The function `Task0`, generated by the Task Sync block, runs as a VxWorks task. The task waits for a synchronization semaphore in an infinite `for` loop. If it obtains the semaphore, it updates its task timer and calls the Algorithm subsystem.

For this example, the **Synchronize the data transfer of this task with the caller task** option of the Task Sync block is selected. Therefore, the timer associated with the Task Sync block (`rtM->Timing.clockTick2`) is updated with the value of the timer that is maintained by the Async Interrupt block (`rtM->Timing.clockTick3`). Therefore, blocks within the Algorithm subsystem use timer values based on the time of the most recent interrupt (not the most recent activation of `Task0`).

```

/* VxWorks Task Block: <S5>/S-Function (vxtask1) */
/* Spawned with priority: 50 */
void Task0(void)
{
    /* Wait for semaphore to be released by system:
       rtwdemo_async/Task Sync */
    for(;;) {
        if (semTake(*(SEM_ID
            *)rtwdemo_async_DWork.SFunction_PWORK.SemID,NO_WAIT) !=
            ERROR) {
            logMsg("Rate for Task Task0() too fast.\n",0,0,0,0,0);
        }
    }
    #if STOPONOVERRUN
        logMsg("Aborting real-time simulation.\n",0,0,0,0,0);
        semGive(stopSem);
        return(ERROR);
    #endif
}

```

```
    } else {
        semTake(*(SEM_ID
            *)rtwdemo_async_DWork.SFunction_PWORK.SemID,
            WAIT_FOREVER);
    }
    /* Use the upstream clock tick counter for this Task. */
    rtwdemo_async_M->Timing.clockTick2 =
    rtwdemo_async_M->Timing.clockTick3;

    /* Call the system: <Root>/Algorithm */
{

    /* Output and update for function-call system: '<Root>/Algorithm' */

    {

        uint32_T rt_currentTime = ((uint32_T)rtwdemo_async_M->Timing.clockTick2);
        uint32_T rt_elapseTime = rt_currentTime -
            rtwdemo_async_DWork.Algorithm_PREV_T;
        rtwdemo_async_DWork.Algorithm_PREV_T = rt_currentTime;

        {

            int32_T i;

            /* DiscreteIntegrator: '<S1>/Integrator' */
            rtwdemo_async_B.Integrator = rtwdemo_async_DWork.Integrator_DSTATE;
            for(i = 0; i < 60; i++) {

                /* Sum: '<S1>/Sum' */
                rtwdemo_async_B.Sum[i] = rtwdemo_async_B.ProtectedRT1[i] + 1.25;
            }
        }

        /* Sum: '<S1>/Sum1' */
        rtwdemo_async_B.Sum1 = rtwdemo_async_B.Sum[0];
        {

            int_T i1;

            const real_T *u0 = &rtwdemo_async_B.Sum[1];
```

```

    for (i1=0; i1 < 59; i1++) {
        rtwdemo_async_B.Sum1 += u0[i1];
    }
}

{
    int32_T i;
    if(rtwdemo_async_DWork.ProtectedRT2_ActiveBufIdx) {
        for(i = 0; i < 60; i++) {
            rtwdemo_async_DWork.ProtectedRT2_Buffer0[i] =
                rtwdemo_async_B.Sum[i];
        }
        rtwdemo_async_DWork.ProtectedRT2_ActiveBufIdx = (boolean_T)0U;
    } else {
        for(i = 0; i < 60; i++) {
            rtwdemo_async_DWork.ProtectedRT2_Buffer1[i] =
                rtwdemo_async_B.Sum[i];
        }
        rtwdemo_async_DWork.ProtectedRT2_ActiveBufIdx = (boolean_T)1U;
    }
}

/* Update for DiscreteIntegrator: '<S1>/Integrator' */
rtwdemo_async_DWork.Integrator_DSTATE = (real_T)rt_elapsedTime *
    1.6666666666666666E-002 * rtwdemo_async_B.Sum1 +
    rtwdemo_async_DWork.Integrator_DSTATE;
}

```

The semaphore is granted by the function `isr_num2_vec193`, which is called from interrupt level:

```

/* VxWorks Interrupt Block: '<Root>/Async Interrupt' */
void isr_num2_vec193(void)
{

    /* Use tickGet() as a portable tick counter example. A much
       higher resolution can be achieved with a hardware counter */
    rtwdemo_async_M->Timing.clockTick3 = tickGet();

    /* Call the system: <S4>/Subsystem */

```

```
/* Output and update for function-call system:
   '<S4>/Subsystem' */
{
    {
        int32_T i;
        for(i = 0; i < 60; i++) {
            if(rtwdemo_async_DWork.ProtectedRT1_ActiveBufIdx) {
                rtwdemo_async_B.ProtectedRT1[i] =
                    rtwdemo_async_DWork.ProtectedRT1_Buffer1[i];
            } else {
                rtwdemo_async_B.ProtectedRT1[i] =
                    rtwdemo_async_DWork.ProtectedRT1_Buffer0[i];
            }
        }
    }
}

/* VxWorks Task Block: <S5>/S-Function (vxtask1) */
/* Release semaphore for system task: Task0 */
semGive(*(SEM_ID *)rtwdemo_async_DWork.SFunction_PWORK.SemID);
}
}
```

The ISR maintains a timer that stores the tick count at the time of interrupt. This timer is updated before releasing the semaphore that activates Task0.

As this example shows, the Task Sync block generates only a small amount of interrupt-level code.

## Task Termination Code

The Task Sync block also generates the following termination code.

```
/* Model terminate function */

void rtwdemo_async_terminate(void)
{
```

```

/* VxWorks Interrupt Block: '<Root>/Async Interrupt' */
/* Disable interrupt for ISR system: isr_num1_vec192 */
sysIntDisable(1);

/* VxWorks Interrupt Block: '<Root>/Async Interrupt' */
/* Disable interrupt for ISR system: isr_num2_vec193 */
sysIntDisable(2);

/* Terminate for function-call system: '<S4>/Subsystem' */
/* VxWorks Task Block: <S5>/S-Function (vxtask1) */
/* Destroy task: Task0 */
taskDelete(rtwdemo_async_DWork.SFunction_IWORK.TaskID);
}

```

## Rate Transitions and Asynchronous Blocks

- “About Rate Transitions and Asynchronous Blocks” on page 1-53
- “Handle Rate Transitions for Asynchronous Tasks” on page 1-55
- “Handle Multiple Asynchronous Interrupts” on page 1-56

**About Rate Transitions and Asynchronous Blocks.** Because an asynchronous function call subsystem can preempt or be preempted by other model code, an inconsistency arises when more than one signal element is connected to an asynchronous block. The issue is that signals passed to and from the function call subsystem can be in the process of being written to or read from when the preemption occurs. Thus, some old and some new data is used. This situation can also occur with scalar signals in some cases. For example, if a signal is a double (8 bytes), the read or write operation might require two machine instructions.

The Simulink Rate Transition block is designed to deal with preemption problems that occur in data transfer between blocks running at different rates. These issues are discussed in “Scheduling” on page 1-4.

You can handle rate transition issues automatically by selecting the **Automatically handle data transfers between tasks** option on the **Solver** pane of the Configuration Parameters dialog box. This saves you from having to manually insert Rate Transition blocks to avoid invalid rate transitions,

including invalid *asynchronous-to-periodic* and *asynchronous-to-asynchronous* rate transitions, in multirate models. For asynchronous tasks, the Simulink engine configures inserted blocks for data integrity but not determinism during data transfers.

For asynchronous rate transitions, the Rate Transition block provides data integrity, but cannot provide determinism. Therefore, when you insert Rate Transition blocks explicitly, you must clear the **Ensure data determinism** check box in the Block Parameters dialog box.

When you insert a Rate Transition block between two blocks to maintain data integrity and priorities are assigned to the tasks associated with the blocks, the Simulink Coder software assumes that the higher priority task can preempt the lower priority task and the lower priority task cannot preempt the higher priority task. If the priority associated with task for either block is not assigned or the priorities of the tasks for both blocks are the same, the Simulink Coder software assumes that either task can preempt the other task.

Priorities of periodic tasks are assigned by the Simulink engine, in accordance with the options specified in the **Solver options** section of the **Solver** pane of the Configuration Parameters dialog box. When the **Periodic sample time constraint** option field of **Solver options** is set to Unconstrained, the model base rate priority is set to 40. Priorities for subrates then increment or decrement by 1 from the base rate priority, depending on the setting of the **Higher priority value indicates higher task priority option**.

You can assign priorities manually by using the **Periodic sample time properties** field. The Simulink engine does not assign a priority to asynchronous blocks. For example, the priority of a function call subsystem that connects back to an Async Interrupt block is assigned by the Async Interrupt block.

The **Simulink task priority** field of the Async Interrupt block specifies a priority level (required) for every interrupt number entered in the **VME interrupt number(s)** field. The priority array sets the priorities of the subsystems connected to each interrupt.

For the Task Sync block, if the Wind River Systems VxWorks RTOS is the target, the **Higher priority value indicates higher task priority option** should be deselected. The **Simulink task priority** field specifies the block

priority relative to connected blocks (in addition to assigning a VxWorks priority to the generated task code).

The VxWorks library provides two types of rate transition blocks as a convenience. These are simply preconfigured instances of the built-in Simulink Rate Transition block:

- Protected Rate Transition block: Rate Transition block that is configured with the **Ensure data integrity during data transfers** on and **Ensure deterministic data transfer** off.
- Unprotected Rate Transition block: Rate Transition block that is configured with the **Ensure data integrity during data transfers** option off.

**Handle Rate Transitions for Asynchronous Tasks.** For rate transitions that involve asynchronous tasks, you can maintain data integrity. However, you cannot achieve determinism. You have the option of using the Rate Transition block or target-specific rate transition blocks.

Consider the following model, which includes a Rate Transition block.

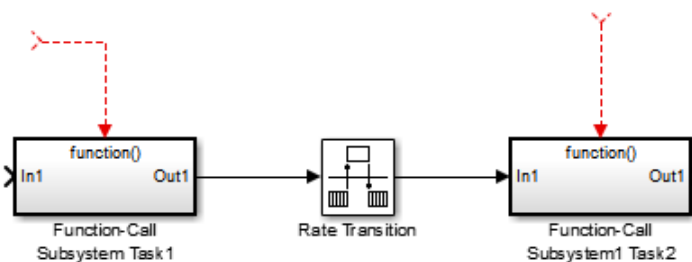

You can use the Rate Transition block in either of the following modes:

- Maintain data integrity, no determinism
- Unprotected

Alternatively, you can use target-specific rate transition blocks. The following blocks are available for the VxWorks RTOS:

- Protected Rate Transition block (reader)
- Protected Rate Transition block (writer)
- Unprotected Rate Transition block

**Handle Multiple Asynchronous Interrupts.** Consider the following model, in which two functions trigger the same subsystem.

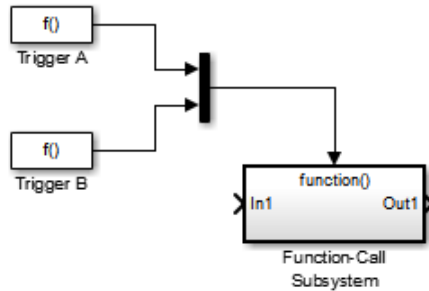

The two tasks must have equal priorities. When priorities are the same, the outcome depends on whether they are firing periodically or asynchronously, and also on a diagnostic setting. The following table and notes describe these outcomes:

**Supported Sample Time and Priority for Function Call Subsystem with Multiple Triggers**

	<b>Async Priority = 1</b>	<b>Async Priority = 2</b>	<b>Async Priority Unspecified</b>	<b>Periodic Priority = 1</b>	<b>Periodic Priority = 2</b>
<b>Async Priority = 1</b>	Supported (1)				
<b>Async Priority = 2</b>		Supported (1)			
<b>Async Priority Unspecified</b>			Supported (2)		



## Supported Sample Time and Priority for Function Call Subsystem with Multiple Triggers (Continued)

	Async Priority = 1	Async Priority = 2	Async Priority Unspecified	Periodic Priority = 1	Periodic Priority = 2
Periodic Priority = 1				Supported	
Periodic Priority = 2					Supported

**1** Control these outcomes using the **Tasks with equal priority** option in the **Diagnostics** pane of the Configuration Parameters dialog box; set this diagnostic to none if tasks of equal priority cannot preempt each other in the target system.

**2** For this case, the following warning message is issued unconditionally:

```
The function call subsystem <name> has multiple asynchronous
triggers that do not specify priority. Data integrity will
not be maintained if these triggers can preempt one another.
```

Empty cells in the above table represent multiple triggers with differing priorities, which are unsupported.

The Simulink Coder product provides absolute time management for a function call subsystem connected to multiple interrupts in the case where timer settings for TriggerA and TriggerB (time source, resolution) are the same.

Assume that all of the following conditions are true for the model shown above:

- A function call subsystem is triggered by two asynchronous triggers (TriggerA and TriggerB) having identical priority settings.
- Each trigger sets the source of time and timer attributes by calling the functions `ssSetTimeSource` and `ssSetAsyncTimerAttributes`.

- The triggered subsystem contains a block that needs elapsed or absolute time (for example, a Discrete Time Integrator).

The asynchronous function call subsystem has one global variable, `clockTick#` (where # is the task ID associated with the subsystem). This variable stores absolute time for the asynchronous task. There are two ways timing can be handled:

- If the time source is set to `SS_TIMESOURCE_BASERATE`, the Simulink Coder code generator generates timer code in the function call subsystem, updating the clock tick variable from the base rate clock tick. Data integrity is maintained if the same priority is assigned to `TriggerA` and `TriggerB`.
- If the time source is `SS_TIMESOURCE_SELF`, generated code for both `TriggerA` and `TriggerB` updates the same clock tick variable from the hardware clock.

The word size of the clock tick variable can be set directly or be established according to the **Application lifespan (days)** setting and the timer resolution set by the `TriggerA` and `TriggerB` S-functions (which must be the same). See “Use Timers in Asynchronous Tasks” on page 1-58 and “Control Memory Allocation for Time Counters” on page 16-9 for more information.

## Use Timers in Asynchronous Tasks

An ISR can set a source for absolute time. This is done with the function `ssSetTimeSource`, which has the following three options:

- `SS_TIMESOURCE_SELF`: Each generated ISR maintains its own absolute time counter, which is distinct from any periodic base rate or substrate counters in the system. The counter value and the timer resolution value (specified in the **Timer resolution (seconds)** parameter of the Async Interrupt block) are used by downstream blocks to determine absolute time values required by block computations.
- `SS_TIMESOURCE_CALLER`: The ISR reads time from a counter maintained by its caller. Time resolution is thus the same as its caller’s resolution.
- `SS_TIMESOURCE_BASERATE`: The ISR can read absolute time from the model’s periodic base rate. Time resolution is thus the same as its base rate resolution.

---

**Note** The function `ssSetTimeSource` cannot be called before `ssSetOutputPortWidth` is called. If this occurs, the program will come to a halt and generate an error message.

---

By default, the counter is implemented as a 32-bit unsigned integer member of the `Timing` substructure of the real-time model structure. For any target that supports the `rtModel` data structure, when the time data type is not set by using `ssSetAsyncTimeDataType`, the counter word size is determined by the **Application lifespan (days)** model parameter. As an example (from ERT target code),

```
/* Real-time Model Data Structure */
struct _RT_MODEL_elapseTime_exp_Tag {
    const char *errorStatus;

    /*
     * Timing:
     * The following substructure contains information regarding
     * the timing information for the model.
     */
    struct {
        uint32_T clockTick1;
        uint32_T clockTick2;
    } Timing;
};
```

The example omits unused fields in the `Timing` data structure (a feature of ERT target code not found in GRT). For any target that supports the `rtModel` data structure, the counter word size is determined by the **Application lifespan (days)** model parameter.

By default, the library blocks for the Wind River Systems VxWorks RTOS set the timer source to `SS_TIMESOURCE_SELF` and update their counters by using the system call `tickGet`. `tickGet` returns a timer value maintained by the VxWorks kernel. The maximum word size for the timer is `UINT32`. The following VxWorks example for the shows a generated call to `tickGet`.

```
/* VxWorks Interrupt Block: '<Root>/Async Interrupt' */
void isr_num2_vec193(void)
```

```
{  
  
    /* Use tickGet() as a portable tick counter example. A much  
       higher resolution can be achieved with a hardware counter */  
    rtM->Timing.clockTick2 = tickGet();  
    . . .
```

The `tickGet` call is supplied only as an example. It can (and in many instances should) be replaced by a timing source that has better resolution. If you are targeting the VxWorks RTOS, you can obtain better timer resolution by replacing the `tickGet` call and accessing a hardware timer by using your BSP instead.

If you are implementing a custom asynchronous block for an RTOS other than the VxWorks RTOS, you should either generate an equivalent call to the target RTOS, or generate code to read a timer register on the target hardware.

The default **Timer resolution (seconds)** parameter of your Async Interrupt block implementation should be changed to match the resolution of your target's timing source.

The counter is updated at interrupt level. Its value represents the tick value of the timing source at the most recent execution of the ISR. The rate of this timing source is unrelated to sample rates in the model. In fact, typically it is faster than the model's base rate. Select the timer source and set its rate and resolution based on the expected rate of interrupts to be serviced by the Async Interrupt block.

For an example of timer code generation, see “Async Interrupt Block Implementation” on page 1-61.

## **Create a Customized Asynchronous Library**

- “About Implementing Asynchronous Blocks” on page 1-61
- “Async Interrupt Block Implementation” on page 1-61
- “Task Sync Block Implementation” on page 1-66
- “asynclib.tlc Support Library” on page 1-68

**About Implementing Asynchronous Blocks.** This section describes how to implement asynchronous blocks for use with your target RTOS, using the Async Interrupt and Task Sync blocks as a starting point. (Rate Transition blocks are target-independent, so you do not need to develop customized rate transition blocks.)

You can customize the asynchronous library blocks by modifying the block implementation. These files are

- The block's underlying S-function MEX-file
- The TLC files that control code generation of the block

In addition, you need to modify the block masks to remove references specific to the Wind River Systems VxWorks RTOS and to incorporate parameters required by your target RTOS.

Custom block implementation is an advanced topic, requiring familiarity with the Simulink MEX S-function format and API, and with the Target Language Compiler (TLC). These topics are covered in the following documents:

- Simulink topics “What Is an S-Function?”, “Use S-Functions in Models”, “How S-Functions Work”, and “Implementing S-Functions” describe MEX S-functions and the S-function API in general.
- The “Inlining S-Functions”, “Inlining C MEX S-Functions”, and “Insert S-Function Code” on page 14-46 describe how to create a TLC block implementation for use in code generation.

The following sections discuss the C/C++ and TLC implementations of the asynchronous library blocks, including required `SimStruct` macros and functions in the TLC asynchronous support library (`asynclib.tlc`).

**Async Interrupt Block Implementation.** The source files for the Async Interrupt block are located in `matlabroot/rtw/c/tornado/devices`:

- `vxinterrupt1.c`: C MEX-file source code, for use in configuration and simulation
- `vxinterrupt1.tlc`: TLC implementation, for use in code generation

- `asynclib.tlc`: library of TLC support functions, called by the TLC implementation of the block. The library calls are summarized in “asynclib.tlc Support Library” on page 1-68.

## C MEX Block Implementation

Most of the code in `vxinterrupt1.c` performs ordinary functions that are not related to asynchronous support (for example, obtaining and validating parameters from the block mask, marking parameters nontunable, and passing parameter data to the `model.rtw` file).

The `mdlInitializeSizes` function uses special `SimStruct` macros and `SS_OPTIONS` settings that are required for asynchronous blocks, as described below.

Note that the following macros cannot be called before `ssSetOutputPortWidth` is called:

- `ssSetTimeSource`
- `ssSetAsyncTimerAttributes`
- `ssSetAsyncTimerResolutionEl`
- `ssSetAsyncTimerDataType`
- `ssSetAsyncTimerDataTypeEl`
- `ssSetAsyncTaskPriorities`
- `ssSetAsyncTaskPrioritiesEl`

If any one of the above macros is called before `ssSetOutputPortWidth`, the following error message will appear:

```
SL_SfcnMustSpecifyPortWidthBfCallSomeMacro {
S-function '%s' in '%<BLOCKFULLPATH>'
must set output port %d width using
ssSetOutputPortWidth before calling macro %s
}
```

## ssSetAsyncTimerAttributes

`ssSetAsyncTimerAttributes` declares that the block requires a timer, and sets the resolution of the timer as specified in the **Timer resolution (seconds)** parameter.

The function prototype is

```
ssSetAsyncTimerAttributes(SimStruct *S, double res)
```

where

- S is a Simstruct pointer.
- res is the **Timer resolution (seconds)** parameter value.

The following code excerpt shows the call to `ssSetAsyncTimerAttributes`.

```
/* Setup Async Timer attributes */  
ssSetAsyncTimerAttributes(S,mxGetPr(TICK_RES)[0]);
```

## ssSetAsyncTaskPriorities

`ssSetAsyncTaskPriorities` sets the Simulink task priority for blocks executing at each interrupt level, as specified in the block's **Simulink task priority** field.

The function prototype is

```
ssSetAsyncTaskPriorities(SimStruct *S, int numISRs,  
                          int *priorityArray)
```

where

- S is a SimStruct pointer.
- numISRs is the number of interrupts specified in the **VME interrupt number(s)** parameter.
- priorityarray is an integer array containing the interrupt numbers specified in the **VME interrupt number(s)** parameter.

The following code excerpt shows the call to `ssSetAsyncTaskPriorities`:

```
/* Setup Async Task Priorities */
priorityArray = malloc(numISRs*sizeof(int_T));
for (i=0; i<numISRs; i++) {
    priorityArray[i] = (int_T)(mxGetPr(ISR_PRIORITIES)[i]);
}
ssSetAsyncTaskPriorities(S, numISRs, priorityArray);
free(priorityArray);
priorityArray = NULL;
}
```

## SS\_OPTION Settings

The code excerpt below shows the `SS_OPTION` settings for `vxinterrupt1.c`. `SS_OPTION_ASYNCHRONOUS_INTERRUPT` should be used when a function call subsystem is attached to an interrupt. For more information, see the documentation for `SS_OPTION` and `SS_OPTION_ASYNCHRONOUS` in `matlabroot/simulink/include/simstruc.h`.

```
ssSetOptions( S, (SS_OPTION_EXCEPTION_FREE_CODE |
                 SS_OPTION_DISALLOW_CONSTANT_SAMPLE_TIME |
                 SS_OPTION_ASYNCHRONOUS_INTERRUPT |
```

## TLC Implementation

This section discusses each function of `vxinterrupt1.tlc`, with an emphasis on target-specific features that you will need to change to generate code for your target RTOS.

## Generate #include Directives

`vxinterrupt1.tlc` begins with the statement

```
%include "vxlib.tlc"
```

`vxlib.tlc` is a target-specific file that generates directives to include VxWorks header files. You should replace this with a file that generates includes for your target RTOS.



## BlockInstanceSetup Function

For each connected output of the Async Interrupt block, `BlockInstanceSetup` defines a function name for the corresponding ISR in the generated code. The functions names are of the form

*isr\_num\_vec\_offset*

where *num* is the ISR number defined in the **VME interrupt number(s)** block parameter, and *offset* is an interrupt table offset defined in the **VME interrupt vector offset(s)** block parameter.

In a custom implementation, there is no requirement to use this naming convention.

The function names are cached for use by the `Outputs` function, which generates the actual ISR code.

## Outputs Function

`Outputs` iterates over the connected outputs of the Async Interrupt block. An ISR is generated for each such output.

The ISR code is cached in the "Functions" section of the generated code. Before generating the ISR, `Outputs` does the following:

- Generates a call to the downstream block (cached in a temporary buffer).
- Determines whether the ISR should be locked or not (as specified in the **Preemption Flag(s)** block parameter).
- Determines whether the block connected to the Async Interrupt block is a Task Sync block. (This information is obtained by using the `asynclib` calls `LibGetFcnCallBlock` and `LibGetBlockAttribute`.) If so,
  - The preemption flag for the ISR must be set to 1. An error results otherwise.
  - `VxWorks` calls to save and restore floating-point context are generated, unless the user has configured the model for integer-only code generation.

When generating the ISR code, `Outputs` calls the `asynclib` function `LibNeedAsyncCounter` to determine whether a timer is required by the connected subsystem. If so, and if the time source is set to be `SS_TIMESOURCE_SELF` by `ssSetTimeSource`, `LibSetAsyncCounter` is called to generate a VxWorks `tickGet` function call and update the counter. In your implementation, you should generate either an equivalent call to the target RTOS, or generate code to read the a timer register on the target hardware.

If you are targeting the VxWorks RTOS, you can obtain better timer resolution by replacing the `tickGet` call and accessing a hardware timer by using your BSP instead. `tickGet` supports only a 1/60 second resolution.

## Start Function

The `Start` function generates the required VxWorks calls (`int_connect` and `sysInt_Enable`) to connect and enable each ISR. You should replace this with calls to your target RTOS.

## Terminate Function

The `Terminate` function generates the call `sysIntDisable` to disable each ISR. You should replace this with calls to your target RTOS.

**Task Sync Block Implementation.** The source files for the Task Sync block are located in `matlabroot/rtw/c/tornado/devices`. They are

- `vxtask1.c`: MEX-file source code, for use in configuration and simulation.
- `vxtask1.tlc`: TLC implementation, for use in code generation.
- `asynclib.tlc`: library of TLC support functions, called by the TLC implementation of the block. The library calls are summarized in “`asynclib.tlc` Support Library” on page 1-68.

## C MEX Block Implementation

Like the Async Interrupt block, the Task Sync block sets up a timer, in this case with a fixed resolution. The priority of the task associated with the block

is obtained from the **Simulink task priority** parameter. The `SS_OPTION` settings are the same as those used for the Async Interrupt block.

```
ssSetAsyncTimerAttributes(S, 0.01);

priority = (int_T) (*(mxGetPr(PRIORITY)));
ssSetAsyncTaskPriorities(S,1,&priority);

ssSetOptions(S, (SS_OPTION_EXCEPTION_FREE_CODE |
                SS_OPTION_ASYNCHRONOUS |
                SS_OPTION_DISALLOW_CONSTANT_SAMPLE_TIME |
                }

```

TLC Implementation

## Generate #include Directives

`vxtask1.tlc` begins with the statement

```
%include "vxlib.tlc"
```

`vxlib.tlc` is a target-specific file that generates directives to include VxWorks header files. You should replace this with a file that generates includes for your target RTOS.

## BlockInstanceSetup Function

The `BlockInstanceSetup` function derives the task name, block name, and other identifier strings used later in code generation. It also checks for and warns about unconnected block conditions, and generates a storage declaration for a semaphore (`stopSem`) that is used in case of interrupt overflow conditions.

## Start Function

The `Start` function generates the required VxWorks calls to define storage for the semaphore that is used in management of the task spawned by the

Task Sync block. Depending on the code format of the target, either a static storage declaration or a dynamic memory allocation call is generated. This function also creates a semaphore (`semBCreate`) and spawns a VxWorks task (`taskSpawn`). You should replace these with calls to your target RTOS.

## Outputs Function

The `Outputs` function generates a VxWorks task that waits for a semaphore. When it obtains the semaphore, it updates the block's tick timer and calls the downstream subsystem code, as described in "Spawn a Wind River Systems VxWorks Task" on page 1-46. `Outputs` also generates code (called from interrupt level) that grants the semaphore.

## Terminate Function

The `Terminate` function generates the VxWorks call `taskDelete` to end execution of the task spawned by the block. You should replace this with calls to your target RTOS.

Note also that if the target RTOS has dynamically allocated any memory associated with the task, the `Terminate` function should deallocate the memory.

**asynclib.tlc Support Library.** `asynclib.tlc` is a library of TLC functions that support the implementation of asynchronous blocks. Some functions are specifically designed for use in asynchronous blocks. For example, `LibSetAsyncCounter` generates a call to update a timer for an asynchronous block. Other functions are utilities that return information required by asynchronous blocks (for example, information about connected function call subsystems).

The following table summarizes the public calls in the library. For details, see the library source code and the `vxinterrupt1.tlc` and `vxtask1.tlc` files, which call the library functions.

## Summary of `asynclib.tlc` Library Functions

Function	Description
<code>LibBlockExecuteFcnCall</code>	For use by inlined S-functions with function call outputs. Generates code to execute a function call subsystem.
<code>LibGetBlockAttribute</code>	Returns a field value from a block record.
<code>LibGetFcnCallBlock</code>	Given an S-Function block and call index, returns the block record for the downstream function call subsystem block.
<code>LibGetCallerClockTickCounter</code>	Provides access to the time counter of an upstream asynchronous task.
<code>LibGetCallerClockTickCounterHighWord</code>	Provides access to the high word of the time counter of an upstream asynchronous task.
<code>LibManageAsyncCounter</code>	Determines whether an asynchronous task needs a counter and manages its own timer.
<code>LibNeedAsyncCounter</code>	If the calling block requires an asynchronous counter, returns <code>TLC_TRUE</code> , otherwise returns <code>TLC_FALSE</code> .
<code>LibSetAsyncClockTicks</code>	Returns code that sets <code>clockTick</code> counters that are to be maintained by the asynchronous task.
<code>LibSetAsyncCounter</code>	Generates code to set the tick value of the block's asynchronous counter.
<code>LibSetAsyncCounterHighWord</code>	Generates code to set the tick value of the high word of the block's asynchronous counter

## Import Asynchronous Event Data for Simulation

**Capabilities.** You can import asynchronous event data into a function-call subsystem via an Inport block. For standalone fixed-step simulations, you can specify:

- The time points at which each asynchronous event occurs
- The number of asynchronous events at each time point

**Input Data Format.** You can enter your asynchronous data at the MATLAB command line or on the **Data Import/Export** pane of the Configuration Parameters dialog box. In either case, a number of restrictions apply to the data format.

- The expression for the parameter **Data Import/Export > Input** must be a comma-separated list of tables, as described in “Enable Data Import”.
- The table corresponding to the input port outputting asynchronous events must be a column vector containing time values for the asynchronous events.
  - The time vector of the asynchronous events must be of double data type and monotonically increasing.
  - All time data must be integer multiples of the model step size.
  - To specify multiple function calls at a given time step, you must repeat the time value accordingly. In other words, if you wish to specify three asynchronous events at  $t = 1$  and two events at  $t = 9$ , then you must list 1 three times and 9 twice in your time vector. ( $t = [1\ 1\ 1\ 9\ 9]$ )
- The table corresponding to normal data input port can be of any other supported format as described in “Enable Data Import”.

**Example.** In this model, a function-call subsystem is used to track the total number of asynchronous events and to multiply a set of inputs by 2.

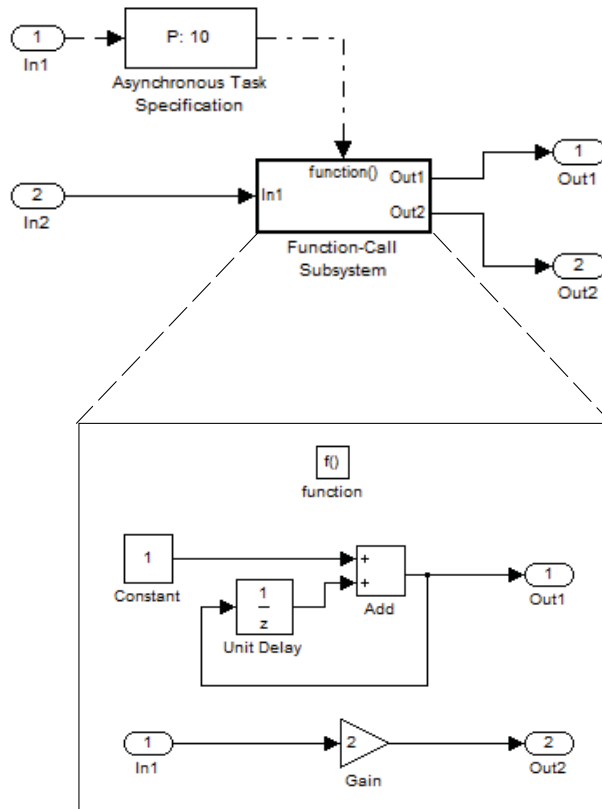

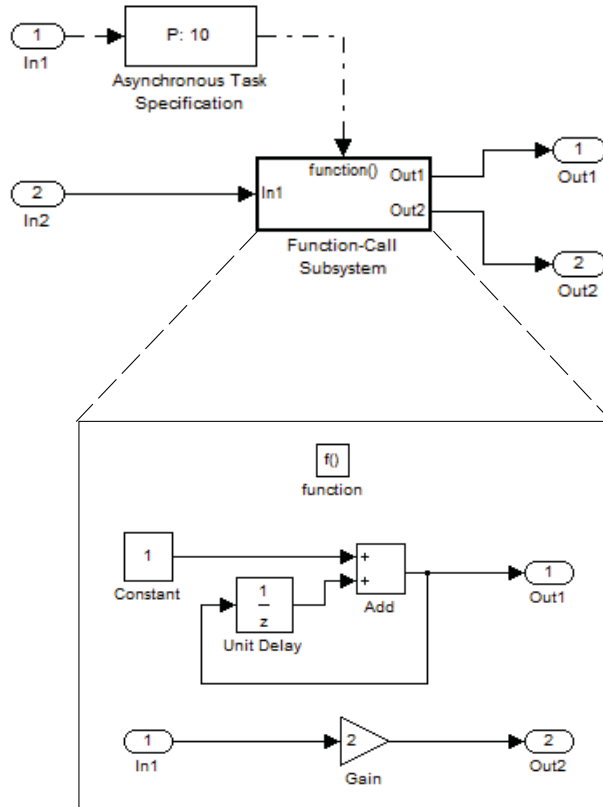

- 1 To input data via the Configuration Parameters dialog box,
  - a Select **Simulation > Configuration Parameters > Data Import/Export**.
  - b Select the **Input** parameter.
  - c For this example, enter the following command in the MATLAB window:

```
>> t = [1 1 5 9 9 9]', u = [[0:10]' [0:10]']
```

Alternatively, you can enter the data as  $t$ ,  $tu$  in the Data Import/Export pane:



The screenshot shows the 'Load from workspace' dialog box in MATLAB/Simulink. On the left is a 'Select:' pane with a tree view containing: Solver, Data Import/Export, Optimization, Diagnostics, Hardware Implementa..., Model Referencing, Simulation Target, Code Generation, and HDL Code Generation. The main dialog has two sections: 'Load from workspace' and 'Save to workspace'. In 'Load from workspace', 'Input' is checked and set to 't, tu', and 'Initial state' is unchecked and set to 'xInitial'. In 'Save to workspace', 'Time, State, Output' is selected. 'Time' is checked and set to 'tout', 'Format' is a dropdown set to 'Array', 'Limit data points to last' is checked and set to '1000', 'Output' is checked and set to 'yout', 'Decimation' is set to '1', and 'Final states' is unchecked and set to 'xFinal'. There is also an unchecked checkbox for 'Save complete SimState in final state'.

Here,  $t$  is a column vector containing the times of asynchronous events for Inport block In1 while  $tu$  is a table of input values versus time for Inport block In2.

- 2 By default, the **Time** and **Output** options are selected and the output variables are named  $tout$  and  $yout$ .
- 3 Simulate the model.
- 4 Display the output by entering `[tout yout]` at the MATLAB command line and obtain:

```
ans =
     0     0    -1
     1     2     2
     2     2     2
     3     2     2
     4     2     2
     5     3    10
     6     3    10
     7     3    10
     8     3    10
     9     6    18
    10     6    18
```

Here the first column contains the simulation times.

The second column represents the output of Out1 — the total number of asynchronous events. Since the function-call subsystem is triggered twice at  $t = 1$ , the output is 2. It is not called again until  $t = 5$ , and so does not increase to 3 until then. Finally, it is called three times at 9, so it increases to 6.

The third column contains the output of Out2 obtained by multiplying the input value at each asynchronous event time by 2. At any other time, the output is held at its previous value

## Asynchronous Support Limitations

- “Asynchronous Task Priority” on page 1-74
- “Convert an Asynchronous Subsystem into a Model Reference” on page 1-74

**Asynchronous Task Priority.** The Simulink product does not simulate asynchronous task behavior. Although you can specify a task priority for an asynchronous task represented in a model with the Task Sync block, the priority setting is for code generation purposes only and is not honored during simulation.

**Convert an Asynchronous Subsystem into a Model Reference.** You can use the Asynchronous Task Specification block to specify an asynchronous function-call input to a model reference. However, you must convert the Async Interrupt and Function-Call blocks into a subsystem and then convert the subsystem into a model reference.

Following is an example with step-by-step instructions for conversion.

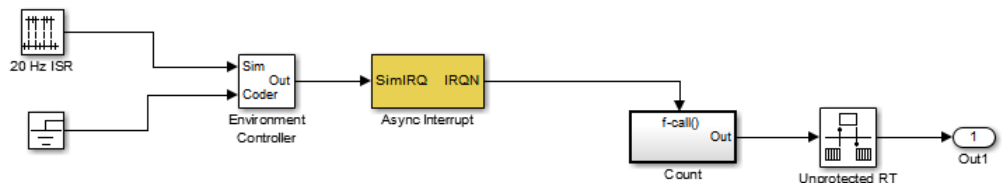

- 1 Convert the Async Interrupt and Count blocks into a subsystem. Select both blocks and right-click Count. From the menu, select **Subsystem & Model Reference > Create Subsystem from Selection**.

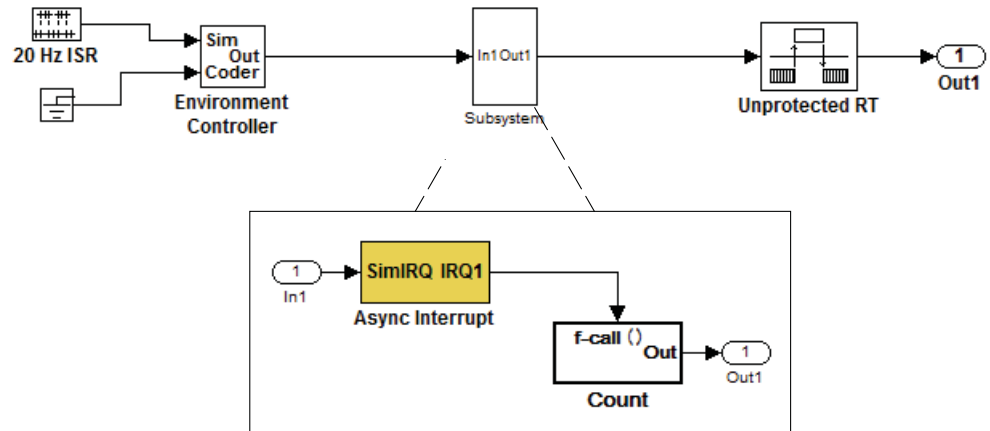

- 2 To prepare for converting the new subsystem to a Model block, set the following configuration parameters in the top model. Open the Configuration Parameters dialog box.
  - If you are simulating in Normal mode, then you must make the following change. From the Optimization node, navigate to the Signals and Parameters pane. Under **Simulation and code generation**, select the **Inline parameters** option.
  - From the Diagnostics node, navigate to the Sample Time pane. Then set **Multitask rate transition** to error and **Multitask conditionally executed subsystem** to error.
  - Under Diagnostics, navigate to the Data Validity pane and set the **Multitask data store** option to error and set the **Underspecified initialization detection** to Simplified. If your model is large or complex, in the Model Advisor, run the **Check consistency of initialization parameters for Outport and Merge blocks** check and make suggested changes.
  - Under Diagnostics, navigate to the Connectivity pane. Set **Mux blocks used to create bus signals, Bus signal treated as**

**vector**, and **Invalid function-call connection** to error. Also set **Context-dependent inputs** to **Enable All**.

- Convert the subsystem to an atomic subsystem. Select **Edit > Subsystem Parameters > Treat as atomic unit**.

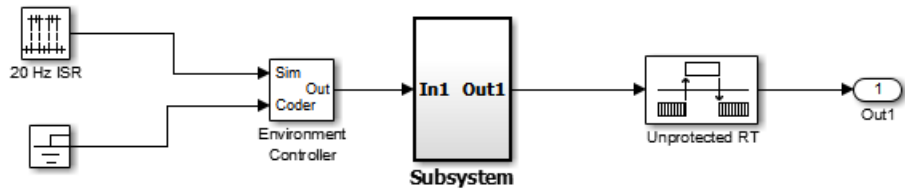
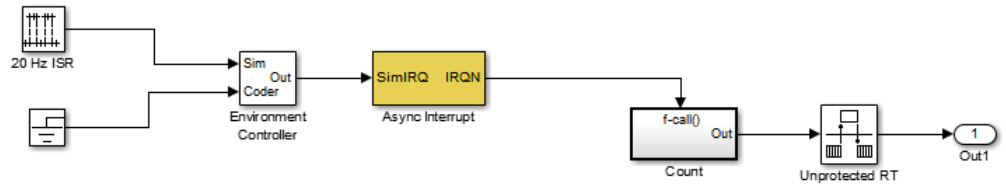

- Convert the subsystem to a Model block. Right-click the subsystem and select **Subsystem & Model Reference > Convert Subsystem to > Referenced Model**. A window opens with a model reference block inside of it.

- Replace the subsystem in the top model with the new model reference block.

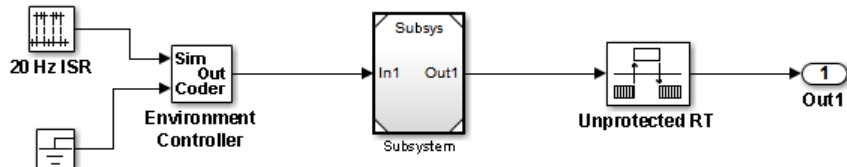

- Move the Async Interrupt block from the model reference to the top model, before the model reference block.

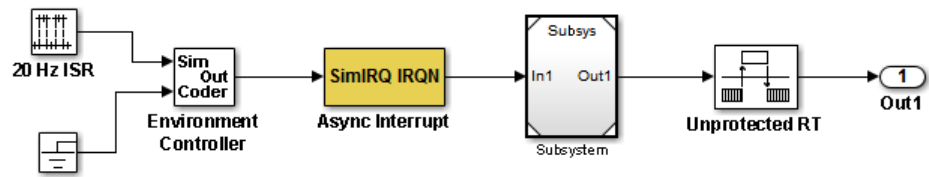

- 7** Insert an Asynchronous Task Specification block in the model reference. Set the priority of the Asynchronous Task Specification block. (For more information on setting the priority, see Asynchronous Task Specification.)

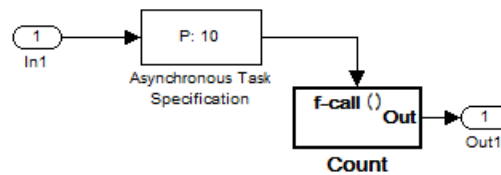

- 8** In the model reference, double-click the input port to open its Source Block Parameters dialog box. Click the **Signal Attributes** tab and select the **Output function call** option. Click **OK**.

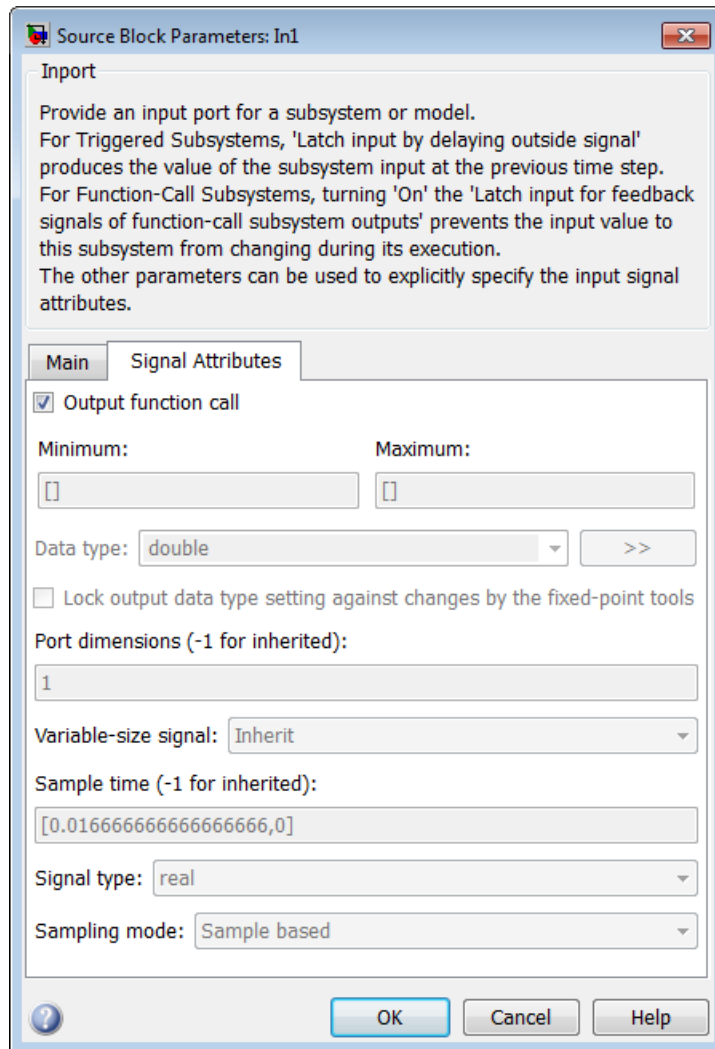

- 9 Save your model and then perform **Simulation > Update Diagram** to verify your settings.

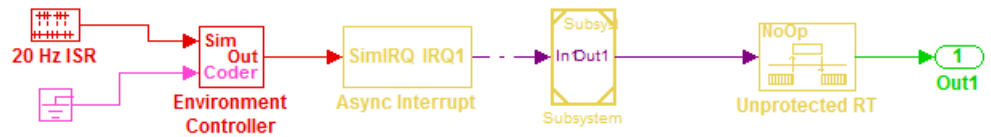

## Timers

- “Absolute and Elapsed Time Computation” on page 1-79
- “APIs for Accessing Timers” on page 1-81
- “Elapsed Timer Code Generation Example” on page 1-85
- “Limitations on the Use of Absolute Time” on page 1-88

## Absolute and Elapsed Time Computation

- “About Timers” on page 1-79
- “Timers for Periodic and Asynchronous Tasks” on page 1-80
- “Allocation of Timers” on page 1-80
- “Integer Timers in Generated Code” on page 1-81
- “Elapsed Time Counters in Triggered Subsystems” on page 1-81

**About Timers.** Certain blocks require the value of either *absolute* time (that is, the time from the start of program execution to the present time) or *elapsed* time (for example, the time elapsed between two trigger events). Targets that support the real-time model (`rtModel`) data structure provide efficient time computation services to blocks that request absolute or elapsed time. Absolute and elapsed timer features include

- Timers are implemented as unsigned integers in generated code.
- In multirate models, at most one timer is allocated per rate. If no blocks executing at a given rate require a timer, no timer is allocated to that rate. This minimizes memory allocated for timers and significantly reduces overhead involved in maintaining timers.

- Allocation of elapsed time counters for use of blocks within triggered subsystems is minimized, further reducing memory usage and overhead.
- The Simulink Coder product provides S-function and TLC APIs that let your S-functions access timers, in both simulation and code generation.
- The word size of the timers is determined by a user-specified maximum counter value, **Application lifespan (days)**. If you specify this value, timers will not overflow. For more information, see “Control Memory Allocation for Time Counters” on page 16-9.

See “Limitations on the Use of Absolute Time” on page 1-88 and “Blocks that Depend on Absolute Time” on page 1-89 for more information about absolute time and the restrictions that it imposes.

**Timers for Periodic and Asynchronous Tasks.** This chapter discusses timing services provided for blocks executing within *periodic* tasks (that is, tasks running at the model’s base rate or subrates).

The Simulink Coder product also provides timer support for blocks whose execution is *asynchronous* with respect to the periodic timing source of the model. See the following sections of the Asynchronous Support chapter:

- “Use Timers in Asynchronous Tasks” on page 1-58
- “Create a Customized Asynchronous Library” on page 1-60

**Allocation of Timers.** If you create or maintain an S-Function block that requires absolute or elapsed time data, it must register the requirement (see “APIs for Accessing Timers” on page 1-81). In multirate models, timers are allocated on a per-rate basis. For example, consider a model structured as follows:

- There are three rates, A, B, and C, in the model.
- No blocks running at rate B require absolute or elapsed time.
- Two blocks running at rate C register a requirement for absolute time.
- One block running at rate A registers a requirement for absolute time.

In this case, two timers are generated, running at rates A and C respectively. The timing engine updates the timers as the tasks associated with rates A



and C execute. Blocks executing at rates A and C obtain time data from the timers associated with rates A and C.

**Integer Timers in Generated Code.** In the generated code, timers for absolute and elapsed time are implemented as unsigned integers. The default size is 64 bits. This is the amount of memory allocated for a timer if you specify a value of `inf` for the **Application lifespan (days)** parameter. For an application with a sample rate of 1000 MHz, a 64-bit counter will not overflow for more than 500 years. See “Use Timers in Asynchronous Tasks” on page 1-58 and “Control Memory Allocation for Time Counters” on page 16-9 for more information.

**Elapsed Time Counters in Triggered Subsystems.** Some blocks, such as the Discrete-Time Integrator block, perform computations requiring the elapsed time ( $\Delta T$ ) since the previous block execution. Blocks requiring elapsed time data must register the requirement (see “APIs for Accessing Timers” on page 1-81). A triggered subsystem then allocates and maintains a single elapsed time counter if required. This timer functions at the subsystem level, not at the individual block level. The timer is generated if the triggered subsystem (or any unconditionally executed subsystem within the triggered subsystem) contains one or more blocks requiring elapsed time data.

---

**Note** If you are using simplified initialization mode, elapsed time is always reset on first execution after becoming enabled, whether or not the subsystem is configured to reset on enable. For more information, see “Underspecified initialization detection” in the Simulink documentation.

---

## APIs for Accessing Timers

- “About Timer APIs” on page 1-82
- “C API for S-Functions” on page 1-82
- “TLC API for Code Generation” on page 1-84

**About Timer APIs.** This section describes APIs that let your S-functions take advantage of the efficiencies offered by the absolute and elapsed timers. SimStruct macros are provided for use in simulation, and TLC functions are provided for inlined code generation. Note that

- To generate and use the new timers as described above, your S-functions must register the need to use an absolute or elapsed timer by calling `ssSetNeedAbsoluteTime` or `ssSetNeedElapseTime` in `mdlInitializeSampleTime`.
- Existing S-functions that read absolute time but do not register by using these macros will continue to operate as expected, but will generate old-style, less efficient code.

**C API for S-Functions.** The SimStruct macros described in this section provide access to absolute and elapsed timers for S-functions during simulation.

In the functions below, the SimStruct `*S` argument is a pointer to the `simstruct` of the calling S-function.

- `void ssSetNeedAbsoluteTime(SimStruct *S, boolean b)`: if `b` is `TRUE`, registers that the calling S-function requires absolute time data, and allocates an absolute time counter for the rate at which the S-function executes (if such a counter has not already been allocated).
- `int ssGetNeedAbsoluteTime(SimStruct *S)`: returns 1 if the S-function has registered that it requires absolute time.
- `double ssGetTaskTime(SimStruct *S, tid)`: read absolute time for a given task with task identifier `tid`. `ssGetTaskTime` operates transparently, regardless of whether or not you use the new timer features. `ssGetTaskTime` is documented in the SimStruct Functions chapter of the Simulink documentation.
- `void ssSetNeedElapseTime(SimStruct *S, boolean b)`: if `b` is `TRUE`, registers that the calling S-function requires elapsed time data, and allocates an elapsed time counter for the triggered subsystem in which the S-function executes (if such a counter has not already been allocated). See also “Elapsed Time Counters in Triggered Subsystems” on page 1-81.

- `int ssGetNeedElapseTime(SimStruct *S)`: returns 1 if the S-function has registered that it requires elapsed time.
- `void ssGetElapseTime(SimStruct *S, (double *)elapseTime)`: returns, to the location pointed to by `elapseTime`, the value (as a double) of the elapsed time counter associated with the S-function.
- `void ssGetElapseTimeCounterDtype(SimStruct *S, (int *)dtype)`: returns the data type of the elapsed time counter associated with the S-function to the location pointed to by `dtype`. This function is intended for use with the `ssGetElapseTimeCounter` function (see below).
- `void ssGetElapseResolution(SimStruct *S, (double *)resolution)`: returns the resolution (that is, the sample time) of the elapsed time counter associated with the S-function to the location pointed to by `resolution`. This function is intended for use with the `ssGetElapseTimeCounter` function (see below).
- `void ssGetElapseTimeCounter(SimStruct *S, (void *)elapseTime)`: This function is provided for the use of blocks that require the elapsed time values for fixed-point computations. `ssGetElapseTimeCounter` returns, to the location pointed to by `elapseTime`, the integer value of the elapsed time counter associated with the S-function. If the counter size is 64 bits, the value is returned as an array of two 32-bit words, with the low-order word stored at the lower address.

To determine how to access the returned counter value, obtain the data type of the counter by calling `ssGetElapseTimeCounterDtype`, as in the following code:

```
int    *y_dtype;
ssGetElapseTimeCounterDtype(S, y_dtype);

switch(*y_dtype) {
    case SS_DOUBLE_UINT32:
        {
            uint32_T dataPtr[2];
            ssGetElapseTimeCounter(S, dataPtr);
        }
        break;
    case SS_UINT32:
        {
            uint32_T dataPtr[1];
```

```

        ssGetElapseTimeCounter(S, dataPtr);
    }
    break;
case SS_UINT16:
    {
        uint16_T dataPtr[1];
        ssGetElapseTimeCounter(S, dataPtr);
    }
    break;
case SS_UINT8:
    {
        uint8_T dataPtr[1];
        ssGetElapseTimeCounter(S, dataPtr);
    }
    break;
case SS_DOUBLE:
    {
        real_T dataPtr[1];
        ssGetElapseTimeCounter(S, dataPtr);
    }
    break;
default:
    ssSetErrorStatus(S, "Invalid data type for elapse time
        counter");
    break;
}

```

If you want to use the actual elapsed time, issue a call to the `ssGetElapseTime` function to access the elapsed time directly. You do not need to get the counter value and then calculate the elapsed time.

```

double *y_elapseTime;
.
.
.
ssGetElapseTime(S, elapseTime)

```

**TLC API for Code Generation.** The following TLC functions support elapsed time counters in generated code when you inline S-functions by writing TLC scripts for them.

- `LibGetTaskTimeFromTID(block)`: Generates code to read the absolute time for the task in which `block` executes.

`LibGetTaskTimeFromTID` is documented with other sample time functions in the TLC Function Library Reference pages of the Target Language Compiler documentation.

---

**Note** Do not use `LibGetT` for this purpose. `LibGetT` always reads the base rate (`tid 0`) timer. If `LibGetT` is called for a block executing at a subrate, the wrong timer is read, causing serious errors.

---

- `LibGetElapseTime(system)`: Generates code to read the elapsed time counter for `system`. (`system` is the parent system of the calling block.) See “Elapsed Timer Code Generation Example” on page 1-85 for an example of code generated by this function.
- `LibGetElapseTimeCounter(system)`: Generates code to read the integer value of the elapsed time counter for `system`. (`system` is the parent system of the calling block.) This function should be used in conjunction with `LibGetElapseTimeCounterDtypeId` and `LibGetElapseTimeResolution`. (See the discussion of `ssGetElapseTimeCounter` above.)
- `LibGetElapseTimeCounterDtypeId(system)`: Generates code that returns the data type of the elapsed time counter for `system`. (`system` is the parent system of the calling block.)
- `LibGetElapseTimeResolution(system)`: Generates code that returns the resolution of the elapsed time counter for `system`. (`system` is the parent system of the calling block.)

### Elapsed Timer Code Generation Example

This section shows a simple model illustrating how an elapsed time counter is generated and used by a Discrete-Time Integrator block within a triggered subsystem. The following block diagrams show the model `elapseTime_exp`, which contains subsystem `Amplifier`, which includes a Discrete-Time Integrator block.

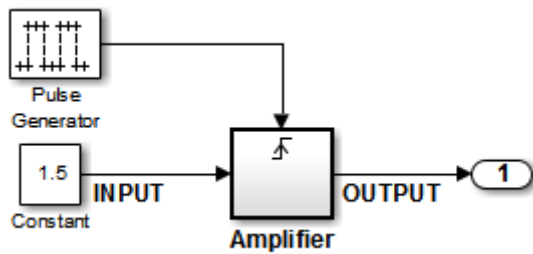

### elapsedTime\_exp Model

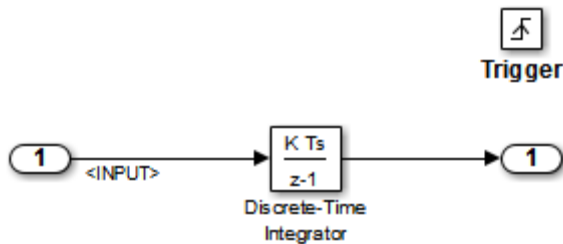

### Amplifier Subsystem

A 32-bit timer for the base rate (the only rate in this model) is defined within the `rtModel` structure, as follows, in `model.h`.

```

-/*
 * Timing:
 * The following substructure contains information regarding
 * the timing information for the model.
 */
struct {
    time_T stepSize;
    uint32_T clockTick0;
    uint32_T clockTickH0;
    time_T stepSize0;
    time_T tStart;
    time_T tFinal;
    time_T timeOfLastOutput;
    void *timingData;
    real_T *varNextHitTimesList;

```

```

    SimTimeStep simTimeStep;
    boolean_T stopRequestedFlag;
    time_T *sampleTimes;
    time_T *offsetTimes;
    int_T *sampleTimeTaskIDPtr;
    int_T *sampleHits;
    int_T *perTaskSampleHits;
    time_T *t;
    time_T sampleTimesArray[1];
    time_T offsetTimesArray[1];
    int_T sampleTimeTaskIDArray[1];
    int_T sampleHitArray[1];
    int_T perTaskSampleHitsArray[1];
    time_T tArray[1];
} Timing;

```

Had the target been ERT instead of GRT, the `Timing` structure would have been pruned to contain only the data required by the model, as follows:

```

/* Real-time Model Data Structure */ (for ERT!)
struct _RT_MODEL_elapseTime_exp_Tag {

    /*
     * Timing:
     * The following substructure contains information regarding
     * the timing information for the model.
     */
    struct {
        uint32_T clockTick0;
    } Timing;
};

```

Storage for the previous-time value of the Amplifier subsystem (`Amplifier_PREV_T`) is allocated in the `D_Work(states)` structure in `model.h`.

```

typedef struct D_Work_elapseTime_exp_tag {
    real_T DiscreteTimeIntegrator_DSTATE; /* '<S1>/Discrete-Time
                                           Integrator' */
    int32_T clockTickCounter;             /* '<Root>/Pulse Generator' */
    uint32_T Amplifier_PREV_T;           /* '<Root>/Amplifier' */
} D_Work_elapseTime_exp;

```

These structures are declared in *model.c*:

```
/* Block states (auto storage) */
D_Work_elapseTime_exp elapseTime_exp_DWork;
.
.
.
/* Real-time model */
rtModel_elapseTime_exp elapseTime_exp_M;
rtModel_elapseTime_exp *elapseTime_exp_M = &elapseTime_exp_M;
```

The elapsed time computation is performed as follows within the *model\_step* function:

```
/* Output and update for trigger system: '<Root>/Amplifier' */
uint32_T rt_currentTime =
    ((uint32_T)elapseTime_exp_M->Timing.clockTick0);
uint32_T rt_elapseTime = rt_currentTime -
    elapseTime_exp_DWork.Amplifier_PREV_T;
elapseTime_exp_DWork.Amplifier_PREV_T = rt_currentTime;
```

As shown above, the elapsed time is maintained as a state of the triggered subsystem. The Discrete-Time Integrator block finally performs its output and update computations using the elapsed time.

```
/* DiscreteIntegrator: '<S1>/Discrete-Time Integrator' */
OUTPUT = elapseTime_exp_DWork.DiscreteTimeIntegrator_DSTATE;

/* Update for DiscreteIntegrator: '<S1>/Discrete-Time Integrator'*/
elapseTime_exp_DWork.DiscreteTimeIntegrator_DSTATE += 0.3 *
    (real_T)rt_elapseTime * 1.5 ;
```

Because the triggered subsystem maintains the elapsed time, the TLC implementation of the Discrete-Time Integrator block needs only a single call to `LibGetElapseTime` to access the elapsed time value.

## Limitations on the Use of Absolute Time

- “About Absolute Time Limitations” on page 1-89
- “Logging Absolute Time” on page 1-89



- “Absolute Time in Stateflow Charts” on page 1-89
- “Blocks that Depend on Absolute Time” on page 1-89

**About Absolute Time Limitations.** *Absolute time* is the time that has elapsed from the beginning of program execution to the present time, as distinct from *elapsed time*, the interval between two events. See “Absolute and Elapsed Time Computation” on page 1-79 for more information.

When you design an application that is intended to run indefinitely, you must take care when logging time values, or using charts or blocks that depend on absolute time. If the value of time reaches the largest value that can be represented by the data type used by the timer to store time, the timer overflows and the logged time or block output is incorrect.

If your target uses `rtModel`, you can avoid timer overflow by specifying a value for the **Application life span** parameter. See “Integer Timers in Generated Code” on page 1-81 for more information.

**Logging Absolute Time.** If you log time values by opening the Configuration Parameters dialog box and enabling **Data Import/Export > Save to workspace > Time**, your model uses absolute time.

**Absolute Time in Stateflow Charts.** Every Stateflow chart that uses time is dependent on absolute time. The only way to eliminate the dependency is to change the Stateflow chart to not use time.

**Blocks that Depend on Absolute Time.** The following Simulink blocks depend on absolute time:

- Backlash
- Chirp Signal
- Clock
- Derivative
- Digital Clock
- Discrete-Time Integrator (only when used in triggered subsystems)
- From File

- From Workspace
- Pulse Generator
- Ramp
- Rate Limiter
- Repeating Sequence
- Signal Generator
- Sine Wave (only when the **Sine type** parameter is set to Time-based)
- Step
- To File
- To Workspace (only when logging to StructureWithTime format)
- Transport Delay
- Variable Time Delay
- Variable Transport Delay

In addition to the Simulink blocks above, blocks in other blocksets may depend on absolute time. See the documentation for the blocksets that you use.

## **Configure Scheduling**

- “Configure Start and Stop Times” on page 1-90
- “Configure the Solver Type” on page 1-91
- “Configure the Tasking Mode” on page 1-91

For details about solver options, see “Solver Pane” in the Simulink reference documentation.

### **Configure Start and Stop Times**

The **Stop time** must be greater than or equal to the **Start time**. If the stop time is zero, or if the total simulation time (**Stop** minus **Start**) is less than zero, the generated program runs for one step. If the stop time is set to `inf`, the generated program runs indefinitely.

When using the GRT or Wind River Systems Tornado targets, you can override the stop time when running a generated program from the Microsoft Windows command prompt or UNIX<sup>1</sup> command line. To override the stop time that was set during code generation, use the `-tf` switch.

```
model -tf n
```

The program runs for `n` seconds. If `n = inf`, the program runs indefinitely.

Certain blocks have a dependency on absolute time. If you are designing a program that is intended to run indefinitely (**Stop time = inf**), and your generated code does not use the `rtModel` data structure (that is, it uses `simstructs` instead), you must not use these blocks. See “Limitations on the Use of Absolute Time” on page 1-88 for a list of blocks that can potentially overflow timers.

If you know how long an application that depends on absolute time needs to run, you can prevent the timers from overflowing and force the use of optimal word sizes by specifying the **Application lifespan (days)** parameter on the **Optimization** pane. See “Control Memory Allocation for Time Counters” on page 16-9 for details.

## Configure the Solver Type

For code generation, you must configure a model to use a fixed-step solver for all targets except the S-function and RSim targets. You can configure the S-function and RSim targets with a fixed-step or variable-step solver.

## Configure the Tasking Mode

The Simulink Coder product supports both single-tasking and multitasking modes for periodic sample times. See “Scheduling” on page 1-4 for details.

---

1. UNIX<sup>®</sup> is a registered trademark of The Open Group in the United States and other countries.

## Supported Products and Block Usage

In this section...
“Related Products” on page 1-92
“Simulink Built-In Blocks That Support Code Generation” on page 1-94
“Block Set Support for Code Generation” on page 1-116
“Fixed-Point Tool Data Type Override” on page 1-116
“Data Type Overrides Unavailable for Most Blocks in Embedded Targets and Desktop Targets” on page 1-116

### Related Products

The following table summarizes MathWorks® products that extend and complement Simulink Coder software. For information about these and other MathWorks products, see [www.mathworks.com](http://www.mathworks.com).

Product	Extends Code Generation Capabilities for ...
Aerospace Blockset™	Aircraft, spacecraft, rocket, propulsion systems, and unmanned airborne vehicles
Communications System Toolbox™	Physical layer of communication systems
Computer Vision System Toolbox™	Video processing, image processing, and computer vision systems
Control System Toolbox™	Linear control systems
DSP System Toolbox™	Signal processing systems
Embedded Coder	Embedded systems, on-target rapid prototyping boards, microprocessors in mass production, and real-time simulators
Fuzzy Logic Toolbox™	System designs based on fuzzy logic
Gauges Blockset™	Linking generated code executing on a target system with graphical instrumentation in a Simulink model

<b>Product</b>	<b>Extends Code Generation Capabilities for ...</b>
Model-Based Calibration Toolbox™	Developing processes for systematically identifying optimal balance of engine performance, emissions, and fuel economy, and reusing statistical models for control design, hardware-in-the-loop testing, or powertrain simulation
Model Predictive Control Toolbox™	Controllers that optimize performance of multi-input and multi-output systems that are subject to input and output constraints
Real-Time Windows Target™	Rapid prototyping or hardware-in-the-loop simulation of control system and signal processing algorithms
SimDriveline™	Driveline (drivetrain) systems
SimElectronics®	Electronic and electromechanical systems
SimHydraulics®	Hydraulic power and control systems
SimMechanics™	Three-dimensional mechanical systems
SimPowerSystems™	Systems that generate, transmit, distribute, and consume electrical power
Simscape™	Systems spanning mechanical, electrical, hydraulic, and other physical domains as physical networks
Simulink Fixed Point™	Control and signal processing systems implemented with fixed-point arithmetic
Simulink 3D Animation™	Systems with 3D visualizations
Simulink Design Optimization™	Systems requiring maximum overall system performance
Simulink Report Generator™	Automatically generating project documentation in a standard format

<b>Product</b>	<b>Extends Code Generation Capabilities for ...</b>
Simulink Verification and Validation™	Applications requiring automated requirements tracing, model standards compliance checking, and test harness generation
System Identification Toolbox™	Systems constructed from measured input-output data Support exceptions: <ul style="list-style-type: none"> <li>• Nonlinear IDNLGREY Model, IDDATA Source, IDDATA Sink, and estimator blocks</li> <li>• Nonlinear ARX models that contain custom regressors</li> <li>• neuralnet nonlinearities</li> <li>• customnet nonlinearities</li> </ul>
Vehicle Network Toolbox™	Support exception: CAN Configuration, CAN Receive, and CAN Transmit blocks in the CAN Communication library
xPC Target™	Rapid control prototyping, hardware-in-the-loop (HIL) simulation, and other real-time testing applications
xPC Target Embedded Option™	Deploying real-time embedded systems on a PC for production, data acquisition, calibration, and testing applications

## Simulink Built-In Blocks That Support Code Generation

The following tables summarize Simulink Coder and Embedded Coder support for Simulink blocks. There is a table for each block library. For each block, the second column indicates any support notes, which give information about the block for code generation. For more detail, including

data types each block supports, in the MATLAB Command Window, type `showblockdatatypetable`, or consult the block reference pages.

- Additional Math and Discrete: Additional Discrete on page 1-96
- Additional Math and Discrete: Increment/Decrement on page 1-97
- Continuous on page 1-97
- Discontinuities on page 1-98
- Discrete on page 1-99
- Logic and Bit Operations on page 1-101
- Lookup Tables on page 1-102
- Math Operations on page 1-103
- Model Verification on page 1-106
- Model-Wide Utilities on page 1-107
- Ports & Subsystems on page 1-107
- Signal Attributes on page 1-108
- Signal Routing on page 1-109
- Sinks on page 1-110
- Sources on page 1-112
- User-Defined on page 1-115

**Additional Math and Discrete: Additional Discrete**

Block	Support Notes
Fixed-Point State-Space	The Simulink Coder software does not explicitly group primitive blocks that constitute a nonatomic masked subsystem block in the generated code. This flexibility allows for more efficient code generation. In certain cases, you can achieve grouping by configuring the masked subsystem block to execute as an atomic unit by selecting the <b>Treat as atomic unit</b> option.
Transfer Fcn Direct Form II	<ul style="list-style-type: none"> <li data-bbox="724 630 1302 916">• The Simulink Coder software does not explicitly group primitive blocks that constitute a nonatomic masked subsystem block in the generated code. This flexibility allows for more efficient code generation. In certain cases, you can achieve grouping by configuring the masked subsystem block to execute as an atomic unit by selecting the <b>Treat as atomic unit</b> option.</li> <li data-bbox="724 933 1258 994">• Generated code might rely on <code>memcpy</code> or <code>memset</code> (<code>string.h</code>).</li> </ul>
Transfer Fcn Direct Form II Time Varying	
Unit Delay Enabled	
Unit Delay Enabled External IC	
Unit Delay Enabled Resettable	
Unit Delay Enabled Resettable External IC	
Unit Delay External IC	
Unit Delay Resettable	
Unit Delay Resettable External IC	
Unit Delay With Preview Enabled	
Unit Delay With Preview Enabled Resettable	
Unit Delay With Preview Enabled Resettable External RV	
Unit Delay With Preview Resettable	
Unit Delay With Preview Resettable External RV	



## Additional Math and Discrete: Increment/Decrement

Block	Support Notes
Decrement Real World	The Simulink Coder software does not explicitly group primitive blocks that constitute a nonatomic masked subsystem block in the generated code. This flexibility allows for more efficient code generation. In certain cases, you can achieve grouping by configuring the masked subsystem block to execute as an atomic unit by selecting the <b>Treat as atomic unit</b> option.
Decrement Stored Integer	
Decrement Time To Zero	Supports code generation.
Decrement To Zero	The Simulink Coder software does not explicitly group primitive blocks that constitute a nonatomic masked subsystem block in the generated code. This flexibility allows for more efficient code generation. In certain cases, you can achieve grouping by configuring the masked subsystem block to execute as an atomic unit by selecting the <b>Treat as atomic unit</b> option.
Increment Real World	
Increment Stored Integer	

## Continuous

Block	Support Notes
Derivative	Not recommended for production-quality code. Relates to resource limits and restrictions on speed and memory often found in embedded systems. The code generated can contain dynamic allocation and freeing of memory, recursion, additional memory overhead, and widely-varying execution times. While the code is functionally valid and generally acceptable in resource-rich environments, smaller embedded targets often cannot support such code.
Integrator	
Integrator Limited	
PID Controller	
PID Controller (2DOF)	
Second-Order Integrator	In general, consider using the Simulink Model Discretizer to map continuous blocks into discrete equivalents that support production code generation. To start the Model Discretizer, select <b>Analysis &gt; Control Design &gt; Model Discretizer</b> . One exception is the Second-Order Integrator block because, for this block, the Model Discretizer produces an approximate discretization.
Second-Order Integrator Limited	
State-Space	
Transfer Fcn	
Transport Delay	
Variable Time Delay	

**Continuous (Continued)**

Block	Support Notes
Variable Transport Delay	
Zero-Pole	

**Discontinuities**

Block	Support Notes
Backlash	Supports code generation.
Coulomb and Viscous Friction	The Simulink Coder software does not explicitly group primitive blocks that constitute a nonatomic masked subsystem block in the generated code. This flexibility allows for more efficient code generation. In certain cases, you can achieve grouping by configuring the masked subsystem block to execute as an atomic unit by selecting the <b>Treat as atomic unit</b> option.
Dead Zone	Supports code generation.
Dead Zone Dynamic	The Simulink Coder software does not explicitly group primitive blocks that constitute a nonatomic masked subsystem block in the generated code. This flexibility allows for more efficient code generation. In certain cases, you can achieve grouping by configuring the masked subsystem block to execute as an atomic unit by selecting the <b>Treat as atomic unit</b> option.
Hit Crossing	Not recommended for production code. Relates to resource limits and restrictions on speed and memory often found in embedded systems. Generated code can contain dynamic allocation and freeing of memory, recursion, additional memory overhead, and widely-varying execution times. While the code is functionally valid and generally acceptable in resource-rich environments, smaller embedded targets often cannot support such code. Usually, blocks evolve toward being suitable for production code. Thus, blocks suitable for production code remain suitable.
Quantizer	Supports code generation.
Rate Limiter	Cannot use inside a triggered subsystem hierarchy.

**Discontinuities (Continued)**

<b>Block</b>	<b>Support Notes</b>
Rate Limiter Dynamic	The Simulink Coder software does not explicitly group primitive blocks that constitute a nonatomic masked subsystem block in the generated code. This flexibility allows for more efficient code generation. In certain cases, you can achieve grouping by configuring the masked subsystem block to execute as an atomic unit by selecting the <b>Treat as atomic unit</b> option.
Relay	Support code generation.
Saturation	
Saturation Dynamic	The Simulink Coder software does not explicitly group primitive blocks that constitute a nonatomic masked subsystem block in the generated code. This flexibility allows for more efficient code generation. In certain cases, you can achieve grouping by configuring the masked subsystem block to execute as an atomic unit by selecting the <b>Treat as atomic unit</b> option.
Wrap To Zero	

**Discrete**

<b>Block</b>	<b>Support Notes</b>
Delay	Supports code generation.
Difference	<ul style="list-style-type: none"> <li>The Simulink Coder software does not explicitly group primitive blocks that constitute a nonatomic masked subsystem block in the generated code. This flexibility allows for more efficient code generation. In certain cases, you can achieve grouping by configuring the masked subsystem block to execute as an atomic unit by selecting the <b>Treat as atomic unit</b> option.</li> <li>Not recommended for production code. Relates to resource limits and restrictions on speed and memory often found in embedded systems. Generated code can contain dynamic allocation and freeing of memory, recursion, additional memory overhead, and widely-varying execution times. While the code is functionally valid and generally acceptable in resource-rich environments, smaller embedded targets often cannot support such code.</li> </ul>

**Discrete (Continued)**

Block	Support Notes
	Usually, blocks evolve toward being suitable for production code. Thus, blocks suitable for production code remain suitable.
Discrete Derivative	<ul style="list-style-type: none"> <li>• Generated code might rely on memcpy or memset (string.h).</li> <li>• Depends on absolute time when used inside a triggered subsystem hierarchy.</li> </ul>
Discrete Filter	Support code generation.
Discrete FIR Filter	
PID Controller	<ul style="list-style-type: none"> <li>• Generated code might rely on memcpy or memset (string.h).</li> </ul>
PID Controller (2DOF)	<ul style="list-style-type: none"> <li>• Depends on absolute time when used inside a triggered subsystem hierarchy.</li> </ul>
Discrete State-Space	Generated code might rely on memcpy or memset (string.h).
Discrete Transfer Fcn	
Discrete Zero-Pole	
Discrete-Time Integrator	Depends on absolute time when used inside a triggered subsystem hierarchy.
First-Order Hold	Not recommended for production code. Relates to resource limits and restrictions on speed and memory often found in embedded systems. Generated code can contain dynamic allocation and freeing of memory, recursion, additional memory overhead, and widely-varying execution times. While the code is functionally valid and generally acceptable in resource-rich environments, smaller embedded targets often cannot support such code. Usually, blocks evolve toward being suitable for production code. Thus, blocks suitable for production code remain suitable.
Memory	Support code generation.
Tapped Delay	

**Discrete (Continued)**

<b>Block</b>	<b>Support Notes</b>
Transfer Fcn First Order	The Simulink Coder software does not explicitly group primitive blocks that constitute a nonatomic masked subsystem block in the generated code. This flexibility allows for more efficient code generation. In certain cases, you can achieve grouping by configuring the masked subsystem block to execute as an atomic unit by selecting the <b>Treat as atomic unit</b> option.
Transfer Fcn Lead or Lag	
Transfer Fcn Real Zero	
Unit Delay	Generated code might rely on memcpy or memset (string.h).
Zero-Order Hold	Supports code generation.

**Logic and Bit Operations**

<b>Block</b>	<b>Support Notes</b>
Bit Clear	Support code generation.
Bit Set	
Bitwise Operator	
Combinatorial Logic	
Compare to Constant	
Compare to Zero	Generated code might rely on memcpy or memset (string.h).
Detect Change	
Detect Decrease	
Detect Fall Negative	
Detect Fall Nonpositive	
Detect Increase	
Detect Rise Nonnegative	
Detect Rise Positive	

## Logic and Bit Operations (Continued)

Block	Support Notes
Extract Bits	Support code generation.
Interval Test	
Interval Test Dynamic	
Logical Operator	
Relational Operator	
Shift Arithmetic	

## Lookup Tables

Block	Support Notes
Cosine	The Simulink Coder software does not explicitly group primitive blocks that constitute a nonatomic masked subsystem block in the generated code. This flexibility allows for more efficient code generation. In certain cases, you can achieve grouping by configuring the masked subsystem block to execute as an atomic unit by selecting the <b>Treat as atomic unit</b> check box.
Direct Lookup Table (n-D)	Support code generation.
Interpolation Using Prelookup	
1-D Lookup Table	
2-D Lookup Table	
n-D Lookup Table	
Lookup Table Dynamic Prelookup	
Sine	The Simulink Coder software does not explicitly group primitive blocks that constitute a nonatomic masked subsystem block in the generated code. This flexibility allows for more efficient code generation. In certain cases, you can achieve grouping by

**Lookup Tables (Continued)**

Block	Support Notes
	configuring the masked subsystem block to execute as an atomic unit by selecting the <b>Treat as atomic unit</b> option.

**Math Operations**

Block	Support Notes
Abs	Support code generation.
Add	
Algebraic Constraint	Ignored during code generation.
Assignment	Support code generation.
Bias	
Complex to Magnitude-Angle	
Complex to Real-Imag	
Divide	
Dot Product	
Find Nonzero Elements	
Gain	
Magnitude-Angle to Complex	
Math Function (10 <sup>u</sup> )	
Math Function (conj)	
Math Function (exp)	
Math Function (hermitian)	
Math Function (hypot)	
Math Function (log)	
Math Function (log10)	

**Math Operations (Continued)**

<b>Block</b>	<b>Support Notes</b>
Math Function (magnitude^2)	
Math Function (mod)	
Math Function (pow)	
Math Function (reciprocal)	
Math Function (rem)	
Math Function (square)	
Math Function (transpose)	
Matrix Concatenate	
MinMax	
MinMax Running Resettable	
Permute Dimensions	
Polynomial	
Product	
Product of Elements	
Real-Imag to Complex	
Reciprocal Sqrt	
Reshape	
Rounding Function	
Sign	
Signed Sqrt	



**Math Operations (Continued)**

<b>Block</b>	<b>Support Notes</b>
Sine Wave Function	<ul style="list-style-type: none"> <li>• Does not refer to absolute time when configured for sample-based operation. Depends on absolute time when in time-based operation.</li> <li>• Depends on absolute time when used inside a triggered subsystem hierarchy.</li> </ul>
Slider Gain	Support code generation.
Sqrt	
Squeeze	
Subtract	
Sum	
Sum of Elements	
Trigonometric Function	Functions <code>asinh</code> , <code>acosh</code> , and <code>atanh</code> are not supported by all compilers. If you use a compiler that does not support those functions, the software issues a warning for the block and the generated code fails to link.
Unary Minus	Support code generation.
Vector Concatenate	
Weighted Sample Time Math	

**Model Verification**

Block	Support Notes
Assertion	Supports code generation.
Check Discrete Gradient	Not recommended for production code. Relates to resource limits and restrictions on speed and memory often found in embedded systems. Generated code can contain dynamic allocation and freeing of memory, recursion, additional memory overhead, and widely-varying execution times. While the code is functionally valid and generally acceptable in resource-rich environments, smaller embedded targets often cannot support such code. Usually, blocks evolve toward being suitable for production code. Thus, blocks suitable for production code remain suitable.
Check Dynamic Gap	Support code generation.
Check Dynamic Lower Bound	
Check Dynamic Range	
Check Dynamic Upper Bound	
Check Input Resolution	Not recommended for production code. Relates to resource limits and restrictions on speed and memory often found in embedded systems. Generated code can contain dynamic allocation and freeing of memory, recursion, additional memory overhead, and widely-varying execution times. While the code is functionally valid and generally acceptable in resource-rich environments, smaller embedded targets often cannot support such code. Usually, blocks evolve toward being suitable for production code. Thus, blocks suitable for production code remain suitable.
Check Static Gap	
Check Static Lower Bound	
Check Static Range	
Check Static Upper Bound	

## Model-Wide Utilities

Block	Support Notes
Block Support Table	Ignored during code generation.
DocBlock	Uses the template symbol you specify for the <b>Embedded Coder Flag</b> block parameter to add comments to generated code. Requires an Embedded Coder license. For more information, see “Use a Simulink DocBlock to Add a Comment”.
Model Info	Ignored during code generation.
Timed-Based Linearization	
Trigger-Based Linearization	

## Ports & Subsystems

Block	Support Notes
Atomic Subsystem	Support code generation.
CodeReuse Subsystem	
Configurable Subsystem	
Enable	
Enabled Subsystem	
Enabled and Triggered Subsystem	
For Each	
For Each Subsystem	
For Iterator Subsystem	
Function-Call Generator	
Function-Call Split	
Function-Call Subsystem	
If	

**Ports & Subsystems (Continued)**

<b>Block</b>	<b>Support Notes</b>
If Action Subsystem	
Model	
Subsystem	
Switch Case	
Switch Case Action Subsystem	
Triggered Subsystem	
While Iterator Subsystem	

**Signal Attributes**

<b>Block</b>	<b>Support Notes</b>
Bus to Vector	Support code generation.
Data Type Conversion	
Data Type Conversion Inherited	
Data Type Duplicate	
Data Type Propagation	
Data Type Scaling Strip	
IC	Not recommended for production code. Relates to resource limits and restrictions on speed and memory often found in embedded systems. Generated code can contain dynamic allocation and freeing of memory, recursion, additional memory overhead, and widely-varying execution times. While the code is functionally valid and generally acceptable in resource-rich environments, smaller embedded targets often cannot support such code. Usually, blocks evolve toward being suitable for production code. Thus, blocks suitable for production code remain suitable.
Probe	Supports code generation.

**Signal Attributes (Continued)**

Block	Support Notes
Rate Transition	<ul style="list-style-type: none"> <li>Generated code might rely on memcpy or memset (string.h).</li> <li>Cannot use inside a triggered subsystem hierarchy.</li> </ul>
Signal Conversion	Support code generation.
Signal Specification	
Weighted Sample Time	
Width	

**Signal Routing**

Block	Support Notes
Bus Assignment	Support code generation.
Bus Creator	
Bus Selector	
Data Store Memory	
Data Store Read	
Data Store Write	
Demux	
Environment Controller	Not recommended for production code. Relates to resource limits and restrictions on speed and memory often found in embedded systems. Generated code can contain dynamic allocation and freeing of memory, recursion, additional memory overhead, and widely-varying execution times. While the code is functionally valid and generally acceptable in resource-rich environments, smaller embedded targets often cannot support such code. Usually, blocks evolve toward being suitable for production code. Thus, blocks suitable for production code remain suitable.

**Signal Routing (Continued)**

<b>Block</b>	<b>Support Notes</b>
From	Support code generation.
Goto	
Goto Tag Visibility	
Index Vector	
Manual Switch	Not recommended for production code. Relates to resource limits and restrictions on speed and memory often found in embedded systems. Generated code can contain dynamic allocation and freeing of memory, recursion, additional memory overhead, and widely-varying execution times. While the code is functionally valid and generally acceptable in resource-rich environments, smaller embedded targets often cannot support such code. Usually, blocks evolve toward being suitable for production code. Thus, blocks suitable for production code remain suitable.
Merge	When multiple signals connected to a Merge block have a non-Auto storage class, all non-Auto signals connected to that block must <i>be identically labeled and have the same storage class</i> . When Merge blocks connect directly to one another, these rules apply to all signals connected to Merge blocks in the group.
Multiport Switch	Support code generation.
Mux	
Selector	
Switch	Generated code might rely on memcpy or memset (string.h).

**Sinks**

<b>Block</b>	<b>Support Notes</b>
Display	Ignored for code generation.
Floating Scope	
Outport (Out1)	Supports code generation.

**Sinks (Continued)**

<b>Block</b>	<b>Support Notes</b>
Scope	Ignored for code generation.
Stop Simulation	<ul style="list-style-type: none"> <li>• Not recommended for production code. Relates to resource limits and restrictions on speed and memory often found in embedded systems. Generated code can contain dynamic allocation and freeing of memory, recursion, additional memory overhead, and widely-varying execution times. While the code is functionally valid and generally acceptable in resource-rich environments, smaller embedded targets often cannot support such code. Usually, blocks evolve toward being suitable for production code. Thus, blocks suitable for production code remain suitable.</li> <li>• Generated code stops executing when the stop condition is true.</li> </ul>
Terminator	Supports code generation.
To File	Not recommended for production code. Relates to resource limits and restrictions on speed and memory often found in embedded systems. Generated code can contain dynamic allocation and freeing of memory, recursion, additional memory overhead, and widely-varying execution times. While the code is functionally valid and generally acceptable in resource-rich environments, smaller embedded targets often cannot support such code. Usually, blocks evolve toward being suitable for production code. Thus, blocks suitable for production code remain suitable.
To Workspace	Ignored for code generation.
XY Graph	

## Sources

Block	Support Notes
Band-Limited White Noise	Cannot use inside a triggered subsystem hierarchy.
Chirp Signal	Not recommended for production code. Relates to resource limits and restrictions on speed and memory often found in embedded systems. Generated code can contain dynamic allocation and freeing of memory, recursion, additional memory overhead, and widely-varying execution times. While the code is functionally valid and generally acceptable in resource-rich environments, smaller embedded targets often cannot support such code. Usually, blocks evolve toward being suitable for production code. Thus, blocks suitable for production code remain suitable.
Clock	
Constant	Supports code generation.
Counter Free-Running	Not recommended for production code. Relates to resource limits and restrictions on speed and memory often found in embedded systems. Generated code can contain dynamic allocation and freeing of memory, recursion, additional memory overhead, and widely-varying execution times. While the code is functionally valid and generally acceptable in resource-rich environments, smaller embedded targets often cannot support such code. Usually, blocks evolve toward being suitable for production code. Thus, blocks suitable for production code remain suitable.
Counter Limited	<ul style="list-style-type: none"> <li data-bbox="506 630 1338 720">• The Simulink Coder software does not explicitly group primitive blocks that constitute a nonatomic masked subsystem block in the generated code. This flexibility allows for more efficient code generation. In certain cases, you can achieve grouping by configuring the masked subsystem block to execute as an atomic unit by selecting the <b>Treat as atomic unit</b> option.</li> <li data-bbox="506 720 1338 810">• Not recommended for production code. Relates to resource limits and restrictions on speed and memory often found in embedded systems. Generated code can contain dynamic allocation and freeing of memory, recursion, additional memory overhead, and widely-varying execution times. While the code is functionally valid and generally acceptable in resource-rich environments, smaller embedded targets often cannot support such code.</li> </ul>



**Sources (Continued)**

<b>Block</b>	<b>Support Notes</b>
	Usually, blocks evolve toward being suitable for production code. Thus, blocks suitable for production code remain suitable.
Digital Clock	Not recommended for production code. Relates to resource limits and restrictions on speed and memory often found in embedded systems. Generated code can contain dynamic allocation and freeing of memory, recursion, additional memory overhead, and widely-varying execution times. While the code is functionally valid and generally acceptable in resource-rich environments, smaller embedded targets often cannot support such code. Usually, blocks evolve toward being suitable for production code. Thus, blocks suitable for production code remain suitable.
Enumerated Constant	Supports code generation.
From File	Ignored for code generation.
From Workspace	
Ground	Support code generation.
Inport (In1)	
Pulse Generator	Cannot use inside a triggered subsystem hierarchy. Does not refer to absolute time when configured for sample-based operation. Depends on absolute time when in time-based operation.
Ramp	Not recommended for production code. Relates to resource limits and restrictions on speed and memory often found in embedded systems. Generated code can contain dynamic allocation and freeing of memory, recursion, additional memory overhead, and widely-varying execution times. While the code is functionally valid and generally acceptable in resource-rich environments, smaller embedded targets often cannot support such code. Usually, blocks evolve toward being suitable for production code. Thus, blocks suitable for production code remain suitable.
Random Number	Supports code generation.

**Sources (Continued)**

<b>Block</b>	<b>Support Notes</b>
Repeating Sequence	<ul style="list-style-type: none"> <li>• Not recommended for production code. Relates to resource limits and restrictions on speed and memory often found in embedded systems. Generated code can contain dynamic allocation and freeing of memory, recursion, additional memory overhead, and widely-varying execution times. While the code is functionally valid and generally acceptable in resource-rich environments, smaller embedded targets often cannot support such code. Usually, blocks evolve toward being suitable for production code. Thus, blocks suitable for production code remain suitable.</li> <li>• Consider using the Repeating Sequence Stair or Repeating Sequence Interpolated block instead.</li> </ul>
Repeating Sequence Interpolated	<ul style="list-style-type: none"> <li>• The Simulink Coder software does not explicitly group primitive blocks that constitute a nonatomic masked subsystem block in the generated code. This flexibility allows for more efficient code generation. In certain cases, you can achieve grouping by configuring the masked subsystem block to execute as an atomic unit by selecting the <b>Treat as atomic unit</b> option.</li> <li>• Cannot use inside a triggered subsystem hierarchy.</li> </ul>
Repeating Sequence Stair	<p>The Simulink Coder software does not explicitly group primitive blocks that constitute a nonatomic masked subsystem block in the generated code. This flexibility allows for more efficient code generation. In certain cases, you can achieve grouping by configuring the masked subsystem block to execute as an atomic unit by selecting the <b>Treat as atomic unit</b> option.</p>
Signal Builder	<p>Not recommended for production code. Relates to resource limits and restrictions on speed and memory often found in embedded systems. Generated code can contain dynamic allocation and freeing of memory, recursion, additional memory overhead, and widely-varying execution times. While the code is functionally valid and generally acceptable in resource-rich environments, smaller embedded targets often cannot support such code. Usually, blocks evolve toward being suitable for production code. Thus, blocks suitable for production code remain suitable.</p>
Signal Generator	

**Sources (Continued)**

<b>Block</b>	<b>Support Notes</b>
Sine Wave	<ul style="list-style-type: none"> <li>• Depends on absolute time when used inside a triggered subsystem hierarchy.</li> <li>• Does not refer to absolute time when configured for sample-based operation. Depends on absolute time when in time-based operation.</li> </ul>
Step	Not recommended for production code. Relates to resource limits and restrictions on speed and memory often found in embedded systems. Generated code can contain dynamic allocation and freeing of memory, recursion, additional memory overhead, and widely-varying execution times. While the code is functionally valid and generally acceptable in resource-rich environments, smaller embedded targets often cannot support such code. Usually, blocks evolve toward being suitable for production code. Thus, blocks suitable for production code remain suitable.
Uniform Random Number	Supports code generation.

**User-Defined**

<b>Block</b>	<b>Support Notes</b>
Fcn	Supports code generation.
Interpreted MATLAB Function	Consider using the MATLAB Function block instead.
Level-2 MATLAB S-Function	Ignored during code generation.
MATLAB Function	Supports code generation.
S-Function	S-functions that call into MATLAB are not supported for code generation.
S-Function Builder	

## Block Set Support for Code Generation

Several products that include blocks are available for you to consider for code generation. However, before using the blocks for one of these products, consult the documentation for that product to confirm whether any, all, or a subset of blocks support code generation.

## Fixed-Point Tool Data Type Override

SIL/PIL does not support signals with data types overridden by the Fixed-Point Tool **Data type override** parameter at the SIL/PIL component boundary.

You may see an exception message like the following:

```
Simulink.DataType object 'real_T' is not in scope
from 'mpil_mtrig_no_ic_preload/TmpSFcnForModelReference_unitInTopMdl'.
This error message is related to a hidden S-Function block.
```

There is no resolution for this issue.

## Data Type Overrides Unavailable for Most Blocks in Embedded Targets and Desktop Targets

When you attempt to perform a datatype override on a block, you may get an error message similar to the following example:

```
Error reported by S-function 'sfun_can_frame_splitter' in
'c2000_host_CAN_monitor/CAN Message Unpacking/CAN Message
Unpacking': Incompatible DataType or Size specified.
```

Data type overrides using the Fixed point tool are not available for blocks in Simulink Coder > Desktop Targets and Embedded Coder > Embedded Targets libraries that support fixed-point.

There is no resolution for this issue.

## Modeling Semantic Considerations

In this section...
“Data Propagation” on page 1-117
“Sample Time Propagation” on page 1-119
“Latches for Subsystem Blocks” on page 1-120
“Block Execution Order” on page 1-120
“Algebraic Loops” on page 1-122

### Data Propagation

The first stage of code generation is compilation of the block diagram. This stage is analogous to that of a C or C++ program. The compiler carries out type checking and preprocessing. Similarly, the Simulink engine verifies that input/output data types of block ports are consistent, line widths between blocks are of expected thickness, and the sample times of connecting blocks are consistent.

The Simulink engine propagates data from one block to the next along signal lines. The data propagated consists of

- Data type
- Line widths
- Sample times

You can verify what data types any given Simulink block supports by typing

```
showblockdatatypetable
```

at the MATLAB prompt, or (from the Help browser) clicking the command above.

The Simulink engine typically derives signal attributes from a source block. For example, the Inport block’s parameters dialog box specifies the signal attributes for the block.

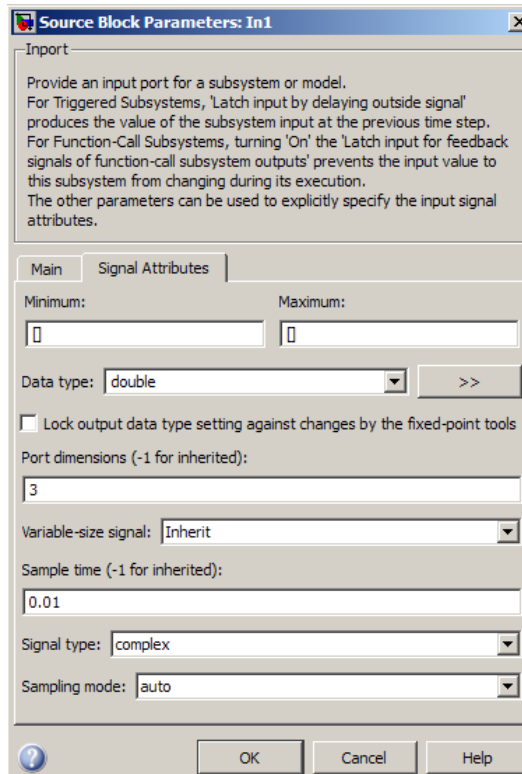

In this example, the Inport block has a port width of 3, a sample time of .01 seconds, the data type is double, and the signal is complex.

This figure shows the propagation of the signal attributes associated with the Inport block through a simple block diagram.

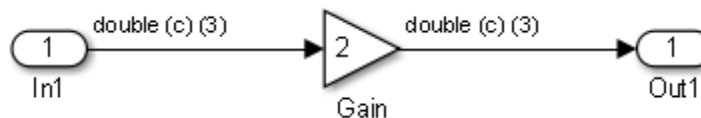

In this example, the Gain and Outport blocks inherit the attributes specified for the Inport block.

## Sample Time Propagation

Inherited sample times in source blocks (for example, a root inport) can sometimes lead to unexpected and unintended sample time assignments. Since a block may specify an inherited sample time, information available at the outset is often insufficient to compile a block diagram completely.

In such cases, the Simulink engine propagates the known or assigned sample times to those blocks that have inherited sample times but that have not yet been assigned a sample time. Thus, the engine continues to fill in the blanks (the unknown sample times) until sample times have been assigned to as many blocks as possible. Blocks that still do not have a sample time are assigned a default sample time.

For a completely deterministic model (one where no sample times are set using the above rules), you should explicitly specify the sample times of all your source blocks. Source blocks include root inport blocks and any blocks without input ports. You do not have to set subsystem input port sample times. You might want to do so, however, when creating modular systems.

An unconnected input implicitly connects to ground. For ground blocks and ground connections, the sample time is always constant (`inf`).

All blocks have an inherited sample time ( $T_s = -1$ ). They are assigned a sample time of  $(T_f - T_i)/50$ .

## Constant Block Sample Times

You can specify a sample time for Constant blocks. This has certain implications for code generation.

When a sample time of `inf` is selected for a Constant block,

- If **Inline parameters** is on, the block takes on a constant sample time, and propagates a constant sample time downstream.
- If **Inline parameters** is off, the Constant block inherits its sample time – which is nonconstant – and propagates that sample time downstream.

Generated code for any block differs when it has a constant sample time; its outputs are represented in the constant block outputs structure instead of in

the general block outputs structure. The generated code thus reflects that the Constant block propagates a constant sample time downstream if a sample time of `inf` is specified and **Inline parameters** is on.

## Latches for Subsystem Blocks

When an Inport block is the signal source for a triggered or function-call subsystem, you can use latch options to preserve input values while the subsystem executes. The Inport block latch options include:

For...	You Can Use...
Triggered subsystems	<b>Latch input by delaying outside signal</b>
Function-call subsystems	<b>Latch input for feedback signals of function-call subsystem outputs</b>

When you use **Latch input for feedback signals of function-call subsystem outputs** for a function-call subsystem, the Simulink Coder code generator

- Preserves latches in generated code regardless of any optimizations that might be set
- Places the code for latches at the start of a subsystem's output/update function

For more information on these options, see the description of the Inport block in the Simulink documentation.

## Block Execution Order

Once the Simulink engine compiles the block diagram, it creates a `model.rtw` file (analogous to an object file generated from a C or C++ file). The `model.rtw` file contains the connection information of the model, as well as the signal attributes. Thus, the timing engine in can determine when blocks with different rates should be executed.

You cannot override this execution order by directly calling a block (in handwritten code) in a model. For example, in the next figure the



`disconnected_trigger` model on the left has its trigger port connected to ground, which can lead to all blocks inheriting a constant sample time. Calling the trigger function,  $f()$ , directly from user code does not work and should never be done. Instead, you should use a function-call generator to specify the rate at which  $f()$  should be executed, as shown in the `connected_trigger` model on the right.

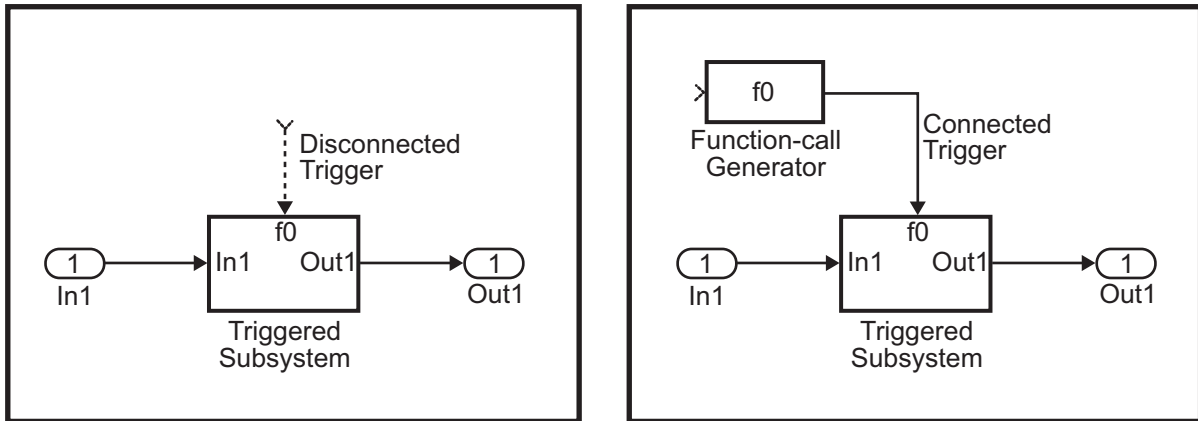

Instead of the function-call generator, you could use any other block that can drive the trigger port. Then, you should call the model's main entry point to execute the trigger function.

For multirate models, a common use of the Simulink Coder product is to build individual models separately and then manually code the I/O between the models. This approach places the burden of data consistency between models on the developer of the models. Another approach is to let the Simulink and Simulink Coder products maintain data consistency between rates and generate multirate code for use in a multitasking environment. The Simulink Rate Transition block is able to interface both periodic and asynchronous signals. For a description of the Simulink Coder libraries, see “Handle Asynchronous Events” on page 1-34. For more information on multirate code generation, see “Scheduling” on page 1-4.

## Algebraic Loops

Algebraic loops are circular dependencies between variables. This prevents the straightforward direct computation of their values. For example, in the case of a system of equations

- $x = y + 2$
- $y = -x$

the values of  $x$  and  $y$  cannot be directly computed.

To solve this, either repeatedly try potential solutions for  $x$  and  $y$  (in an intelligent manner, for example, using gradient based search) or “solve” the system of equations. In the previous example, solving the system into an explicit form leads to

- $2x = 2$
- $y = -x$
- $x = 1$
- $y = -1$

An algebraic loop exists whenever the output of a block having direct feedthrough (such as Gain, Sum, Product, and Transfer Fcn) is fed back as an input to the same block. The Simulink engine is often able to solve models that contain algebraic loops, such as the next diagram.

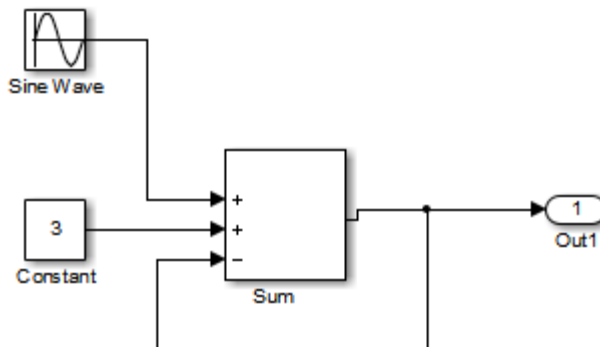

The Simulink Coder software does not produce code that solves algebraic loops. This restriction includes models that use Algebraic Constraint blocks in feedback paths. However, the Simulink engine can often eliminate all or some algebraic loops that arise, by grouping equations in certain ways in models that contain them. It does this by separating the update and output functions to avoid circular dependencies. See “Algebraic Loops” in the Simulink documentation for details.

### Algebraic Loops in Triggered Subsystems

While the Simulink engine can minimize algebraic loops involving atomic and enabled subsystems, a special consideration applies to some triggered subsystems. An example for which code can be generated is shown in the following model and triggered subsystem.

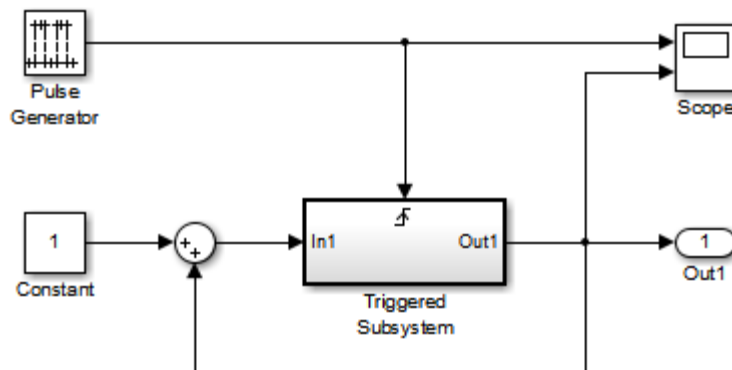

The default Simulink behavior is to combine output and update methods for the subsystem, which creates an apparent algebraic loop, even though the Unit Delay block in the subsystem has no direct feedthrough.

You can allow the Simulink engine to solve the problem by splitting the output and update methods of triggered and enabled-triggered subsystems when feasible. If you want the Simulink Coder code generator to take advantage of this feature, select the **Minimize algebraic loop occurrences** check box in the Subsystem Parameters dialog box. Select this option to avoid algebraic loop warnings in triggered subsystems involved in loops.

---

**Note** If you always check this box, the generated code for the subsystem might contain split output and update methods, even if the subsystem is not actually involved in a loop. Also, if a direct feedthrough block (such as a Gain block) is connected to the inport in the above triggered subsystem, the Simulink engine cannot solve the problem, and the Simulink Coder software is unable to generate code.

---

A similar **Minimize algebraic loop occurrences** option appears on the **Model Referencing** pane of the Configuration Parameters dialog box. Selecting it enables the Simulink Coder software to generate code for models containing Model blocks that are involved in algebraic loops.

# Subsystems

---

- “Code Generation of Subsystems” on page 2-2
- “Generate Code and Executables for Individual Subsystem” on page 2-4
- “Inline Subsystem Code” on page 2-7
- “Generate Subsystem Code as Separate Function and Files” on page 2-10
- “Generate Reusable Function for Identical Subsystems Within a Model” on page 2-11
- “Optimize Code for Identical Nested Subsystems” on page 2-14
- “Generate Reusable Code for Subsystems Containing S-Function Blocks” on page 2-15
- “Generate Reusable Code from Stateflow Charts” on page 2-16
- “Code Reuse Limitations for Subsystems” on page 2-17
- “Code Reuse For Subsystems Shared Across Referenced Models” on page 2-19
- “Reusable Library Subsystem” on page 2-20
- “Code Generation of Constant Parameters” on page 2-22
- “Shared Constant Parameters for Code Reuse” on page 2-23
- “Generate Reusable Code for Subsystems Shared Across Models” on page 2-25
- “Determine Why Subsystem Code Is Not Reused” on page 2-32

## Code Generation of Subsystems

For you to control how code is generated for any nonvirtual subsystem, the Simulink Coder software provides subsystem parameters that you can use. The categories of nonvirtual subsystems are:

- *Conditionally executed* subsystems. Execution depends upon a control signal or control block. These subsystems include:
  - Triggered
  - Enabled
  - Action
  - Iterator
  - Function-call

For more information, see “About Conditional Subsystems”.

- *Atomic* subsystems: Any virtual subsystem can be declared atomic (and therefore nonvirtual) by using the “Treat as atomic unit” parameter in the Subsystem Parameters dialog box.

For more information on nonvirtual subsystems and atomic subsystems, see “Systems and Subsystems” and run the `s1_subsys_semantics` model.

You can design and configure your model to control the code generated from nonvirtual subsystems.

To...	See...
Generate inlined code from a selected nonvirtual subsystem.	“Inline Subsystem Code” on page 2-7
Generate code for only a subsystem.	“Generate Code and Executables for Individual Subsystem” on page 2-4
Generate separate functions with no arguments, and optionally place the subsystem code in a separate file.	“Generate Subsystem Code as Separate Function and Files” on page 2-10

To...	See...
Generate a single reentrant function for a subsystem that is included in multiple places within a model.	“Generate Reusable Function for Identical Subsystems Within a Model” on page 2-11
Generate a single reentrant function for a subsystem that is included in multiple places in a model reference hierarchy.	“Generate Reusable Code for Subsystems Shared Across Models” on page 2-25 and “Code Reuse For Subsystems Shared Across Referenced Models” on page 2-19

---

**Note** If you generate code for a virtual subsystem, code generator treats the subsystem as atomic and generates the code accordingly. The resulting code can change the execution behavior of your model, for example, by applying algebraic loops, and therefore introduce inconsistencies with the simulation behavior. Declare virtual subsystems as atomic subsystems, which makes simulation and execution behavior consistent for your model consistent.

---

## Subsystem Code Dependence

Code generated from nonvirtual subsystems may or may not be completely independent of the generating model. When generating code for a subsystem, the code may reference global data structures of the model, even if the subsystem code is in a separate file. Each subsystem code file contains `include` directives and comments describing the dependencies. The Simulink Coder software checks for cyclic file dependencies and warns about them at build time. For descriptions of how generated code is packaged, see “Generated Source Files and File Dependencies” on page 10-4.

To generate subsystem code that is independent of the generating model, place the subsystem in a library and configure it as a reusable subsystem. For more information, see “Code Reuse For Subsystems Shared Across Referenced Models” on page 2-19.

## Generate Code and Executables for Individual Subsystem

You can generate code and build an executable for a subsystem within a model. The code generation and build process uses the code generation and build parameters of the root model.

- 1** In the Configuration Parameters dialog box, set up the code generation and build parameters, similar to setting up the code generation for a model.
- 2** Right-click the Subsystem block. From the context menu, select **C/C++ Code > Build This Subsystem** from the context menu.

Alternatively, in the current model, click a subsystem and then from the **Code** menu, select **C/C++ Code > Build Selected Subsystem**.

---

**Note** When you select **Build This Subsystem**, if the model is operating in external mode, the Simulink Coder build process automatically turns off external mode for the duration of the build. Simulink Coder then restores external mode upon completion of the build process.

---



- 3** The **Build code for Subsystem** window displays a list of the subsystem parameters. The upper pane displays the name, class, and storage class of each variable (or data object) that is referenced as a block parameter in the subsystem. When you select a parameter in the upper pane, the lower pane shows all the blocks that reference the parameter and the parent system of each block.

The **Storage Class** column contains a menu for each row. The menu options set the storage class or inline the parameter. To declare a parameter to be tunable, set the **Storage Class** to any value other than **Inlined**.

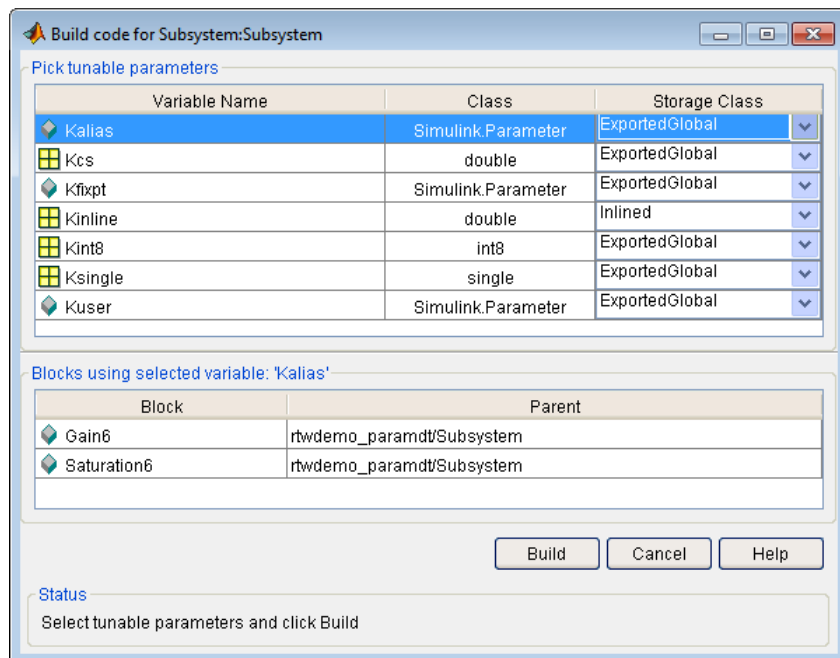

For more information on tunable and inlined parameters and storage classes, see “Parameters” on page 7-10.

- 4** After selecting tunable parameters, **Build** to initiate the code generation and build process.

- 5 The build process displays status messages in the MATLAB Command Window. When the build is complete, the generated executable is in your working folder. The name of the generated executable is *subsystem.exe* (on PC platforms) or *subsystem* (on The Open Group UNIX platforms). *subsystem* is the name of the source subsystem block.

The generated code is in a build subfolder, named *subsystem\_target\_rtw*. *subsystem* is the name of the source subsystem block and *target* is the name of the target configuration.

When you generate code for a subsystem, you can generate an S-function by selecting **Code > C/C++ Code > Generate S-Function**, or you can use the right-click subsystem build. For more information on S-functions, see “Automate S-Function Generation” on page 14-23 and in Embedded Coder, “Generate S-Function Wrappers”.

## Subsystem Build Limitations

The following limitations apply to building subsystems:

- When you right-click build a subsystem that includes an Outport block for which the **Data type** parameter specifies a bus object, you must address errors that result from setting signal labels. To configure the software to display these errors, in the Configuration Parameters dialog box for the parent model, on the **Diagnostics > Connectivity** pane, set the **Signal label mismatch** parameter to error.
- When a subsystem is in a triggered or function-call subsystem, the right-click build process might fail if the subsystem code is not sample-time independent. To find out whether a subsystem is sample-time independent:
  - 1 Copy all blocks in the subsystem to an empty model.
  - 2 In the Configuration Parameters dialog box, on the **Solver** pane, set:
    - a. **Type** to Fixed-step.
    - b. **Periodic sample time constraint** to Ensure sample time independent.
    - c. Click **Apply**.
  - 3 Update the model. If the model is sample-time dependent, Simulink generates an error in the process of updating the diagram.

## Inline Subsystem Code

You can configure a nonvirtual subsystem to inline the subsystem code with the model code. In the Subsystem Parameters dialog box, setting the **Function packaging** parameter to **Auto** or **Inline** inlines the generated code of the subsystem.

The **Auto** option is the default. When there is only one instance of a subsystem in the model, the **Auto** option inlines the subsystem code. When multiple instances of a subsystem exist, the **Auto** option results in a single copy of the function (as a reusable function). For function-call subsystems with multiple callers, the subsystem code is generated as if you specified **Function**.

To always inline subsystem code, select **Inline**. The **Inline** option explicitly directs the code generator to inline the subsystem unconditionally.

### Configure Subsystem to Inline Code

To configure your subsystem for inlining:

- 1** Right-click the Subsystem block. From the context menu, select **Block Parameters (Subsystem)**.
- 2** In the Subsystem Parameters dialog box, if the subsystem is virtual, select **Treat as atomic unit**. This option makes the subsystem nonvirtual. On the **Code Generation** tab, the **Function packaging** option is now available.

If the system is already nonvirtual, the **Function packaging** option is already selected.

- 3** Click the **Code Generation** tab and select **Auto** or **Inline** from the **Function packaging** parameter.

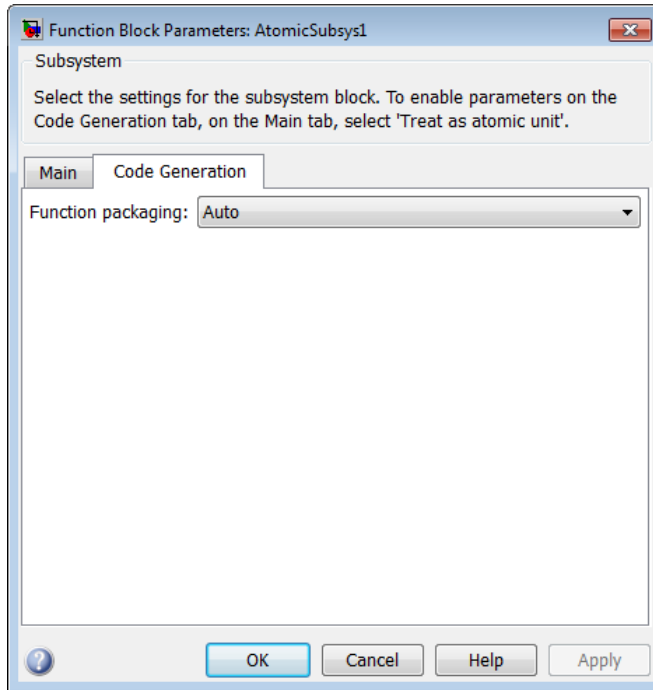

**4** Click **Apply** and close the dialog box.

The border of the subsystem thickens, indicating that it is nonvirtual.

When you generate code from your model, the code generator inlines subsystem code within *model.c* or *model.cpp* (or in its parent system's source file). You can identify this code by system/block identification tags, such as:

```
/* Atomic SubSystem Block: <Root>/AtomicSubsys1 */
```

### Exceptions to Inlining

There are certain cases in which the code generator does not inline a nonvirtual subsystem, even though the **Inline** option is selected.

- If the subsystem is a function-call subsystem that is called by a noninlined S-function, the **Inline** option is ignored. Noninlined S-functions make calls

by using function pointers. Therefore, the function-call subsystem must generate a function with all arguments present.

- In a feedback loop involving function-call subsystems, the code generator forces one of the subsystems to be generated as a function instead of inlining it. Based on the order in which the subsystems are sorted internally, the software selects the subsystem to be generated as a function.
- If a subsystem is called from an S-function block that sets the option `SS_OPTION_FORCE_NONINLINED_FCNCALL` to `TRUE`, it is not inlined. When user-defined Async Interrupt blocks or Task Sync blocks are present, this result might occur. Such blocks must be generated as functions. These blocks are located in the VxWorks block library (`vxlib1`) shipped with the Simulink Coder product and use the `SS_OPTION_FORCE_NONINLINED_FCNCALL` option.<sup>2</sup>

---

2. VxWorks® is a registered trademark of Wind River® Systems, Inc.

## Generate Subsystem Code as Separate Function and Files

To generate both a separate subsystem function and a separate file for a subsystem in a model:

- 1** Right-click a Subsystem block. From the context menu, select **Block Parameters (Subsystem)**.
- 2** In the Subsystem Parameters dialog box, if the subsystem is virtual, select **Treat as atomic unit**. On the **Code Generation** tab, the **Function packaging** parameter is now available.
- 3** Click the **Code Generation** tab and select **Function** from the **Function packaging** parameter. The **Function** option enables two parameters:
  - The “Function name options” parameter controls the naming of the generated function.
  - The “File name options” parameter controls the naming of the generated file.
- 4** Set the **Function name options** parameter.
- 5** Set the **File name options** parameter to a value other than **Auto**. If you are generating a reusable function for your subsystem, see “Generate Reusable Function for Identical Subsystems Within a Model” on page 2-11 or “Generate Reusable Code for Subsystems Shared Across Models” on page 2-25.
- 6** Click **Apply** and close the dialog box.

## Generate Reusable Function for Identical Subsystems Within a Model

In the Subsystem Parameters dialog box, the **Function packaging** parameter option `Function` generates functions that use global data. The `Reusable` function option generates reusable functions that have data passed as arguments (enabling them to be reentrant). Selecting `Reusable` function generates a function with arguments that allows the subsystem code to be shared by other instances of it in the model. This action supports less code instead of replicating the code for each instance of a subsystem or each time it is called.

To determine reusability of the subsystem code, the code generator performs a checksum to determine if subsystems are identical. The generated function has arguments, for example, for block inputs and outputs (`rtB_*`), continuous states (`rtDW_*`), parameters (`rtP_*`).

---

**Note** In the generated code, the call interface is subject to change from release to release. Therefore, do not directly call reusable functions from external code.

---

To generate one reusable function for identical subsystems within a model:

- 1 Right-click the Subsystem block. From the context menu, select **Block Parameters (Subsystem)**.
- 2 In the Subsystem Parameters dialog box, if the subsystem is virtual, select **Treat as atomic unit**. On the **Code Generation** tab, the **Function packaging** menu is now available.

If the subsystem is already nonvirtual, the **Function packaging** menu is already selected.

- 3 Click the **Code Generation** tab and select `Reusable` function for the **Function packaging** parameter.

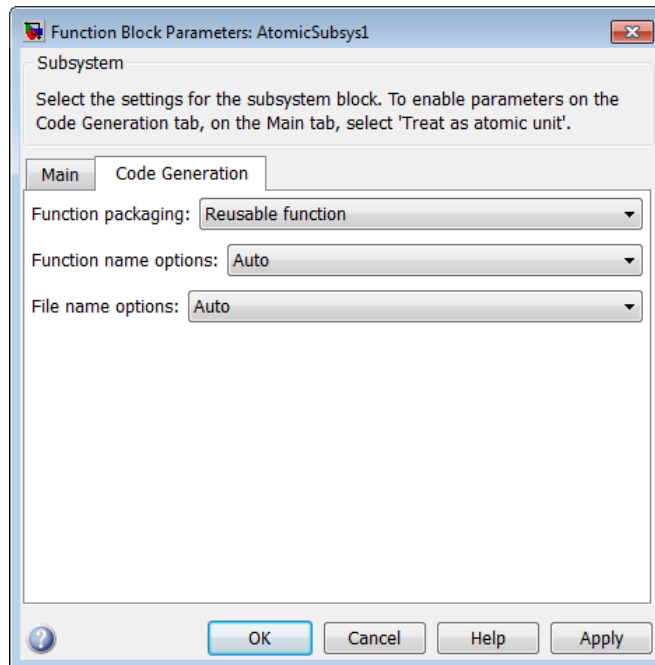

For more information about this setting, see “Considerations for **Function Packaging** Options Auto and Reusable function” on page 2-13.

- 4 Set the function name using the “Function name options” parameter.

---

**Note** If you do not choose Auto, for all other Subsystem blocks that you want to share this code, specify the same function name for those Subsystem blocks.

---

- 5 Set the file name using the “File name options” parameter to a value other than Auto. If your generated code is under source control, a value other than Auto prevents the generated file name from changing due to unrelated model modifications.



---

**Note** For all other Subsystem blocks that you want to share this code, specify the same file name for those Subsystem blocks.

---

6 Click **Apply** and close the dialog box.

For a summary of code reuse limitations, see “Code Reuse Limitations for Subsystems” on page 2-17.

## **Considerations for Function Packaging Options Auto and Reusable function**

When you want multiple instances of a subsystem to be represented as one reusable function, you can designate each one of them as **Auto** or as **Reusable function**. Use one or the other, because using both creates two reusable functions, one for each specification. The outcomes of these choices differ only when reuse is not possible. Selecting **Auto** does not allow control of the function or file name for the subsystem code.

The **Reusable function** and **Auto** options both try to determine if multiple instances of a subsystem exist and if the code can be reused. When reuse is not possible, there are differences in the options behavior:

- **Auto** yields inlined code. If circumstances prohibit inline, then the generated code is separate functions without arguments for each subsystem instance.
- **Reusable function** yields a separate function with arguments for each subsystem instance in the model.

## Optimize Code for Identical Nested Subsystems

The **Function packaging** parameter **Auto** option can optimize code in situations in which identical subsystems contain other identical subsystems, by both reusing and inlining generated code. Suppose a model, such as the one shown in Reuse of Identical Nested Subsystems on page 2-14, contains identical subsystems A1 and A2. A1 contains subsystem B1, and A2 contains subsystem B2, which are identical. In such cases, the **Auto** option causes one function to be generated which is called for both A1 and A2. This function contains one piece of inlined code to execute B1 and B2. This optimization generates less code which improves execution speed.

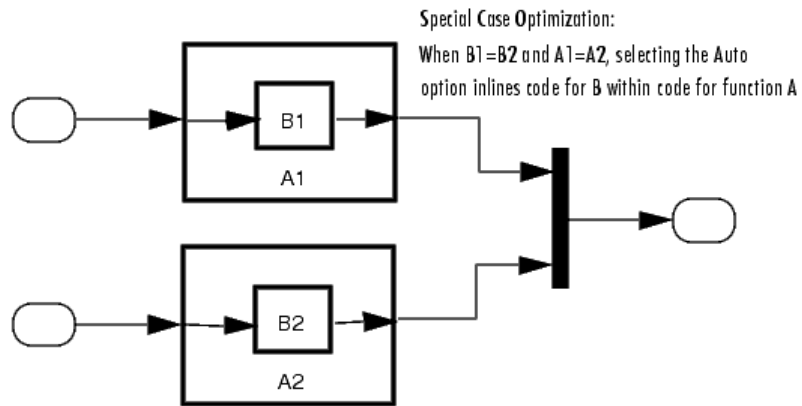

**Reuse of Identical Nested Subsystems**

## Generate Reusable Code for Subsystems Containing S-Function Blocks

There are several requirements that need to be met in order for subsystems containing S-function blocks to be reused. For the list of requirements, see “S-Functions That Support Code Reuse” on page 14-113.

When you select the `Reusable` function option, two additional options are enabled, **Function name options** and **File name options**. If you use these fields to enter a function name and/or a file name, you must specify exactly the same function name and file name for each instance of identical subsystems for the code generator to reuse the subsystem code. For an example, follow the procedure in “Generate Reusable Function for Identical Subsystems Within a Model” on page 2-11.

### **Generate Reusable Code from Stateflow Charts**

You can generate reusable code from a Stateflow chart, or from a subsystem containing a chart, *except* in the following cases:

- The Stateflow chart contains exported graphical functions.
- The Stateflow model contains machine parented events.

## Code Reuse Limitations for Subsystems

The code generator uses a checksum to determine whether subsystems are identical and reusable. Subsystem code is not reused, if:

- Multiple ports of a subsystem share the same source.
- A port used by multiple instances of a subsystem has different sample times, data types, complexity, frame status, or dimensions across the instances.
- The output of a subsystem is marked as a global signal.
- Subsystems contain identical blocks with different names or parameter settings.
- The output of a subsystem is connected to a Merge block, and the output of the Merge block is a custom storage class that is implemented in the C code as memory that is nonaddressable (for example, `BitField`).
- The input of a subsystem is nonscalar and has a custom storage class that is implemented in the C code as memory that is nonaddressable.
- A masked subsystem has a parameter that is nonscalar and has a custom storage class that is implemented in the C code as memory that is nonaddressable.

If you select `Reusable` function, and the code generator determines that code for a subsystem cannot be reused, it generates a separate function that is not reused. The code generation report might show that the separate function is reusable, even if it is used by only one subsystem. If you prefer that subsystem code be inlined in such circumstances rather than deployed as functions, then choose `Auto` for the **Function packaging** option.

### Blocks That Prevent Code Reuse

Use of the following blocks in a subsystem can also prevent the subsystem code from being reused:

- Scope blocks (with data logging enabled)
- S-Function blocks that fail to meet certain criteria (see “S-Functions That Support Code Reuse” on page 14-113)

- To File blocks (with data logging enabled)
- To Workspace blocks (with data logging enabled)

## **Code Reuse Limitations for Subsystems Shared Across Referenced Models**

The code generator uses a checksum to determine whether reusable library subsystems are identical. The reusable library subsystem code is placed in the shared utilities folder and is independent of the generated code of the top model or the referenced model. For example, the reusable library subsystem code does not include *model.h* or *model\_types.h*.

Reusable code that is generated to the shared utilities folder and is dependent on the model code does not compile. If the code generator determines that the reusable library subsystem code is dependent on the model code, the reusable subsystem code is not generated to the shared utilities folder. The following cases might generate code that is dependent on the model code, when the reusable library subsystem:

- Contains a block that uses time-related functionality, such as a Step block, or continuous time or multirate blocks.
- Contains one or more Model blocks.
- Contains subsystems that are not inlined or a reusable library subsystem.
- Contains a For Each subsystem and the model configuration parameter, **Inline parameters**, is cleared. In this case, types are defined in *model\_types.h*.
- Contains a signal that is not an Auto storage class. Variables of non-Auto storage classes are generated to *model.h*.
- Contains a parameter that is not an Auto storage class.
- Contains a user-defined type where **Data Scope** is not set to Exported. The code generator might place the type definition in *model\_types.h*.
- Is a variant subsystem that generates preprocessor conditionals. Preprocessor directives defining the variant objects are included in *model\_types.h*.

## Code Reuse For Subsystems Shared Across Referenced Models

To reuse common functionality, you can include multiple instances of a subsystem within a model and across referenced models. To generate a reusable function for a subsystem which is included in multiple referenced models:

- If the subsystem is in a model reference hierarchy, set the configuration parameter, **Shared code placement** to Auto. Otherwise, for each model that uses the subsystem, set **Shared code placement** to Shared location. The **Shared code placement** parameter is in the Configuration Parameters dialog box, on the **Code Generation > Interface** pane.
- The subsystem must be defined in a library and configured for reuse. This subsystem is referred to as a *reusable library subsystem*. For more information, see “Reusable Library Subsystem” on page 2-20.

For an example, see “Generate Reusable Code for Subsystems Shared Across Models” on page 2-25.

The code generator performs a checksum to determine reusability. There are cases when the code generator cannot reuse subsystem code. For more information, see “Code Reuse Limitations for Subsystems” on page 2-17.

## Reusable Library Subsystem

A reusable library subsystem is a subsystem included in a library that is configured for reuse. The Subsystem parameters must be set as follows:

- **Treat as an atomic unit** is selected.
- On the **Code Generation** tab:
  - **Function packaging** is set to `Reusable` function.
  - **Function name options**  
and **File name options** are set to `Auto` or `Use subsystem name`.

For more information on creating a library, see “Libraries”. For an example of creating a reusable library subsystem, see “Generate Reusable Code for Subsystems Shared Across Models” on page 2-25.

### Code Generation of a Reusable Library Subsystem

For incremental code generation, if the reusable library subsystem changes, a rebuild of itself and its parents occurs. During the build, if a matching function is not found, a new instance of the reusable function is generated into the shared utilities folder. If a different matching function is found from previous builds, that function is used, and a new reusable function is not emitted.

For subsequent builds, unused files are not replaced or deleted from your folder. During development of a model, when many obsolete shared functions exist in the shared utilities folder, you can delete the folder and regenerate the code. If all instances of a reusable library subsystem are removed from a model reference hierarchy and you regenerate the code, the obsolete shared functions remain in the shared utilities folder until you delete them.

If a model changes such that the change might cause different generated code for the subsystem, a new reusable function is generated. For example, model configuration parameters that modify code comments might cause different generated code for the subsystem even if the reusable library subsystem did not change.



## Reusable Library Subsystem Code Placement and Naming

The code generator uses checksums to determine reusability. The generated code of a reusable library subsystem is independent of the generated code of the model. Code for the reusable library subsystem is generated to the shared utility folder, `slprj/target/_sharedutils`, instead of the model reference hierarchy folders. The generated code for the supporting types, which are generated to the `.h` file, are also in the shared utilities folder.

In the Subsystem Parameters dialog box, the **Function name options** and **File name options** must be set to Auto or Use subsystem name. For unique naming, reusable function names have a checksum string appended to the reusable library subsystem name. For example, the code and files for a subsystem, `SS1`, which links to a reusable library subsystem, `RLS`, might be:

- Function name: `RLS_mgdj1ngd`
- File name: `RLS_mgdj1nd.c` and `RLS_mgdj1nd.h`

## Reusable Library Subsystem in the Top Model

In a model reference hierarchy, if an instance of the reusable library subsystem is in the top model, then on the **Model Referencing** pane of the Configuration Parameters dialog box, you must select the **Pass fixed-size scalar root input by value for code generation** parameter. If you do not select the parameter, a separate shared function is generated for the reusable library subsystem instance in the top model, and a reusable function is generated for instances in the referenced models.

## Reusable Library Subsystem Connected to Root Output

If a reusable library subsystem is connected to the root output, reuse does not happen with identical subsystems that are not connected to the root output. However, you can set **Pass reusable system outputs as** to Individual arguments on the **Optimizations > Signals and Parameters** pane to make sure that reuse occurs between these subsystems. This parameter requires an Embedded Coder license.

## Code Generation of Constant Parameters

The code generator attempts to generate constant parameters to the shared utilities folder first. If constant parameters are not generated to the shared utilities folder, they are defined in the top model in a global constant parameter structure. The declaration of the structure, `ConstParam_model`, is in `model.h`:

```
/* Constant parameters (auto storage) */
typedef struct {
    /* Expression: [1 2 3 4 5 6 7]
     * Referenced by: '<Root>/Constant'
     */
    real_T Constant_Value[7];

    /* Expression: [7 6 5 4 3 2 1]
     * Referenced by: '<Root>/Gain'
     */
    real_T Gain_Gain[7];
} ConstParam_model;
```

The definition of the constant parameters, `model_constP`, is in:

```
/* Constant parameters (auto storage) */
const ConstParam_model model_ConstP = {
    /* Expression: [1 2 3 4 5 6 7]
     * Referenced by: '<Root>/Constant'
     */
    { 1.0, 2.0, 3.0, 4.0, 5.0, 6.0, 7.0 },

    /* Expression: [7 6 5 4 3 2 1]
     * Referenced by: '<Root>/Gain'
     */
    { 7.0, 6.0, 5.0, 4.0, 3.0, 2.0, 1.0 }
};
```

The `model_constP` is passed as an argument to referenced models. For more information on how shared constants are generated, see “Shared Constant Parameters for Code Reuse” on page 2-23.

## Shared Constant Parameters for Code Reuse

You can share the generated code for constant parameters across models if:

- Constant parameters are shared in a model reference hierarchy, or
- On the **Code Generation > Interface** pane, the model configuration parameter **Shared code placement** is set to **Shared location**.

The shared constant parameters are generated individually to the `const_params.c` file, which is placed in the shared utilities folder `slprj/target/_sharedutils`.

For example, if a constant has multiple uses within a model reference hierarchy where the top model is named `topmod`, the code for the shared constant is as follows:

- In the shared utility folder, `slprj/grt/_sharedutils`, the constant parameters are defined in `const_params.c` and named `rtCP_pooled_` appended to a unique checksum string:

```
extern const real_T rtCP_pooled_lfcjjmohiecj[7];
const real_T rtCP_pooled_lfcjjmohiecj[7] = { 1.0, 2.0, 3.0, 4.0, 5.0, 6.0, 7.0 };

extern const real_T rtCP_pooled_ppphohdbfcba[7];
const real_T rtCP_pooled_ppphohdbfcba[7] = { 7.0, 6.0, 5.0, 4.0, 3.0, 2.0, 1.0 };
```

- In `top_model_private.h` or in any referenced model, `ref_model_private.h`, for better readability, the constants are renamed as follows:

```
extern const real_T rtCP_pooled_lfcjjmohiecj[7];
extern const real_T rtCP_pooled_ppphohdbfcba[7];

#define rtCP_Constant_Value    rtCP_pooled_lfcjjmohiecj /* Expression: [1 2 3 4 5 6 7]
                                     * Referenced by: '<Root>/Constant' */
#define rtCP_Gain_Gain        rtCP_pooled_ppphohdbfcba /* Expression: [7 6 5 4 3 2 1]
                                     * Referenced by: '<Root>/Gain' */
```

- In `topmod.c` or `refmod.c`, the call site might be:

```
for (i = 0; i < 7; i++) {  
    topmod_Y.Out1[i] = (topmod_U.In1 + rtCP_Constant_Value[i]) * rtCP_Gain_Gain[i];  
}
```

The code generator attempts to generate all constants as individual constants to the `const_params.c` file in the shared utilities folder. Otherwise, constants are generated as described in “Code Generation of Constant Parameters” on page 2-22.

### Shared Constant Parameters Limitations

No shared constants or shared functions are generated for a model when:

- The model has a Code Replacement Library (CRL) that is specified for data alignment.
- The model is specified to replace data type names in the generated code.
- The **Memory Section** for constants is `MemVolatile` or `MemConstVolatile`.

Individual constants are not shared, if:

- A constant is referenced by a non-inlined S-function.
- A constant has a user-defined type where **Data Scope** is not set to `Exported`.

## Generate Reusable Code for Subsystems Shared Across Models

This example shows you how to configure a reusable library subsystem and generate a reusable function for a subsystem shared across referenced models. The result is reusable code for the subsystem, which is generated to the shared utility folder (`slprj/target/_sharedutils`). For more information about a reusable library subsystem, see “Code Reuse For Subsystems Shared Across Referenced Models” on page 2-19.

### Create a reusable library subsystem.

- 1 In the Simulink Editor, select **File > New > Library**. Open `rtwdemo_ssreuse` to copy and paste subsystem `SS1` into the Library Editor. This action loads the variables for `SS1` into the base workspace. Rename the subsystem block to `RLS`.

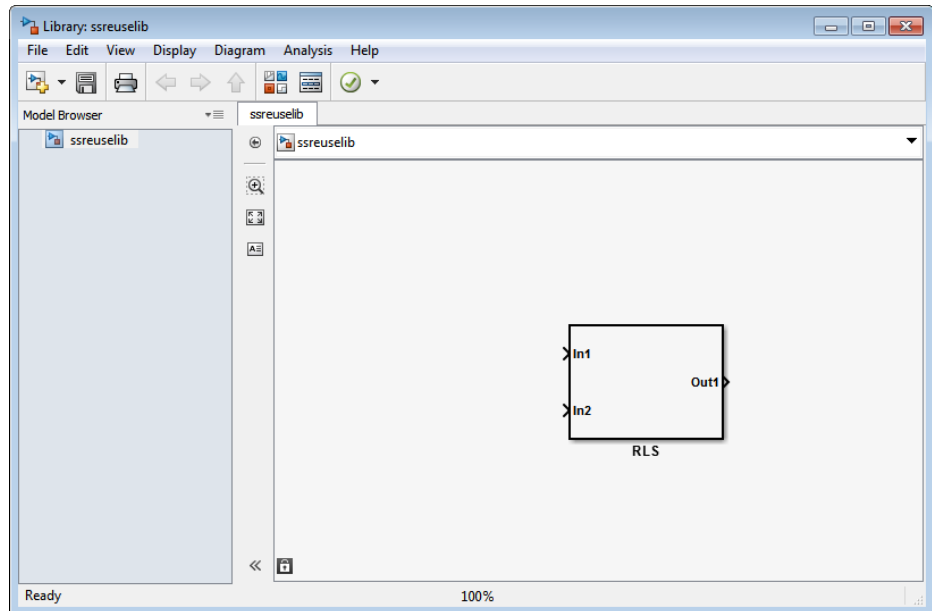

- 2 Click the Subsystem block and press **Ctrl+U** to view the contents of subsystem `RLS`.

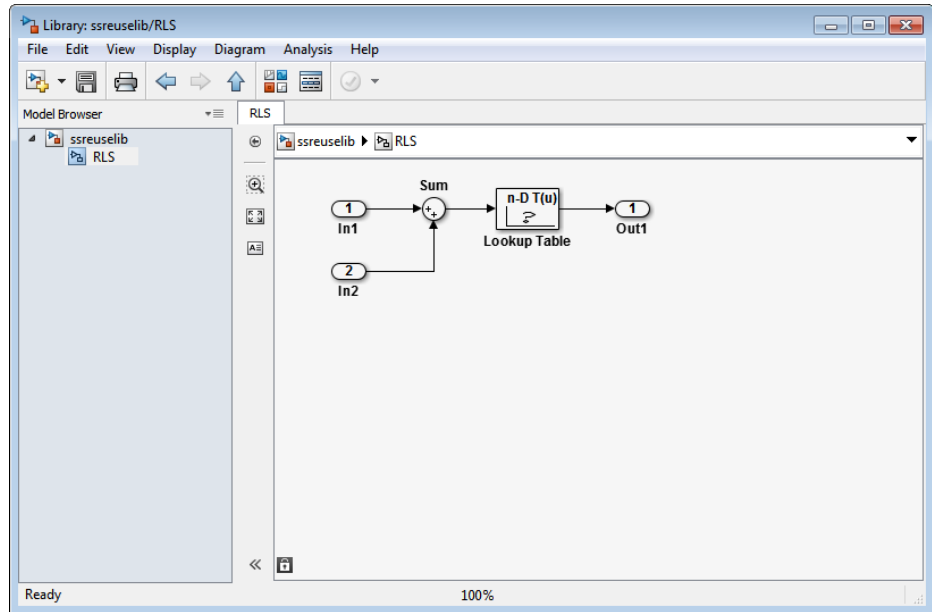

**3** To configure the subsystem, in the Library editor, right-click RLS. In the context menu, select **Block Parameters(Subsystem)**. In the Subsystem Parameters dialog box, choose the following options:

- Select **Treat as an atomic unit**.
- On the **Code Generation** tab:
  - Set **Function packaging** to Reusable function.
  - Set **Function name options** and **File name options** to Auto.

**4** Click **Apply** and **OK**.

**5** Save the reusable library subsystem as `ssreuselib`, which creates a file, `ssreuselib.slx`.

### Create the example model.

**1** Create a model which includes one instance of RLS from `ssreuselib`. Name this subsystem `SS1`. Add another subsystem and name it `SS2`. Name the model `ex_model1`.

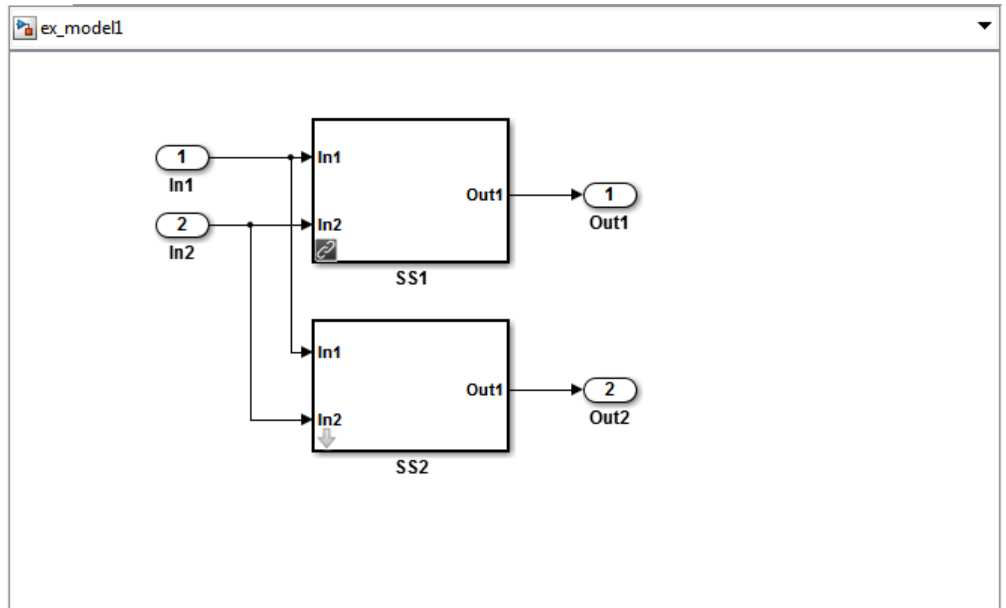

- 2 Create another model which includes one instance of RLS from `ssreuselib`. Name this subsystem SS1. Add another subsystem and name it SS3. Name the model `ex_model12`.

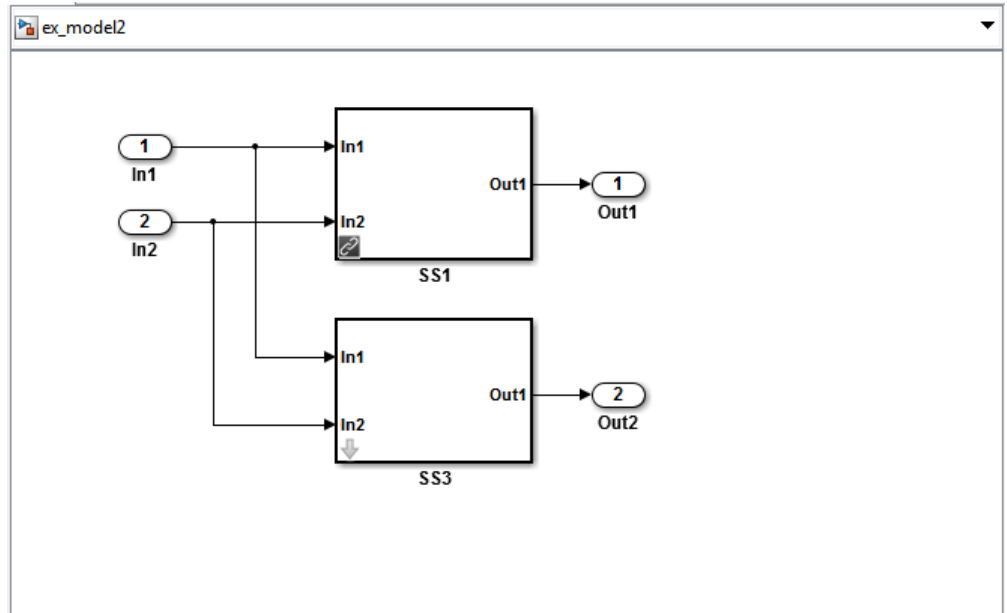

- 3** Create a top model with two model blocks that reference ex\_model1 and ex\_model2. Save the top model as ex\_md1ref\_ssreuse.

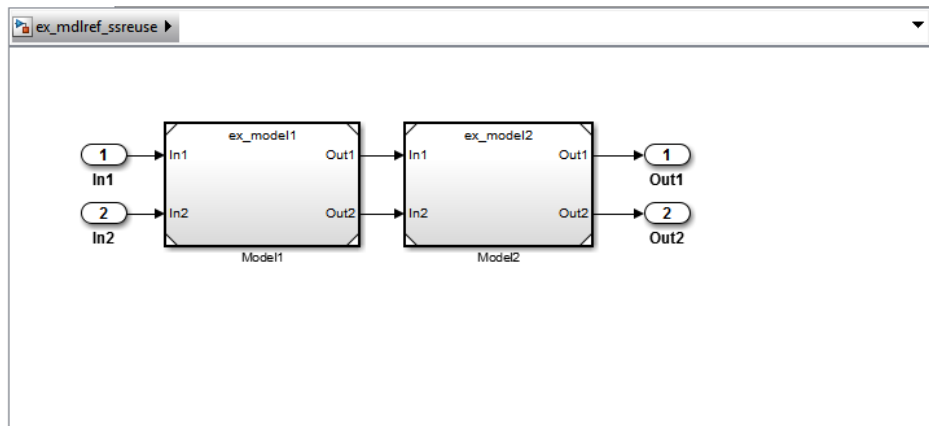

**Set configuration parameters of the top model.**



- 1 With model `ex_md1ref_ssreuse` open in the Simulink Editor, select **Simulation > Model Configuration Parameters** to open the Configuration Parameters dialog box.
- 2 On the **Optimization > Signals and Parameters** pane, select **Inline parameters**.
- 3 On the **Solver** pane, specify the **Type** as `Fixed-step`.
- 4 On the **Code Generation > Report** pane, select **Create code generation report** and **Open report automatically**.
- 5 On the **Code Generation > Interface** pane, set the **Shared code placement** to `Shared location`.
- 6 On the **Code Generation > Symbols** pane, set the **Maximum identifier length** to 256. This step is optional.
- 7 Click **Apply** and **OK**.

#### **Create and propagate a configuration reference.**

- 1 In the Simulink Editor, select **View > Model Explorer** to open the Model Explorer. In the left navigation column of the Model Explorer, expand the `ex_md1ref_ssreuse` node.
- 2 Right-click **Configuration** and select **Convert to Configuration Reference**.
- 3 In the **Convert Active Configuration to Reference** dialog box, click **OK**. This action converts the model configuration set to a configuration reference, `Simulink.ConfigSetRef`, and creates the configuration reference object, `configSetObj`, in the base workspace.
- 4 In the left navigation column, right-click **Reference (Active)** and select **Propagate to Referenced Models**.
- 5 In the **Configuration Reference Propagation to Referenced Models** dialog box, select the referenced models in the list. Click **Propagate**.

Now, the top model and reference models all use the same configuration reference, `Reference (Active)`, which points to a model configuration

reference object, `configSetObj`, in the base workspace. When you save your model, you also need to export the `configSetObj` to a MAT-file. For more information, see “Save a Referenced Configuration Set”.

### Generate and view the code.

- 1 To generate code, in the Simulink Editor, press **Ctrl-B**. After the code is generated, the code generation report opens.
- 2 To view the code generation report for a referenced model, in the left navigation pane, in the **Referenced Models** section, select `ex_model1`. The code generation report displays the generated files for `ex_model1`.
- 3 In the left navigation pane, expand the **Shared Utility files**. The code generator uses the reusable library subsystem name and a unique string to name the reused function. The code for subsystem SS1 is in `RLS_aaaippph.c` and `RLS_aaaippph.h`.

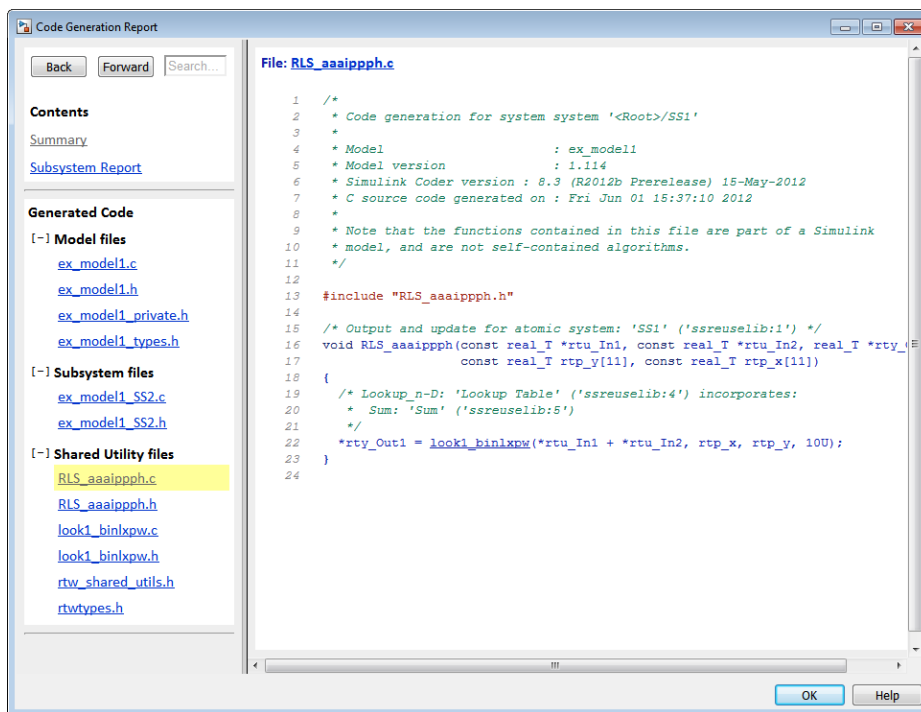

The screenshot shows the 'Code Generation Report' window. On the left, the 'Contents' pane is expanded to 'Shared Utility files', where 'RLS\_aaaippph.c' is highlighted. The main pane displays the C code for 'File: RLS\_aaaippph.c'.

```

1  /*
2  * Code generation for system system '<Root>/SS1'
3  *
4  * Model                : ex_model1
5  * Model version        : 1.114
6  * Simulink Coder version : 8.3 (R2012b Prerelease) 15-May-2012
7  * C source code generated on : Fri Jun 01 15:37:10 2012
8  *
9  * Note that the functions contained in this file are part of a Simulink
10 * model, and are not self-contained algorithms.
11 */
12
13 #include "RLS_aaaippph.h"
14
15 /* Output and update for atomic system: 'SS1' ('ssreuselib:1') */
16 void RLS_aaaippph(const real_T *rtu_In1, const real_T *rtu_In2, real_T *rtu_Out1,
17                  const real_T rtp_y[11], const real_T rtp_x[11])
18 {
19     /* Lookup_n-D: 'Lookup Table' ('ssreuselib:4') incorporates:
20      * Sum: 'Sum' ('ssreuselib:5')
21      */
22     *rtu_Out1 = look1_binlpxw(*rtu_In1 + *rtu_In2, rtp_x, rtp_y, 10U);
23 }
24
  
```

- 4 Click **Back** and navigate to the `ex_model2` code generation report. `ex_model2` uses the same source code, `RLS_aaaipph.c` and `RLS_aaaipph.h`, as the code for `ex_model1`. Your subsystem function and file names will be different.

## Related Examples

- “Determine Why Subsystem Code Is Not Reused” on page 2-32
- “Share a Configuration Across Referenced Models”
- “Generate Reusable Function for Identical Subsystems Within a Model” on page 2-11

## Concepts

- “Code Generation of Subsystems” on page 2-2
- “Code Reuse For Subsystems Shared Across Referenced Models” on page 2-19
- “Code Reuse Limitations for Subsystems” on page 2-17
- “Libraries”

## Determine Why Subsystem Code Is Not Reused

Due to the limitations described in “Code Reuse Limitations for Subsystems” on page 2-17, the code generator might not reuse generated code as you expect. To determine why code generated for a subsystem is not reused, see “Review the Subsystems Section of the HTML Code Generation Report” on page 2-32. If you cannot determine why based on the report, see “Compare Subsystem Checksum Data” on page 2-32.

### Review the Subsystems Section of the HTML Code Generation Report

If you determine that the code generator does not generate code for a subsystem as reusable code, and you specified the subsystem as reusable, examine the Subsystems section of the HTML code generation report (see “Generate a Code Generation Report” on page 11-5). The Subsystems section contains:

- A table that summarizes how nonvirtual subsystems were converted to generated code.
- Diagnostic information that describes why the contents of some subsystems were not generated as reusable code.

The Subsystems section also indicates the mapping of each noninlined subsystem in the model to functions or reused functions in the generated code. For an example, open and build the `rtwdemo_atomic` model.

### Compare Subsystem Checksum Data

You can determine why subsystem code is not reused by accessing and comparing subsystem checksum data. The code generator determines whether subsystems are identical by comparing subsystem checksums, as noted in “Code Reuse Limitations for Subsystems” on page 2-17. For subsystem reuse across referenced models, this procedure might not catch every difference.

Consider the model, `rtwdemo_ssreuse`. `SS1` and `SS2` are instances of the same subsystem. In both instances the subsystem parameter **Function packaging** is set to `Reusable function`.

Use the method, `Simulink.SubSystem.getChecksum`, to get the checksum for a subsystem. Compare the results to determine why code is not reused.

- 1 Open the model `rtwdemo_ssreuse`. Save a copy of the model in a folder where you have write access.
- 2 In the model window, select subsystem `SS1`. In the command window, enter
 

```
SS1 = gcb;
```
- 3 In the model window, select subsystem `SS2`. In the command window, enter
 

```
SS2 = gcb;
```
- 4 Use the method, `Simulink.SubSystem.getChecksum`, to get the checksum for each subsystem. This method returns two output values: the checksum value and details on the input used to compute the checksum.

```
[chksum1, chksum1_details] = ...
Simulink.SubSystem.getChecksum(SS1);
[chksum2, chksum2_details] = ...
Simulink.SubSystem.getChecksum(SS2);
```

- 5 Compare the two checksum values. They should be equal based on the subsystem configurations.

```
isequal(chksum1, chksum2)
ans =
     1
```

- 6 To see how you can use `Simulink.SubSystem.getChecksum` to determine why the checksums of two subsystems differ, change the data type mode of the output port of `SS1` so that it differs from that of `SS2`.
  - a Look under the mask of `SS1`. Right-click the subsystem. In the context menu, select **Mask > Look Under Mask**.
  - b In the block diagram of the subsystem, double-click the Lookup Table block to open the Subsystem Parameters dialog box.
  - c Click **Data Types**.

**d** Select **Saturate on integer overflow** and click **OK**.

- 7** Get the checksum for SS1. Compare the checksums for the two subsystems. This time, the checksums are not equal.

```
[chksum1, chksum1_details] = ...
Simulink.SubSystem.getChecksum(SS1);
isequal(chksum1, chksum2)
ans =
    0
```

- 8** After you determine that the checksums are different, find out why. The Simulink engine uses information, such as signal data types, some block parameter values, and block connectivity information, to compute the checksums. To determine why checksums are different, you compare the data used to compute the checksum values. You can get this information from the second value returned by `Simulink.SubSystem.getChecksum`, which is a structure array with four fields.

Look at the structure `chksum1_details`.

```
chksum1_details

chksum1_details =
    ContentsChecksum: [1x1 struct]
    InterfaceChecksum: [1x1 struct]
    ContentsChecksumItems: [287x1 struct]
    InterfaceChecksumItems: [53x1 struct]
```

`ContentsChecksum` and `InterfaceChecksum` are component checksums of the subsystem checksum. The remaining two fields, `ContentsChecksumItems` and `InterfaceChecksumItems`, contain the checksum details.

- 9** Determine whether a difference exists in the subsystem contents, interface, or both. For example:

```
isequal(chksum1_details.ContentsChecksum.Value, ...
        chksum2_details.ContentsChecksum.Value)
ans =
    0
```

```
isequal(chksum1_details.InterfaceChecksum.Value,...
        chksum2_details.InterfaceChecksum.Value)
ans =
    1
```

In this case, differences exist in the contents.

**10** Write a script like the following to find the differences.

```
idxForCDiffs=[];
for idx = 1:length(chksum1_details.ContentsChecksumItems)
    if (~strcmp(chksum1_details.ContentsChecksumItems(idx).Identifier, ...
               chksum2_details.ContentsChecksumItems(idx).Identifier))
        disp(['Identifiers different for contents item ', num2str(idx)]);
        idxForCDiffs=[idxForCDiffs, idx];
    end
    if (ischar(chksum1_details.ContentsChecksumItems(idx).Value))
        if (~strcmp(chksum1_details.ContentsChecksumItems(idx).Value, ...
                   chksum2_details.ContentsChecksumItems(idx).Value))
            disp(['String values different for contents item ', num2str(idx)]);
            idxForCDiffs=[idxForCDiffs, idx];
        end
    end
    if (isnumeric(chksum1_details.ContentsChecksumItems(idx).Value))
        if (chksum1_details.ContentsChecksumItems(idx).Value ~= ...
           chksum2_details.ContentsChecksumItems(idx).Value)
            disp(['Numeric values different for contents item ', num2str(idx)]);
            idxForCDiffs=[idxForCDiffs, idx];
        end
    end
end
end
```

**11** Run the script. The following example assumes that you named the script `check_details`.

```
check_details
String values different for contents item 202
```

The results indicate that differences exist for index item 202 in the subsystem contents.

- 12** Use the returned index values to get the handle, identifier, and value details for each difference found.

```
chksum1_details.ContentsChecksumItems(202)
```

```
ans =
```

```
        Handle: 'rtwdemo_ssreuse/SS1/Lookup Table'  
    Identifier: 'SaturateOnIntegerOverflow'  
        Value: 'on'
```

The details identify the Lookup Table block parameter **Saturate on integer overflow** as the focus for debugging a subsystem reuse issue.



# Referenced Models

---

## Code Generation for Referenced Models

This section describes model referencing considerations that apply specifically to code generation by the Simulink Coder. This section assumes that you understand referenced models and related terminology and requirements, as described in “Overview of Model Referencing” and associated topics.

When generating code for a referenced model hierarchy, the code generator produces a stand-alone executable for the top model, and a library module called a *model reference target* for each referenced model. When the code executes, the top executable invokes the model reference targets to compute the referenced model outputs. Model reference targets are sometimes called *Simulink Coder targets*.

Be careful not to confuse a model reference target (Simulink Coder target) with any of these other types of targets:

- **Hardware target** — A platform for which the Simulink Coder software generates code
- **System target** — A file that tells the Simulink Coder software how to generate code for particular purpose
- **Rapid Simulation target (RSim)** — A system target file supplied with the Simulink Coder product
- **Simulation target** — A MEX-file that implements a referenced model that executes with Simulink Accelerator™ software

The code generator places the code for the top model of a hierarchy in the current working folder, and the code for submodels in a folder named `s1prj` within the current working folder. Subfolders in `s1prj` provide separate places for different types of files. See “Project Folder Structure for Model Reference Targets” on page 3-16 for details.

By default, the product uses *incremental code generation*. When generating code, it compares structural checksums of referenced model files with the generated code files to determine whether to regenerate model reference targets. To control when rebuilds occur, use the configuration parameter **Model Referencing > Rebuild**. For details, see “Rebuild”.

In addition to incremental code generation, the Simulink Coder software uses *incremental loading*. The code for a referenced model is not loaded into memory until the code for its parent model executes and needs the outputs of the referenced model. The product then loads the referenced model target and executes. Once loaded, the target remains in memory until it is no longer used.

Most code generation considerations are the same whether or not a model includes any referenced models: the code generator handles the details automatically insofar as possible. This chapter describes topics that you may need to consider when generating code for a model reference hierarchy.

If you have an Embedded Coder license, custom targets must declare themselves to be model reference compliant if they need to support Model blocks. For more information, see “Support Model Referencing” on page 24-101.

## Generate Code for Referenced Models

In this section...
“About Generating Code for Referenced Models” on page 3-4
“Create and Configure the Subsystem” on page 3-4
“Convert Model to Use Model Referencing” on page 3-7
“Generate Model Reference Code for a GRT Target” on page 3-11
“Work with Project Folders” on page 3-14

### About Generating Code for Referenced Models

To generate code for referenced models, you

- 1 Create a subsystem in an existing model.
- 2 Convert the subsystem to a referenced model (Model block).
- 3 Call the referenced model from the top model.
- 4 Generate code for the top model and referenced model.
- 5 Explore the generated code and the project folder.

You can accomplish some of these tasks automatically with a function called `Simulink.Subsystem.convertToModelReference`.

### Create and Configure the Subsystem

In the first part of this example, you define a subsystem for the `vdp` example model, set configuration parameters for the model, and use the `Simulink.Subsystem.convertToModelReference` function to convert it into two new models — the top model (`vdptop`) and a referenced model `vdpmultRM` containing a subsystem you created (`vdpmult`).

- 1 In the MATLAB Command Window, create a new working folder wherever you want to work and cd into it:

```
mkdir mrexample
cd mrexample
```

- 2 Open the vdp example model by typing:

```
vdp
```

- 3 Drag a box around the three blocks outlined in blue below:

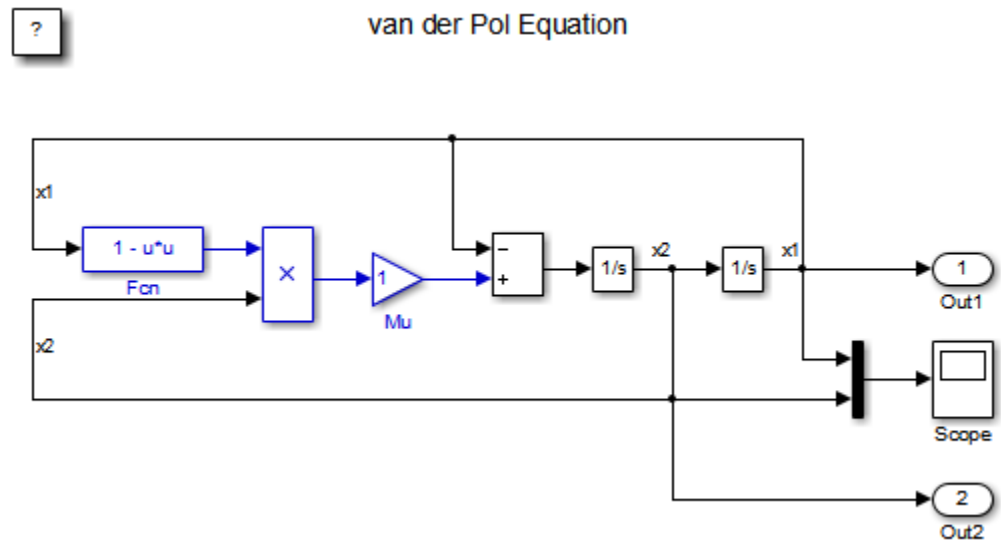

- 4 Choose **Create Subsystem from Selected** from the model's **Diagram > Subsystem & Model Reference** menu.

A subsystem block replaces the selected blocks.

- 5 If the new subsystem block is not where you want it, move it to a preferred location.
- 6 Rename the block vdpmult.

7 Right-click the vdpmult block and select **Subsystem Parameters**.

The **Function Block Parameters** dialog box appears.

8 In the **Function Block Parameters** dialog box, select **Treat as atomic unit**, then click **OK**.

The border of the vdpmult subsystem thickens to indicate that it is now atomic. An atomic subsystem executes as a unit relative to the parent model: subsystem block execution does not interleave with parent block execution. This property makes it possible to extract subsystems for use as stand-alone models and as functions in generated code.

The block diagram should now appear as follows:

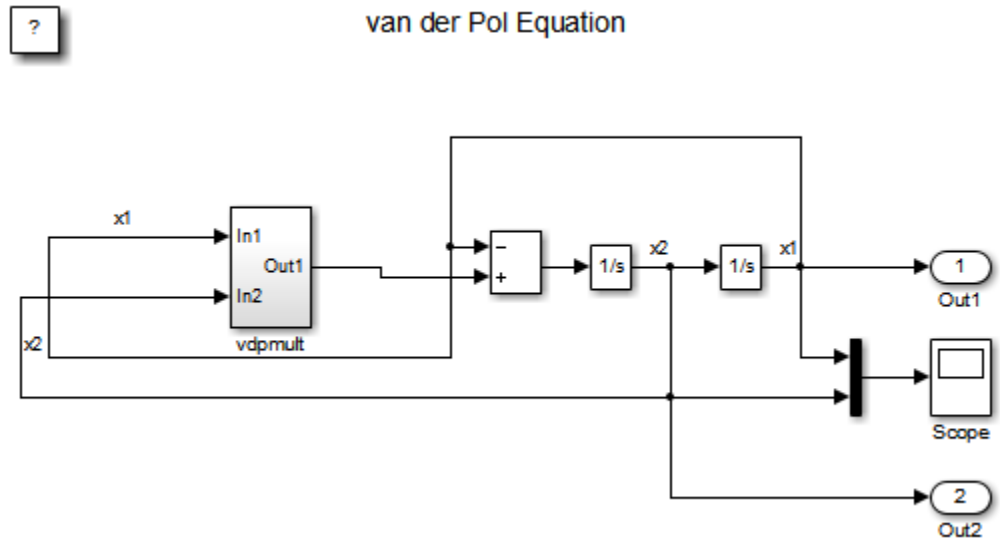

You must set several properties before you can extract a subsystem for use as a referenced model. To set the properties,

1 Open Model Explorer by selecting **Model Explorer** from the model's **View** menu.

- 2** In the **Model Hierarchy** pane, click the symbol preceding the model name to reveal its components.
- 3** Click **Configuration (Active)** in the left pane.
- 4** In the center pane, select **Solver**.
- 5** In the right pane, under **Solver Options** change the **Type** to **Fixed-step**, then click **Apply**. You must use fixed-step solvers when generating code, although referenced models can use different solvers than top models.
- 6** In the center pane, select **Optimization**. In the right pane, select the **Signals and Parameters** tab, and under **Simulation and code generation**, select **Inline parameters**. Click **Apply**.
- 7** In the center pane, select **Diagnostics**. In the right pane:
  - a** Select the **Data Validity** tab. In the **Signals** area, set **Signal resolution** to **Explicit only**.
  - b** Select the **Connectivity** tab. In the **Buses** area, set **Mux blocks used to create bus signals** to **error**.
- 8** Click **Apply**.

The model now has the properties that model referencing requires.
- 9** In the center pane, click **Model Referencing**. In the right pane, set **Rebuild** to **If any changes in known dependencies detected**. Click **Apply**. This setting prevents code regeneration when it is not required.
- 10** In the vdp model window, choose **File > Save as**. Save the model as **vdptop** in your working folder. Leave the model open.

## Convert Model to Use Model Referencing

In this portion of the example, you use the conversion function `Simulink.SubSystem.convertToModelReference` to extract the subsystem `vdpmult` from `vdptop` and convert `vdpmult` into a referenced model named `vdpmultRM`. To see the complete syntax of the conversion function, type at the MATLAB prompt:

```
help Simulink.SubSystem.convertToModelReference
```

For additional information, type:

```
doc Simulink.SubSystem.convertToModelReference
```

If you want to see an example of `Simulink.SubSystem.convertToModelReference` before using it yourself, type:

```
sldemo_mdhref_conversion
```

Simulink also provides a menu command, **Subsystem & Model Reference > Convert Subsystem to > Referenced Model**, that you can use to convert a subsystem to a referenced model. The command calls `Simulink.SubSystem.convertToModelReference` with default arguments. For more information, see “Convert a Subsystem to a Referenced Model”.

### **Extract the Subsystem to a Referenced Model**

To use `Simulink.SubSystem.convertToModelReference` to extract `vdpmult` and convert it to a referenced model, type:

```
Simulink.SubSystem.convertToModelReference...  
( 'vdptop/vdpmult', 'vdpmultRM',...  
'ReplaceSubsystem', true, 'BuildTarget', 'Sim' )
```

This command:

- 1** Extracts the subsystem `vdpmult` from `vdptop`.
- 2** Converts the extracted subsystem to a separate model named `vdpmultRM` and saves the model to the working folder.
- 3** In `vdptop`, replaces the extracted subsystem with a Model block that references `vdpmultRM`.
- 4** Creates a simulation target for `vdptop` and `vdpmultRM`.

The converter prints progress messages and terminates with

```
ans =  
    1
```



The parent model vdptop now looks like this:

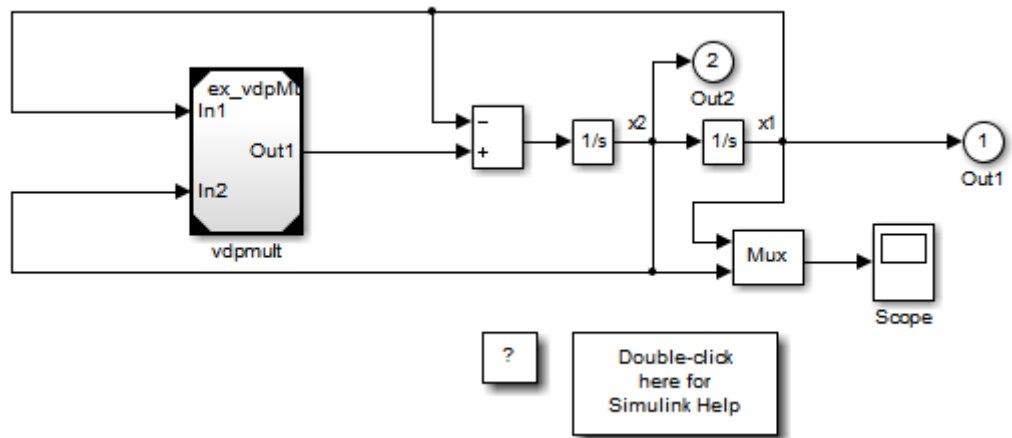

Note the changes in the appearance of the block `vdpmult`. These changes indicate that it is now a Model block rather than a subsystem. As a Model block, it has no contents of its own: the previous contents now exist in the referenced model `vdpmultRM`, whose name appears at the top of the Model block. Widen the Model block to expose the complete name of the referenced model.

If the parent model `vdptop` had been closed at the time of conversion, the converter would have opened it. Extracting a subsystem to a referenced model does *not* automatically create or change a saved copy of the parent model. To preserve the changes to the parent model, save `vdptop`.

Right-click the Model block `vdpmultRM` and choose **Open Model** '`vdpmultRM`' to open the referenced model. The model looks like this:

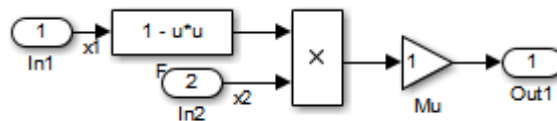

### Files Created and Changed by the Converter

The files in your working folder now consist of the following (not in this order).

File	Description
vdptop model file	Top model that contains a Model block where the vdpmult subsystem was
vdpmultRM model file	Referenced model created for the vdpmult subsystem
vdpmultRM_msf.mexw32	Static library file (Microsoft Windows platforms only). The last three characters of the suffix are system-dependent and may differ. This file executes when the vdptop model calls the Model block vdpmult. When called, vdpmult in turn calls the referenced model vdpmultRM.
/slprj	Project folder for generated model reference code

Code for model reference simulation targets is placed in the `slprj/sim` subfolder. Generated code for GRT, ERT, and other Simulink Coder targets is placed in `slprj` subfolders named for those targets. You will inspect some model reference code later in this example. For more information on project folders, see “Work with Project Folders” on page 3-14.

## Run the Converted Model

Open the Scope block in vdptop if it is not visible. In the vdptop window, click the **Run** tool or choose **Run** from the **Simulation** menu. The model calls the vdpmultRM\_msf simulation target to simulate. The output looks like this:

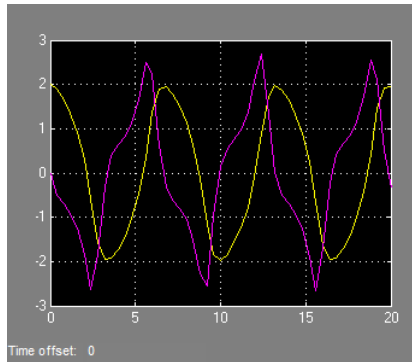

## Generate Model Reference Code for a GRT Target

The function `Simulink.SubSystem.convertToModelReference` created the model and the simulation target files for the referenced model vdpmultRM. In this part of the example, you generate code for that model and the vdptop model, and run the executable you create:

- 1** Verify that you are still working in the `mrexample` folder.
- 2** If the model `vdptop` is not open, open it. Make sure it is the active window.
- 3** Open Model Explorer by selecting **Model Explorer** from the model's **View** menu.
- 4** In the **Model Hierarchy** pane, click the symbol preceding the `vdptop` model to reveal its components.
- 5** Click **Configuration (Active)** in the left pane.
- 6** In the center pane, select **Data Import/Export**.

- 7 In the **Save to workspace** section of the right pane, check **Time** and **Output** and *clear Data stores*. Click **Apply**. The pane shows the following information:

Load from workspace

Input: [tim\_var, data\_var] Edit Input

Initial state: xInitial

Save to workspace

Time, State, Output

Time: tout Format: Array

States: xout  Limit data points to last: 1000

Output: yout Decimation: 1

Final states: xFinal  Save complete SimState in final state

Signals

Signal logging: logout Signal logging format: Dataset

Configure Signals to Log...

Data Store Memory

Data stores: dsmout

Save options

Save simulation output as single object out

Record and inspect simulation output

These settings instruct the model `vdptop` (and later its executable) to log time and output data to MAT-files for each time step.

- 8 Generate GRT code (the default) and an executable for the top model and the referenced model by selecting **Code Generation** in the center pane and then clicking the **Build** button.

The Simulink Coder build process generates and compiles code. The current folder now contains a new file and a new folder:

File	Description
vdptop.exe	The executable created by the build process
vdptop_grt_rtw/	The build folder, containing generated code for the top model

The build process also generated GRT code for the referenced model, and placed it in the slprj folder.

To view a model's generated code in **Model Explorer**, the model must be open. To use the **Model Explorer** to inspect the newly created build folder, vdptop\_grt\_rtw:

- 1** Open Model Explorer by selecting **Model Explorer** from the model's **View** menu.
- 2** In the **Model Hierarchy** pane, click the symbol preceding the model name to reveal its components.
- 3** Click the symbol preceding **Code** for vdptop to reveal its components.
- 4** Directly under **Code** for vdptop, click **This Model**.

A list of generated code files for vdptop appears in the **Contents** pane:

```
rtmodel.h
vdptop.c
vdptop.h
vdptop.mk
vdptop_private.h
vdptop_types.h
```

You can browse code in any of these files by selecting a file of interest in the **Contents** pane.

To open a file in a text editor, click a filename, and then click the hyperlink that appears in the gray area at the top of the **Document** pane. The figure below illustrates viewing code for `vdptop.c`, in a text editor. Your code may differ.

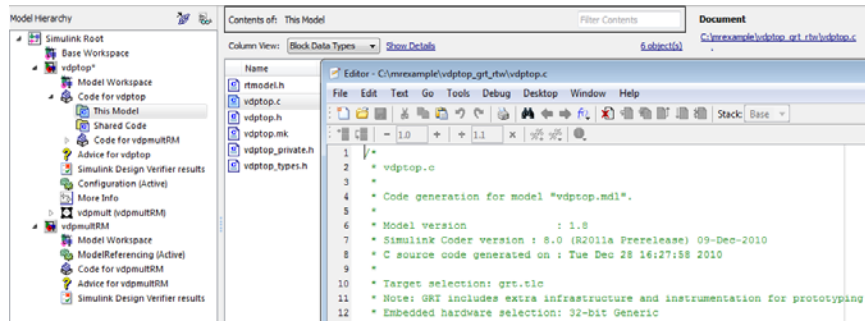

To view the generated code in the HTML code generation report, see “Generate a Code Generation Report” on page 11-5.

## Work with Project Folders

When you view generated code in **Model Explorer**, the files listed in the **Contents** pane can exist either in a build folder or a project folder. Model reference project folders (always rooted under `s1prj`), like build folders, are created in your current working folder, and this implies certain constraints on when and where model reference targets are built, and how they are accessed.

The models referenced by Model blocks can be stored anywhere. A given top model can include models stored on different file systems or in different folders. The same is not true for the simulation targets derived from these models; under most circumstances, all models referenced by a given top model must be set up to simulate and generate model reference target code in a single project folder. The top and referenced models can exist anywhere on your path, but the project folder is assumed to exist in your current folder.

This means that, if you reference the same model from several top models, each stored in a different folder, you must either

- Always work in the same folder and be sure that the models are on your path
- Allow separate project folders, simulation targets, and Simulink Coder targets to be generated in each folder in which you work

The files in such multiple project folders are generally quite redundant. Therefore, to minimize code regeneration for referenced models, choose a specific working folder and remain in it for all sessions.

As model reference code generated for Simulink Coder targets as well as for simulation targets is placed in project folders, the same considerations as above apply even if you are generating target applications only. That is, code for all models referenced from a given model ends up being generated in the same project folder, even if it is generated for different targets and at different times.

## Project Folder Structure for Model Reference Targets

Code for models referenced by using Model blocks is generated in project folders within the current working folder. The top-level project folder is always named `/slprj`. The next level within `slprj` contains parallel build area subfolders.

The following table lists principal project folders and files. In the paths listed, *model* is the name of the model being used as a referenced model, and *target* is the system target file acronym (for example, `grt`, `ert`, `rsim`, and so on).

Folders and Files	Description
<code>slprj/sim/model/</code>	Simulation target files for referenced models
<code>slprj/sim/model/tmwinternal</code>	MAT-files used during code generation
<code>slprj/target/model/referenced_model_includes</code>	Header files from models referenced by this model
<code>slprj/target/model</code>	Model reference target files
<code>slprj/target/model/tmwinternal</code>	MAT-files used during code generation
<code>slprj/sl_proj.tmw</code>	Marker file
<code>slprj/target/_sharedutils</code>	Utility functions for model reference targets, shared across models
<code>slprj/sim/_sharedutils</code>	Utility functions for simulation targets, shared across models

If you are building code for more than one referenced model within the same working folder, model reference files for all such models are added to the existing `slprj` folder.



## Configure Referenced Models

Minimize occurrences of algebraic loops by selecting the **Minimize algebraic loop occurrences** parameter on the **Model Reference** pane. The setting of this option affects only generation of code from the model. See “Hardware Targets” on page 9-9 in the Simulink Coder documentation for information on how this option affects code generation. For more information, see “Model Blocks and Direct Feedthrough”.

Use the **Integer rounding mode** parameter on your model’s blocks to simulate the rounding behavior of the C compiler that you intend to use to compile code generated from the model. This setting appears on the **Signal Attributes** pane of the parameter dialog boxes of blocks that can perform signed integer arithmetic, such as the Product and n-D Lookup Table blocks.

For most blocks, the value of **Integer rounding mode** completely defines rounding behavior. For blocks that support fixed-point data and the Simplest rounding mode, the value of **Signed integer division rounds to** also affects rounding. For details, see “Rounding”.

When models contain Model blocks, all models that they reference must be configured to use identical hardware settings. For information on the **Model Referencing** pane options, see “Model Referencing Pane” and “Configuration Parameter Requirements”.

## Build Model Reference Targets

By default, the Simulink engine rebuilds simulation targets before the Simulink Coder software generates model reference targets. You can change the rebuild criteria or specify that the engine always or never rebuilds targets. See “Rebuild” for details.

The Simulink Coder software generates a model reference target directly from the Simulink model. The product automatically generates or regenerates model reference targets, for example, when they require an update.

You can command the Simulink and Simulink Coder products to generate a simulation target for an Accelerator mode referenced model, and a model reference target for any referenced model, by executing the `slbuild` command with arguments in the MATLAB Command Window.

The Simulink Coder software generates only one model reference target for all instances of a referenced model. See “Reusable Code and Referenced Models” on page 3-32 for details.

## Reduce Change Checking Time

You can reduce the time that the Simulink and Simulink Coder products spend checking whether any or all simulation targets and model reference targets need to be rebuilt by setting configuration parameter values as follows:

- In the top model, consider setting the model configuration parameter **Model Referencing > Rebuild** to **If any changes in known dependencies detected**. (See “Rebuild”.)
- In all referenced models throughout the hierarchy, set the configuration parameter **Diagnostics > Data Validity > Signal resolution** to **Explicit only**. (See “Signal resolution”.)

These parameter values exist in a referenced model’s configuration set, not in the individual Model block, so setting either value for any instance of a referenced model sets it for all instances of that model.

## Simulink Coder Model Referencing Requirements

A model reference hierarchy must satisfy various Simulink Coder requirements, as described in this section. In addition to these requirements, a model referencing hierarchy to be processed by the Simulink Coder software must satisfy:

- The Simulink requirements listed in:
  - “Configuration Requirements for All Referenced Model Simulation”
  - “Model Structure Requirements”
- The Simulink limitations listed in “Limitations on All Model Referencing”
- The Simulink Coder limitations listed in “Simulink® Coder™ Model Referencing Limitations” on page 3-36

### Configuration Parameter Requirements

A referenced model uses a configuration set in the same way that any other model does, as described in “Manage a Configuration Set”. By default, every model in a hierarchy has its own configuration set, which it uses in the same way that it would if the model executed independently.

Because each model can have its own configuration set, configuration parameter values can be different in different models. Furthermore, some parameter values are intrinsically incompatible with model referencing. The response of the Simulink Coder software to an inconsistent or unusable configuration parameter depends on the parameter:

- Where an inconsistency has no significance, or a trivial resolution exists that carries no risk, the product ignores or resolves the inconsistency without posting a warning.
- Where a nontrivial and possibly acceptable solution exists, the product resolves the conflict silently; resolves it with a warning; or generates an error. See “Model configuration mismatch” for details.
- Where no acceptable resolution is possible, the product generates an error. You must then change some or all parameter values to eliminate the problem.

When a model reference hierarchy contains many submodels that have incompatible parameter values, or a changed parameter value must propagate to many submodels, manually eliminating all configuration parameter incompatibilities can be tedious. You can control or eliminate such overhead by using configuration references to assign an externally-stored configuration set to multiple models. See “Manage a Configuration Reference” for details.

The following tables list configuration parameters that can cause problems if set in certain ways, or if set differently in a referenced model than in a parent model. Where possible, the Simulink Coder software resolves violations of these requirements automatically, but most cases require changes to the parameters in some or all models.

**Configuration Requirements for Model Referencing with All System Targets**

<b>Dialog Box Pane</b>	<b>Option</b>	<b>Requirement</b>
<b>Solver</b>	<b>Start time</b>	Some system targets require the start time of all models to be zero.
<b>Hardware Implementation</b>	<b>Emulation hardware options</b>	All values must be the same for top and referenced models.

**Configuration Requirements for Model Referencing with All System Targets (Continued)**

<b>Dialog Box Pane</b>	<b>Option</b>	<b>Requirement</b>	
<b>Code Generation</b>	<b>System target file</b>	Must be the same for top and referenced models.	
	<b>Language</b>	Must be the same for top and referenced models.	
	<b>Generate code only</b>	Must be the same for top and referenced models.	
<b>Symbols</b>	<b>Maximum identifier length</b>	Cannot be longer for a referenced model than for its parent model.	
<b>Interface</b>	<b>Code replacement library</b>	Must be the same for top and referenced models.	
	<b>Data exchange &gt; Interface</b>	<b>C API</b>	The C API check boxes for signals, parameters, and states must be the same for top and referenced models.
		<b>ASAP2</b>	Can be on or off in a top model, but must be off in a referenced

**Configuration Requirements for Model Referencing with All System Targets (Continued)**

Dialog Box Pane	Option	Requirement
		model. If it is not, the Simulink Coder software temporarily sets it to off during code generation.

**Configuration Requirements for Model Referencing with ERT System Targets (Requires Embedded Coder License)**

Dialog Box Pane	Option	Requirement
Code Generation	Ignore custom storage classes	Must be the same for top and referenced models.
Symbols	Global variables Global types Subsystem methods Local temporary variables Constant macros	\$R token must appear.
	Signal naming	Must be the same for top and referenced models.
	M-function	If specified, must be the same for top and referenced models.
	Parameter naming	Must be the same for top and referenced models.
	#define naming	Must be the same for top and referenced models.

### Configuration Requirements for Model Referencing with ERT System Targets (Requires Embedded Coder License) (Continued)

Dialog Box Pane	Option	Requirement
Interface	Support floating-point numbers	Must be the same for both top and referenced models
	Support non-finite numbers	If off for top model, must be off for referenced models.
	Support complex numbers	If off for top model, must be off for referenced models.
	Suppress error status in real-time model	If on for top model, must be on for referenced models.
Templates	Target operating system	Must be the same for top and referenced models.
Data Placement	Module Naming	Must be the same for top and referenced models.
	Module Name (if specified)	If set, must be the same for top and referenced models.
	Signal display level	Must be the same for top and referenced models.
	Parameter tune level	Must be the same for top and referenced models.

### Naming Requirements

Within a model that uses model referencing, there can be no collisions between the names of the constituent models. When you generate code from a model that uses model referencing, the **Maximum identifier length** parameter must be large enough to accommodate the root model name and the name mangling string. A code generation error occurs if **Maximum identifier length** is not large enough.

When a name conflict occurs between a symbol within the scope of a higher-level model and a symbol within the scope of a referenced model, the

symbol from the referenced model is preserved. Name mangling is performed on the symbol from the higher-level model.

### **Embedded Coder Naming Requirements**

The Embedded Coder product provides a **Symbol format** field that lets you control the formatting of generated symbols in much greater detail. When generating code with an ERT target from a model that uses model referencing:

- The **\$R** token must be included in the **Identifier format control** parameter specifications (in addition to the **\$M** token).
- The **Maximum identifier length** must be large enough to accommodate full expansions of the **\$R** and **\$M** tokens.

See “Code Generation Pane: Symbols” for more information.

### **Custom Target Requirements**

If you have an Embedded Coder license, a custom target must meet various requirements to support model referencing. For details, see “Support Model Referencing” on page 24-101.



## Storage Classes for Signals Used with Model Blocks

Models containing Model blocks can use signals of storage class `Auto` without restriction. However, when you declare signals to be global, you must be aware of how the signal data will be handled.

A global signal is a signal with a storage class other than `Auto`:

- `ExportedGlobal`
- `ImportedExtern`
- `ImportedExternPointer`
- `Custom`

The above are distinct from `SimulinkGlobal` signals, which are treated as test points with `Auto` storage class.

Global signals are declared, defined, and used as follows:

- An extern declaration is generated by all models that use any given global signal.  
As a result, if a signal crosses a Model block boundary, the top model and the referenced model both generate extern declarations for the signal.
- For any exported signal, the top mode is responsible for defining (allocating memory for) the signal, whether or not the top model itself uses the signal.
- All global signals used by a referenced model are accessed directly (as global memory). They are not passed as arguments to the functions that are generated for the referenced models.

Custom storage classes also follow the above rules. However, certain custom storage classes are not currently supported for use with model reference. See “Custom Storage Class Limitations” for details.

## Storage Classes for Parameters Used with Model Blocks

All storage classes are supported for both simulation and code generation, and all except `Auto` are tunable. The supported storage classes thus include

- `SimulinkGlobal`
- `ExportedGlobal`
- `ImportedExtern`
- `ImportedExternPointer`
- `Custom`

Note the following restrictions on parameters in referenced models:

- Tunable parameters are not supported for noninlined S-functions.
- Tunable parameters set using the Model Parameter Configuration dialog box are ignored.

Note the following considerations concerning how global tunable parameters are declared, defined, and used in code generated for targets:

- A global tunable parameter is a parameter in the base workspace with a storage class other than `Auto`.
- An `extern` declaration is generated by all models that use any given parameter.
- If a parameter is exported, the top model is responsible for defining (allocating memory for) the parameter (whether it uses the parameter or not).
- All global parameters are accessed directly (as global memory). They are not passed as arguments to any of the functions that are generated for any of the referenced models.
- Symbols for `SimulinkGlobal` parameters in referenced models are generated using unstructured variables (`rtP_xxx`) instead of being written into the `model_P` structure. This is so that each referenced model can be compiled independently.

Certain custom storage classes for parameters are not currently supported for model reference. See “Custom Storage Class Limitations” for details.

Parameters used as Model block arguments must be defined in the referenced model’s workspace. See “Parameterize Model References” in the Simulink documentation for specific details.

## Effects of Signal Name Mismatches

Within a parent model, the name and storage class for a signal entering or leaving a Model block might not match those of the signal attached to the root inport or outport within that referenced model. Because referenced models are compiled independently without regard to any parent model, they cannot adapt to all possible variations in how parent models label and store signals.

The Simulink Coder software accepts all cases where input and output signals in a referenced model have Auto storage class. When such signals are test pointed or are global, as described above, certain restrictions apply. The following table describes how mismatches in signal labels and storage classes between parent and referenced models are handled:

### Relationships of Signals and Storage Classes Between Parent and Referenced Models

Referenced Model	Parent Model	Signal Passing Method	Signal Mismatch Checking
Auto	Any	Function argument	None
SimulinkGlobal or resolved to Signal Object	Any	Function argument	Label Mismatch Diagnostic (none / warning / error)

### Relationships of Signals and Storage Classes Between Parent and Referenced Models (Continued)

Referenced Model	Parent Model	Signal Passing Method	Signal Mismatch Checking
Global	Auto or SimulinkGlobal	Global variable	Label Mismatch Diagnostic (none / warning / error)
Global	Global	Global variable	Labels and storage classes must be identical (else error)

To summarize, the following signal resolution rules apply to code generation:

- If the storage class of a root input or output signal in a referenced model is Auto (or is SimulinkGlobal), the signal is passed as a function argument.
  - When such a signal is SimulinkGlobal or resolves to a Simulink.Signal object, the **Signal Mismatch** diagnostic is applied.
- If a root input or output signal in a referenced model is global, it is communicated by using direct memory access (global variable). In addition,
  - If the corresponding signal in the parent model is also global, the names and storage classes must match exactly.
  - If the corresponding signal in the parent model is not global, the **Signal Mismatch** diagnostic is applied.

You can set the **Signal Mismatch** diagnostic to error, warning, or none in the **Diagnostics > Connectivity** pane of the Configuration Parameters dialog box.

## Inherited Sample Time for Referenced Models

See “Inherit Sample Times” in the Simulink documentation for information about Model block sample time inheritance. In generated code, you can control inheriting sample time by using `ssSetModelReferenceSampleTimeInheritanceRule` in different ways:

- An S-function that precludes inheritance: If the sample time is used in the S-function’s run-time algorithm, then the S-function precludes a model from inheriting a sample time. For example, consider the following `mdlOutputs` code:

```
static void mdlOutputs(SimStruct *S, int_T tid)
{
    const real_T *u = (const real_T*)
        ssGetInputPortSignal(S,0);
    real_T      *y = ssGetOutputPortSignal(S,0);
    y[0] = ssGetSampleTime(S,tid) * u[0];
}
```

This `mdlOutputs` code uses the sample time in its algorithm, and the S-function therefore should specify

```
ssSetModelReferenceSampleTimeInheritanceRule
(S, DISALLOW_SAMPLE_TIME_INHERITANCE);
```

- An S-function that does not preclude Inheritance: If the sample time is only used for determining whether the S-function has a sample hit, then it does not preclude the model from inheriting a sample time. For example, consider the `mdlOutputs` code from the S-function example `sfun_multirate.c`:

```
static void mdlOutputs(SimStruct *S, int_T tid)
{
    InputRealPtrsType enablePtrs;
    int                *enabled = ssGetIWork(S);

    if (ssGetInputPortSampleTime
        (S,ENABLE_IPORT)==CONTINUOUS_SAMPLE_TIME &&
        ssGetInputPortOffsetTime(S,ENABLE_IPORT)==0.0) {
```

```
        if (ssIsMajorTimeStep(S) &&
            ssIsContinuousTask(S,tid) ) {
            enablePtrs =
                ssGetInputPortRealSignalPtrs(S,ENABLE_IPORT);
            *enabled = (*enablePtrs[0] > 0.0);
        }
    } else {
        int enableTid =
            ssGetInputPortSampleTimeIndex(S,ENABLE_IPORT);
        if (ssIsSampleHit(S, enableTid, tid) ) {
            enablePtrs =
                ssGetInputPortRealSignalPtrs(S,ENABLE_IPORT);
            *enabled = (*enablePtrs[0] > 0.0);
        }
    }

    if (*enabled) {
        InputRealPtrsType uPtrs =
            ssGetInputPortRealSignalPtrs(S,SIGNAL_IPORT);
        real_T            signal = *uPtrs[0];
        int                i;

        for (i = 0; i < NOUTPUTS; i++) {
            if (ssIsSampleHit(S,
                ssGetOutputPortSampleTimeIndex(S,i), tid) ) {
                real_T *y = ssGetOutputPortRealSignal(S,i);
                *y = signal;
            }
        }
    }
} /* end mdlOutputs */
```

The above code uses the sample times of the block, but only for determining whether there is a hit. Therefore, this S-function should set

```
ssSetModelReferenceSampleTimeInheritanceRule
(S, USE_DEFAULT_FOR_DISCRETE_INHERITANCE);
```

## Customize Library File Suffix and File Type

You can control the library file suffix and file type extension that the Simulink Coder code generator uses to name generated model reference libraries. Use the model configuration parameter `TargetLibSuffix` to specify the string for the suffix and extension. The string must include a period (.). If you do not set this parameter, the Simulink Coder software names the libraries as follows:

- On Windows systems, `model_rtwlib.lib`
- On UNIX or Linux<sup>®</sup> systems, `model_rtwlib.a`

## Reusable Code and Referenced Models

Models that employ model referencing might require special treatment when generating and using reusable code. The following sections identify general restrictions and discuss how reusable functions with inputs or outputs connected to a referenced model's root Inport or Outport blocks can affect code reuse.

### General Considerations

You can generate code for subsystems that contain referenced models using the same procedures and options described in “Code Generation of Subsystems” on page 2-2. However, the following restrictions apply to such builds:

- A top model that uses single-tasking mode and that has a submodel that uses multi-tasking mode executes for blocks with the different rates that are not connected. However, you get an error if the blocks with different rates are connected by Rate Transition block (inserted either manually or by Simulink).
- ERT S-functions do not support subsystems that contain a continuous sample time.
- The Simulink Coder S-function target is not supported.
- The Tunable parameters table (set by using the Model Parameter Configuration dialog box) is ignored; to make parameters tunable, you must define them as Simulink parameter objects in the base workspace.
- All other parameters are inlined into the generated code and S-function.

---

**Note** You can generate subsystem code using any target configuration available in the System Target File Browser. However, if the S-function target is selected, **Build This Subsystem** and **Build Selected Subsystem** behaves identically to **Generate S-Function**. (See “Automate S-Function Generation” on page 14-23.)

---



## Code Reuse and Model Blocks with Root Inport or Outport Blocks

Reusable functions with inputs or outputs connected to a referenced model's root Inport or Outport block can affect code reuse. This means that code for certain atomic subsystems cannot be reused in a model reference context the same way it is reused in a standalone model.

For example, suppose you create the following subsystem and make the following changes to the subsystem's block parameters:

- Select **Treat as an atomic unit**
- Go to the **Code Generation** tab and set **Function packaging** to Reusable function



Suppose you then create the following model, which includes three instances of the preceding subsystem.

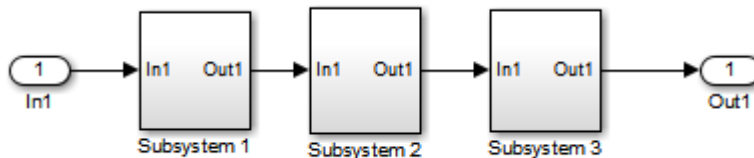

With the **Inline parameters** option enabled in this stand-alone model, the Simulink Coder code generator can optimize the code by generating a single copy of the function for the reused subsystem, as shown below.

```
void reuse_subsys1_Subsystem1(
    real_T rtu_0,
    rtB_reuse_subsys1_Subsystem1 *localB)
{
```

```
/* Gain: '<S1>/Gain' */
localB->Gain_k = rtu_0 * 3.0;
}
```

When generated as code for a Model block (into an `slprj` project folder), the subsystems have three different function signatures:

```
/* Output and update for atomic system: '<Root>/Subsystem1' */
void reuse_subsys1_Subsystem1(const real_T *rtu_0,
rtB_reuse_subsys1_Subsystem1
*localB)
{
/* Gain: '<S1>/Gain' */
localB->Gain_w = (*rtu_0) * 3.0;
}
```

```
/* Output and update for atomic system: '<Root>/Subsystem2' */
void reuse_subsys1_Subsystem2(real_T rtu_In1,
rtB_reuse_subsys1_Subsystem2
*localB)
{
/* Gain: '<S2>/Gain' */
localB->Gain_y = rtu_In1 * 3.0;
}
```

```
/* Output and update for atomic system: '<Root>/Subsystem3' */
void reuse_subsys1_Subsystem3(real_T rtu_In1, real_T *rty_0)
{
/* Gain: '<S3>/Gain' */
(*rty_0) = rtu_In1 * 3.0;
}
```

One way to make all the function signatures the same for code reuse, is to insert Signal Conversion blocks. Place one between the Inport and Subsystem1 and another between Subsystem3 and the Outport of the referenced model.

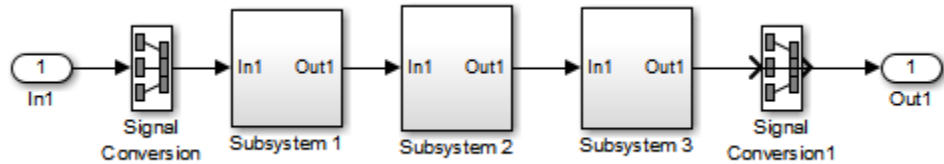

The result is a single reusable function:

```
void reuse_subsys2_Subsystem1(real_T rtu_In1,
                             rtB_reuse_subsys2_Subsystem1 *localB)
{
    /* Gain: '<S1>/Gain' */
    localB->Gain_g = rtu_In1 * 3.0;
}
```

You can achieve the same result (reusable code) with only one Signal Conversion block. You can omit the Signal Conversion block connected to the Inport block if you select the **Pass fixed-size scalar root inputs by value** check box at the bottom of the **Model Referencing** pane of the Configuration Parameters dialog box. When you do this, you still need to insert a Signal Conversion block before the Outport block.

## Simulink Coder Model Referencing Limitations

The following Simulink Coder limitations apply to model referencing. In addition to these limitations, a model reference hierarchy used for code generation must satisfy:

- The Simulink requirements listed in:
  - “Configuration Requirements for All Referenced Model Simulation”
  - “Model Structure Requirements”
- The Simulink limitations listed in “Model Referencing Limitations”.
- The Simulink Coder requirements applicable to the code generation target, as listed in “Configuration Parameter Requirements” on page 3-19.

### Customization Limitations

- The code generator ignores custom code settings in the **Configuration Parameter** dialog box and custom code blocks when generating code for a referenced model.
- Referenced models do not support custom storage classes if the parent model has inline parameters off.
- This release does not include Stateflow target custom code in simulation targets generated for referenced models.
- Data type replacement is not supported for simulation target code generation for referenced models.
- Simulation targets do not include Stateflow target custom code.
- If you have an Embedded Coder license, some restrictions exist on grouped custom storage classes in referenced models. For details, see “Custom Storage Class Limitations”.

### Data Logging Limitations

- To Workspace blocks, Scope blocks, and all types of runtime display, such as the display of port values and signal values, are ignored when the Simulink Coder software generates code for a referenced model. The resulting code is the same as if the constructs did not exist.

- Code generated for referenced models cannot log data to MAT-files. If data logging is enabled for a referenced model, the Simulink Coder software disables the option before code generation and re-enables it afterwards.
- If you log states for a model that contains referenced models, the ordering of the states in the output is determined by block sorted order, and might not match between simulation output and generated code MAT-file logging output.

### **State Initialization Limitation**

When a top model uses the **Load from workspace > Initial state option** to specify initial conditions, the Simulink Coder software does not initialize the states of any referenced models.

## Reusability Limitations

If a referenced model used for code generation has any of the following properties, the model must specify the configuration parameter **Model Referencing > Total number of instances allowed per top model** as **One**, and no other instances of the model can exist in the hierarchy. If you do not set the parameter to **One**, or more than one instance of the model exists in the hierarchy, an error occurs. The properties are:

- The model references another model which has been set to single instance
- The model contains a state or signal with non-auto storage class
- The model uses any of the following Stateflow constructs:
  - Machine-parented data
  - Machine-parented events
  - Stateflow graphical functions
- The model contains a subsystem that is marked as function
- The model contains an S-function that is:
  - Inlined but has not set the option `SS_OPTION_WORKS_WITH_CODE_REUSE`
  - Not inlined
- The model contains a function-call subsystem that:
  - Has been forced by the Simulink engine to be a function
  - Is called by a wide signal

## S-Function Limitations

- If a referenced model contains an S-function that should be inlined using a Target Language Compiler file, the S-function must use the `ssSetOptions` macro to set the `SS_OPTION_USE_TLC_WITH_ACCELERATOR` option in its `mdlInitializeSizes` method. The simulation target will not inline the S-function unless this flag is set.
- A referenced model cannot use noninlined S-functions generated by the Simulink Coder software.
- The Simulink Coder S-function target does not support model referencing.

For additional information, in the Simulink documentation, see “S-Functions with Model Referencing”.

## Simulink Tool Limitations

- Simulink tools that require access to a model’s internal data or configuration (including the Model Coverage tool, the Simulink Report Generator product, the Simulink debugger, and the Simulink profiler) have no effect on code generated by the Simulink Coder software for a referenced model, or on the execution of that code. Specifications made and actions taken by such tools are ignored and effectively do not exist.

## Subsystem Limitations

- If a subsystem contains Model blocks, you cannot build a subsystem module by right-clicking the subsystem (or by using **Code > C/C++ Code > Build Selected Subsystem**) unless the model is configured to use an ERT target.
- If you generate code for an atomic subsystem as a reusable function, inputs or outputs that connect the subsystem to a referenced model can affect code reuse, as described in “Reusable Code and Referenced Models” on page 3-32.

## Target Limitations

- Simulink Coder `grt_malloc` targets do not support model reference.
- The Simulink Coder S-function target does not support model referencing.

### Other Limitations

- Errors or unexpected behavior can occur if a Model block is part of a cycle, the Model block is a direct feedthrough block, and an algebraic loop results. For details, see “Model Blocks and Direct Feedthrough”.
- The **External mode** option is not supported. If it is enabled, it is ignored during code generation.



# Combined Models

---

## Combined Models

If you want to combine several models (or several instances of the same model) into a single executable, the Simulink Coder product offers several options.

The most powerful solution is to use Model blocks. Each instance of a Model block represents another model, called a *referenced model*. For code generation, the referenced model effectively replaces the Model block that references it. For details, see “Overview of Model Referencing” and “Generate Code for Referenced Models” on page 3-4.

When developing embedded systems using the Embedded Coder product, you can interface the code for several models to a common harness program by directly calling the entry points to each model. However, the Embedded Coder target has certain restrictions, relating to embedded processing, that might not be compatible with your application.

The GRT malloc target is another possible solution. Use it in situations where you want to:

- Selectively control calls to more than one model
- Use dynamic memory allocation
- Include models that employ continuous states
- Log data to multiple files
- Run one of the models in external mode

For more information, see “Use GRT Malloc to Combine Models” on page 4-4.

To summarize by target, your options are as follows:

Target	Support for Combining Multiple Models?
Generic Real-Time Target (grt.tlc)	Yes (using Model blocks)
Generic Real-Time Target with dynamic memory allocation (grt_malloc.tlc)	Yes

<b>Target</b>	<b>Support for Combining Multiple Models?</b>
Embedded Coder (ert.tlc)	Yes
S-function Target (rtwsfcn.tlc)	No

## Use GRT Malloc to Combine Models

This section discusses how to use the GRT malloc target to combine models into a single program.

Building a multiple-model executable is fairly straightforward:

- 1** Generate and compile code from each of the models that are to be combined.
- 2** Combine the makefiles for each of the models into one makefile for creating the final multimodel executable.
- 3** Create a combined simulation engine by modifying `grt_malloc_main.c` to initialize and call the models.
- 4** Run the combination makefile to link the object files from the models and the main program into an executable.

## Share Data Across Models

Use unidirectional signal connections between models. This affects the order in which models are called. For example, if an output signal from `modelA` is used as input to `modelB`, `modelA`'s output computation should be called first.

## Timing Issues

You must generate all the models you are combining with the same solver mode (either all single-tasking or all multitasking.) In addition, if the models employ continuous states, the same solver should be used for all models.

Because each model has its own model-specific definition of the `rtModel` data structure, you must use an alternative mechanism to control model execution, as follows:

- The file `rtw/c/src/rtmcmacros.h` provides an `rtModel` API clue that can be used to call the `rt_OneStep` procedure.
- The `rtmcmacros.h` header file defines the `rtModelCommon` data structure, which has the minimum common elements in the `rtModel` structure required to step a model forward one time step.

- The `rtmcsetCommon` macro populates an object of type `rtModelCommon` by copying the respective similar elements in the model's `rtModel` object. Your main routine must create one `rtModelCommon` structure for each model being called by the main routine.
- The main routine will subsequently invoke `rt_OneStep` with a pointer to the `rtModelCommon` structure instead of a pointer to the `rtModel` structure.

If the base rates for the models are not the same, the main program (such as `grt_malloc_main`) must set up the timer interrupt to occur at the greatest common divisor rate of the models. The main program calls each model at a time interval.

## **Data Logging and External Mode Support**

A multiple-model program can log data to separate MAT-files for each model.

Only one of the models in a multiple-model program can use external mode.



# Configure Model Parameters

---

- “Hardware Targets” on page 9-9
- “Describing the Emulation and Embedded Targets” on page 9-45
- “Describing Embedded Hardware Characteristics” on page 9-54
- “Describing Emulation Hardware Characteristics” on page 9-55
- “Control the Location for Generated Files” on page 5-18
- “Control Generated Files Location Used for Simulation” on page 5-20
- “Control the Location for Code Generation Files” on page 5-22
- “Override Build Folder Settings for Current Session” on page 5-24

## Platform Options for Development and Deployment

When you use Simulink software to create and execute a model, and Simulink Coder software to generate code, you may need to consider up to three platforms, often called *hardware targets*:

- MATLAB Host — The platform that runs MathWorks® software during application development
- Embedded Target — The platform on which an application will be deployed when it is put into production
- Emulation Target — The platform on which an application under development is tested before deployment

The same platform might serve in two or possibly all three capacities, but they remain conceptually distinct. Often the MATLAB host and the emulation target are the same. The embedded target is usually different from, and less powerful than, the MATLAB host or the emulation target; often it can do little more than run a downloaded executable file.

When you use Simulink software to execute a model for which you will later generate code, or use Simulink Coder software to generate code for deployment on an *embedded* target, you must provide information about the embedded target hardware and the compiler that you will use with it. The Simulink software uses this information to get bit-true agreement for the results of integer and fixed-point operations performed in simulation and in code generated for the embedded target. The Simulink Coder code generator uses the information to create code that executes with maximum efficiency.

When you generate code for testing on an *emulation* target, you must additionally provide information about the emulation target hardware and the compiler that you will use with it. The code generator uses this information to create code that provides bit-true agreement for the results of integer and fixed-point operations performed in simulation, in code generated for the embedded target, and in code generated for the emulation target. Agreement can result even though the embedded target and emulation target may use very different hardware, and the compilers for the two targets may use different defaults where the C standard does not completely define behavior.



## Configure Emulation and Embedded Target Hardware

The Configuration Parameters dialog **Hardware Implementation** pane provides options that you can use to describe hardware properties, such as data size and byte ordering, and compiler behavior details that may vary with the compiler, such as integer rounding. The **Hardware Implementation** pane contains two subpanes:

- **Embedded Hardware** — Describes the embedded target hardware and the compiler that you will use with it. This information affects both simulation and code generation.
- **Emulation Hardware** — Describes the emulation target hardware and the compiler that you will use with it. This information affects only code generation.

The two subpanes provide identical options and value choices. By default, the **Embedded Hardware** subpane initially looks like this:

Embedded hardware (simulation and code generation)

Device vendor:  Device type:

Number of bits

char:	<input type="text" value="8"/>	short:	<input type="text" value="16"/>	int:	<input type="text" value="32"/>
long:	<input type="text" value="32"/>	float:	<input type="text" value="32"/>	double:	<input type="text" value="64"/>
native:	<input type="text" value="32"/>	pointer:	<input type="text" value="32"/>		

Largest atomic size

integer:

floating-point:

Byte ordering:  Signed integer division rounds to:

Shift right on a signed integer as arithmetic shift

The default assumption is that the embedded target and emulation target are the same, so the **Emulation Hardware** subpane by default does not need to specify anything and contains only a checked option labeled **None**. Code generated under this configuration will be suitable for production use, or for testing in an environment identical to the production environment.

If you clear the check box, the **Emulation Hardware** subpane appears, initially showing the same values as the **Embedded Hardware** subpane. If you change any of these values, then generate code, the code will be able to execute in the environment specified by the **Emulation Hardware** subpane,

but will behave as if it were executing in the environment specified by the **Embedded Hardware** subpane. See “Describing Emulation Hardware Characteristics” on page 9-55 for details.

If you have used the **Code Generation** pane to specify a **System target file**, and the target file specifies a default microprocessor and its hardware properties, the default and properties appear as initial values in the **Hardware Implementation** pane.

Options with only one possible value cannot be changed. Any option that has more than one possible value provides a list of legal values. If you specify any hardware properties manually, check carefully that their values are consistent with the system target file. Otherwise, the generated code may fail to compile or execute, or may execute but give incorrect results.

---

**Note Hardware Implementation** pane options do not control hardware or compiler behavior. They describe hardware and compiler properties to MATLAB software, which uses the information to generate code for the platform that runs as efficiently as possible, and gives bit-true agreement for the results of integer and fixed-point operations in simulation, production code, and test code.

---

The rest of this section describes the options in the **Embedded Hardware** and **Emulation Hardware** subpanes. Subsequent sections describe considerations that apply only to one or the other subpane. For more about **Hardware Implementation** options, see “Hardware Implementation Pane”. To see an example of **Hardware Implementation** pane capabilities, run the `rtwdemo_targetsettings` example.

### Identify the Device Vendor

The **Device vendor** option gives the name of the device vendor. To set the option, select a vendor name from the **Device vendor** menu. Your selection of vendor will determine the available device values in the **Device type** list. If the desired vendor name does not appear in the menu, select **Generic** and then use the **Device type** option to further specify the device.

---

**Note**

- For complete lists of **Device vendor** and **Device type** values, see “Device vendor” and “Device type” in the Simulink reference documentation.
  - To add **Device vendor** and **Device type** values to the default set that is displayed on the **Hardware Implementation** pane, see “Registering Additional Device Vendor and Device Type Values” on page 9-47.
- 

## Identify the Device Type

The **Device type** option selects a hardware device among the supported devices listed for your **Device vendor** selection. To set the option, select a microprocessor name from the **Device type** menu. If the desired microprocessor does not appear in the menu, change the **Device vendor** to **Generic**.

If you specified the **Device vendor** as **Generic**, examine the listed device descriptions and select the device type that matches your hardware. If no available device type matches, select **Custom**.

If you select a device type for which the target file specifies default hardware properties, the properties appear as initial values in the subpane. Options with only one possible value cannot be changed. An option that has more than one possible value provides a list of legal values. Select values for your hardware. If the device type is **Custom**, more options can be set, and each option has a list of possible values.

## Register Additional Device Vendor and Device Type Values

To add **Device vendor** and **Device type** values to the default set that is displayed on the **Hardware Implementation** pane, you can use a hardware device registration API provided by the Simulink Coder software.

To use this API, you create an `sl_customization.m` file, located in your MATLAB path, that invokes the `registerTargetInfo` function and fills in a hardware device registry entry with device information. The device

information will be registered with Simulink software for each subsequent Simulink session. (To register your device information without restarting MATLAB, issue the MATLAB command `sl_refresh_customizations`.)

For example, the following `sl_customization.m` file adds device vendor `MyDevVendor` and device type `MyDevType` to the Simulink device lists.

```
function sl_customization(cm)
    cm.registerTargetInfo(@loc_register_device);
end
```

```
function thisDev = loc_register_device
    thisDev = RTW.HWDeviceRegistry;
    thisDev.Vendor = 'MyDevVendor';
    thisDev.Type = 'MyDevType';
    thisDev.Alias = {};
    thisDev.Platform = {'Prod', 'Target'};
    thisDev.setWordSizes([8 16 32 32 32]);
    thisDev.LargestAtomicInteger = 'Char';
    thisDev.LargestAtomicFloat = 'None';
    thisDev.Endianess = 'Unspecified';
    thisDev.IntDivRoundTo = 'Undefined';
    thisDev.ShiftRightIntArith = true;
    thisDev.setEnabled({'IntDivRoundTo'});
end
```

If you subsequently select the device in the **Hardware Implementation** pane, it is displayed as follows:

Embedded hardware (simulation and code generation)

Device vendor:  Device type:

Number of bits

char:	<input type="text" value="8"/>	short:	<input type="text" value="16"/>	int:	<input type="text" value="32"/>
long:	<input type="text" value="32"/>	float:	<input type="text" value="32"/>	double:	<input type="text" value="64"/>
native:	<input type="text" value="32"/>	pointer:	<input type="text" value="32"/>		

Largest atomic size

integer:

floating-point:

Byte ordering:  Signed integer division rounds to:

Shift right on a signed integer as arithmetic shift

To register multiple devices, you can specify an array of RTW.HWDeviceRegistry objects in your `sl_customization.m` file. For example,

```
function sl_customization(cm)
    cm.registerTargetInfo(@loc_register_device);
end

function thisDev = loc_register_device

    thisDev(1) = RTW.HWDeviceRegistry;
    thisDev(1).Vendor = 'MyDevVendor';
    thisDev(1).Type = 'MyDevType1';
    ...

    thisDev(4) = RTW.HWDeviceRegistry;
    thisDev(4).Vendor = 'MyDevVendor';
    thisDev(4).Type = 'MyDevType4';
    ...

end
```

The following table lists the RTW.HWDeviceRegistry properties that you can specify in the `registerTargetInfo` function call in your `sl_customization.m` file.

Property	Description
Vendor	String specifying the <b>Device vendor</b> value for your hardware device.
Type	String specifying the <b>Device type</b> value for your hardware device.

Property	Description
Alias	Cell array of strings specifying any aliases or legacy names that users might specify that should resolve to this device. Specify each alias or legacy name in the format 'Vendor->Type'. (Embedded Coder software provides the utility functions <code>RTW.isHWDeviceTypeEq</code> and <code>RTW.resolveHWDeviceType</code> for detecting and resolving alias values or legacy values when testing user-specified values for the target device type.)
Platform	Cell array of enumerated string values specifying whether this device should be listed in the <b>Embedded hardware</b> subpane ( <code>{'Prod'}</code> ), the <b>Emulation hardware</b> subpane ( <code>{'Target'}</code> ), or both ( <code>{'Prod', 'Target'}</code> ).
setWordSizes	Array of integer sizes to associate with the <b>Number of bits</b> parameters <b>char</b> , <b>short</b> , <b>int</b> , <b>long</b> , and <b>native word size</b> , respectively.
LargestAtomicInteger	String specifying an enumerated value for the <b>Largest atomic size: integer</b> parameter: 'Char', 'Short', 'Int', or 'Long'.
LargestAtomicFloat	String specifying an enumerated value for the <b>Largest atomic size: floating-point</b> parameter: 'Float', 'Double', or 'None'.
Endianess	String specifying an enumerated value for the <b>Byte ordering</b> parameter: 'Unspecified', 'Little' for little Endian, or 'Big' for big Endian.
IntDivRoundTo	String specifying an enumerated value for the <b>Signed integer division rounds to</b> parameter: 'Zero', 'Floor', or 'Undefined'.

Property	Description
ShiftRightIntArith	Boolean value specifying whether your compiler implements a signed integer right shift as an arithmetic right shift ( <code>true</code> ) or not ( <code>false</code> ).
setEnabled	Cell array of strings specifying which device properties should be enabled (modifiable) in the <b>Hardware Implementation</b> pane when this device type is selected. In addition to the 'Endianess', 'IntDivRoundTo', and 'ShiftRightIntArith' properties listed above, you can enable individual <b>Number of bits</b> parameters using the property names 'BitPerChar', 'BitPerShort', 'BitPerInt', 'BitPerLong', and 'NativeWordSize'.

## Set Native Word Size for the Device

The **Number of bits** options describe the **native word size** of the microprocessor, and the bit lengths of **char**, **short**, **int**, and **long** data. For code generation to succeed:

- The bit lengths must be such that **char** <= **short** <= **int** <= **long**.
- Bit lengths must be multiples of 8, with a maximum of 32.
- The bit length for **long** data must not be less than 32.

Simulink Coder integer type names are defined in the file `rtwtypes.h`. The values that you provide must be consistent with the word sizes as defined in the compiler's `limits.h` header file. The following table lists the standard Simulink Coder integer type names and maps them to the corresponding Simulink names.

Simulink Coder Integer Type	Simulink Integer Type
<code>boolean_T</code>	<code>boolean</code>
<code>int8_T</code>	<code>int8</code>
<code>uint8_T</code>	<code>uint8</code>

Simulink Coder Integer Type	Simulink Integer Type
int16_T	int16
uint16_T	uint16
int32_T	int32
uint32_T	uint32

If no ANSI<sup>®</sup> C type with a matching word size is available, but a larger ANSI C type is available, the Simulink Coder code generator uses the larger type for int8\_T, uint8\_T, int16\_T, uint16\_T, int32\_T, and uint32\_T.

An application can use integer data of any length from 1 (unsigned) or 2 (signed) bits up to 32 bits. If the integer length matches the length of an available type, the Simulink Coder code generator uses that type. If no matching type is available, the code generator uses the smallest available type that can hold the data, generating code that never uses unnecessary higher-order bits. For example, on a target that provided 8-bit, 16-bit, and 32-bit integers, a signal specified as 24 bits would be implemented as an int32\_T or uint32\_T.

Code that uses emulated integer data is not maximally efficient, but can be useful during application development for emulating integer lengths that are available only on production hardware. The use of emulation does not affect the results of execution.

### Set Byte Ordering Used By Device

The **Byte ordering** option specifies whether the target hardware uses **Big Endian** (most significant byte first) or **Little Endian** (least significant byte first) byte ordering. If left as **Unspecified**, the Simulink Coder software generates code that determines the endianness of the target; this is the least efficient option.



## Set Quotient Rounding Technique for Signed Integer Division

ANSI C does not completely define the quotient rounding technique to be used when dividing one signed integer by another, so the behavior is implementation-dependent. If both integers are positive, or both are negative, the quotient must round down. If either integer is positive and the other is negative, the quotient can round up or down.

The **Signed integer division rounds to** parameter tells the Simulink Coder code generator how the compiler rounds the result of signed integer division. Providing this information does not affect the operation of the compiler, it only describes that behavior to the code generator, which uses the information to optimize code generated for signed integer division. The parameter options are:

- **Zero** — If the quotient is between two integers, the compiler chooses the integer that is closer to zero as the result.
- **Floor** — If the quotient is between two integers, the compiler chooses the integer that is closer to negative infinity.
- **Undefined** — Choose this option if neither Zero nor Floor describes the compiler's behavior, or if that behavior is unknown.

The following table illustrates the compiler behavior that corresponds to each of these three options:

<b>N</b>	<b>D</b>	<b>Ideal N/D</b>	<b>Zero</b>	<b>Floor</b>	<b>Undefined</b>
33	4	8.25	8	8	8
-33	4	-8.25	-8	-9	-8 or -9
33	-4	-8.25	-8	-9	-8 or -9
-33	-4	8.25	8	8	8 or 9

---

**Note** Select `Undefined` only as a last resort. When the code generator does not know the signed integer division rounding behavior of the compiler, it generates extra code.

---

The compiler's implementation for signed integer division rounding can be obtained from the compiler documentation, or by experiment if no documentation is available.

### Set Arithmetic Right Shift Behavior for Signed Integers

ANSI C does not define the behavior of right shifts on negative integers, so the behavior is implementation-dependent. The **Shift right on a signed integer as arithmetic shift** parameter tells the code generator how the compiler implements right shifts on negative integers. Providing this information does not affect the operation of the compiler, it only describes that behavior to the code generator, which uses the information to optimize the code generated for arithmetic right shifts.

Select the option if the C compiler implements a signed integer right shift as an arithmetic right shift, and clear the option otherwise. An arithmetic right shift fills bits vacated by the right shift with the value of the most significant bit, which indicates the sign of the number in twos complement notation. The option is selected by default. If your compiler handles right shifts as arithmetic shifts, this is the preferred setting.

- When the option is selected, the Simulink Coder software generates simple efficient code whenever the Simulink model performs arithmetic shifts on signed integers.
- When the option is cleared, the Simulink Coder software generates fully portable but less efficient code to implement right arithmetic shifts.

The compiler's implementation for arithmetic right shifts can be obtained from the compiler documentation, or by experiment if no documentation is available.

## Configure Embedded Hardware Characteristics

“Describing the Emulation and Embedded Targets” on page 9-45 documents the options available on the **Hardware Implementation** subpanes. This section describes considerations that apply only to the **Embedded Hardware** subpane. When you use this subpane, keep the following in mind:

- Code generation targets can have word sizes and other hardware characteristics that differ from the MATLAB host. Furthermore, code can be prototyped on hardware that is different from either the deployment target or the MATLAB host. The Simulink Coder code generator takes these differences into account when generating code.
- The Simulink product uses some of the information in the **Embedded Hardware** subpane so that simulation without code generation gives the same results as executing generated code, including detecting error conditions that could arise on the target hardware, such as hardware overflow.
- The Simulink Coder software generates code that has bit-true agreement with Simulink results for integer and fixed-point operations. Generated code that emulates unavailable data lengths runs less efficiently than it would without emulation, but the emulation does not affect bit-true agreement with Simulink for integer and fixed-point results.
- If you change targets during application development, you must reconfigure the hardware implementation parameters for the new target before generating or regenerating code. Bit-true agreement might not be achieved for results of integer and fixed-point operations in simulation, production code, and test code when code executes on hardware for which it was not generated.
- Use the **Integer rounding mode** parameter on your model’s blocks to simulate the rounding behavior of the C compiler that you intend to use to compile code generated from the model. This setting appears on the **Signal Attributes** pane of the parameter dialog boxes of blocks that can perform signed integer arithmetic, such as the Product and n-D Lookup Table blocks.
- For most blocks, the value of **Integer rounding mode** completely defines rounding behavior. For blocks that support fixed-point data and the

Simplest rounding mode, the value of **Signed integer division rounds to** also affects rounding. For details, see “Rounding”.

- When models contain Model blocks, models that they reference must be configured to use identical hardware settings.

## Configure Emulation Hardware Characteristics

“Describing the Emulation and Embedded Targets” on page 9-45 documents the options available on the **Hardware Implementation** subpanes. This section describes considerations that apply only to the **Emulation Hardware** subpane.

---

**Note** (If the **Emulation Hardware** subpane contains a button labeled **Configure current execution hardware device**, see “Updating from Earlier Versions” on page 9-57, then continue from this point.)

---

The default assumption is that the embedded target and emulation target are the same, so the **Emulation Hardware** subpane by default does not need to specify anything and contains only a selected check box labeled **None**. Code generated under this configuration will be suitable for production use, or for testing in an environment identical to the production environment.

To generate code that runs on an emulation target for test purposes, but behaves as if it were running on an embedded target in a production application, you must specify the properties of both targets in the **Hardware Implementation** pane. The **Embedded Hardware** subpane specifies embedded target hardware properties, as described previously. To specify emulation target properties:

- 1 Clear the **None** option in the **Emulation Hardware** subpane.

By default, the **Hardware Implementation** pane now looks like this:

The image shows a configuration dialog box for embedded hardware, divided into two subpanes: "Embedded hardware (simulation and code generation)" and "Emulation hardware (code generation only)". Both subpanes have identical settings. In the "Embedded hardware" subpane, the "Device vendor" is set to "Generic", "Device type" is "Unspecified (assume 32-bit Gen)", and "Number of bits" for char, long, native, short, float, double, and pointer are all set to 32. The "Largest atomic size" is set to "Char", and "integer" is "Char", "floating-point" is "None", and "Signed integer division rounds to" is "Undefined". The "Byte ordering" is "Unspecified" and the checkbox "Shift right on a signed integer as arithmetic shift" is checked. The "Emulation hardware" subpane has the "None" checkbox selected, with all other settings identical to the "Embedded hardware" subpane.

- 2 In the **Emulation Hardware** subpane, specify the properties of the emulation target, using the instructions in “Describing the Emulation and Embedded Targets” on page 9-45

If you have used the **Code Generation** pane to specify a **System target file**, and the target file specifies a default microprocessor and its hardware properties, the default and properties appear as initial values in both subpanes of the **Hardware Implementation** pane.

Options with only one possible value cannot be changed. Any option that has more than one possible value provides a list of legal values. If you specify any hardware properties manually, check carefully that their values are consistent with the system target file. Otherwise, the generated code may fail to compile or execute, or may execute but give incorrect results.

If you do not display the **Emulation Hardware** subpane, the Simulink and Simulink Coder software defaults every **Emulation Hardware** option to

have the same value as the corresponding **Embedded Hardware** option. If you hide the **Emulation Hardware** subpane after setting its values, the values that you specified will be lost. The underlying configuration parameters immediately revert to the values that they had when you exposed the subpane, and these values, rather than the values that you specified, will appear if you re-expose the subpane.

## Update Release 14 Hardware Configuration

If your model was created before Release 14 and has not been updated, by default the **Hardware Implementation** pane initially looks like this:

The screenshot shows the **Hardware Implementation** pane. It is divided into two sections: **Embedded hardware (simulation and code generation)** and **Emulation hardware (code generation only)**.

**Embedded hardware (simulation and code generation)** section:

- Device vendor: Generic (dropdown)
- Device type: Unspecified (assume 32-bit Generic) (dropdown)
- Number of bits:
  - char: 8 (text input)
  - short: 16 (text input)
  - int: 32 (text input)
  - long: 32 (text input)
  - native word size: 32 (text input)
- Byte ordering: Unspecified (dropdown)
- Signed integer division rounds to: Undefined (dropdown)
- Shift right on a signed integer as arithmetic shift

**Emulation hardware (code generation only)** section:

- Configure current execution hardware device (button)

Click **Configure current execution hardware device**. The **Configure current execution hardware device** button disappears. The subpane then appears as shown in the first figure in this section. Save your model at this point to avoid redoing **Configure current execution hardware device** next time you access the **Hardware Implementation** pane.

## Control the Location for Generated Files

By default, the files generated by Simulink diagram updates and model builds are placed in a build folder, the root of which is the current working folder (pwd). If you are doing model builds, which potentially generate files for simulation targets as well as code generation targets, artifacts used for simulation and Simulink Coder code generation files coexist in subfolders within that build folder. However, in some situations, you might want the generated files to go to a root folder outside the current working folder. For example,

- You need to keep generated files separate from the models and other source materials used to generate them.
- You want to reuse or share previously-built simulation targets without having to set the current working folder back to a previous working folder.

You might also want to separate generated simulation artifacts from generated production code.

To allow you to control the output locations for the files generated by diagram updates and model builds, the software allows you to separately specify the following build folders:

- *Simulation cache folder* — root folder in which to place build artifacts used for simulation
- *Code generation folder* — root folder in which to place Simulink Coder code generation files

For specifying the folder locations, the software provides

- MATLAB session parameters `CacheFolder` and `CodeGenFolder`
- Simulink preferences **Simulation cache folder** and **Code generation folder**, which, if specified, provide the initial defaults for the MATLAB session parameters
- Function `Simulink.fileGenControl` for directly manipulating the MATLAB session parameters, for example, overriding or restoring the initial default values for the current session



For more information about setting up a simulation cache folder, see “Control Generated Files Location Used for Simulation” on page 5-20.

For more information about setting up a code generation folder, see “Control the Location for Code Generation Files” on page 5-22.

For more information about directly manipulating the MATLAB session parameters `CacheFolder` and `CodeGenFolder`, see “Override Build Folder Settings for Current Session” on page 5-24.

# Control Generated Files Location Used for Simulation

By default, the files generated by Simulink diagram updates are placed in a build folder, the root of which is the current working folder (pwd). However, in some situations, you might want the generated files to go to a root folder outside the current working folder. For example,

- You need to keep generated files separate from the models and other source materials used to generate them.
- You want to reuse or share previously-built simulation targets without having to set the current working folder back to a previous working folder.

The Simulink preference **Simulation cache folder** provides control over the output location for files generated by Simulink diagram updates. The preference appears in the Simulink Preferences Window, Main Pane, in the **File generation control** group. To specify the root folder location for files generated by Simulink diagram updates, set the preference value by entering or browsing to a folder path, for example:

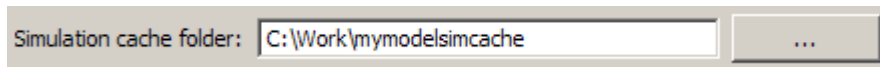

The folder path that you specify provides the initial default for the MATLAB session parameter `CacheFolder`. When you initiate a Simulink diagram update, any files generated are placed in a build folder at the root location specified by `CacheFolder` (if any), rather than in the current working folder (pwd).

For example, using a 32-bit Windows host platform, if you set the **Simulation cache folder** to 'C:\Work\mymodelsimcache' and then simulate the example model `rtwdemo_capi`, files are generated into the specified folder as follows:

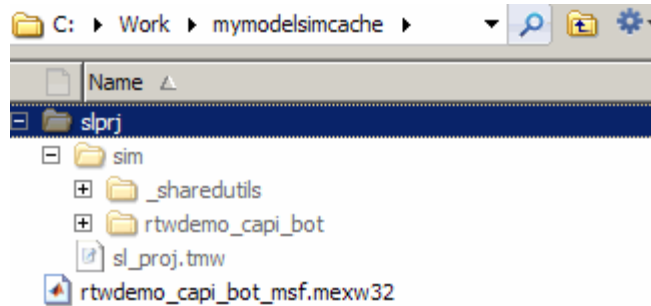

As an alternative to using the Simulink preferences GUI to set **Simulation cache folder**, you also can get and set the preference value from the command line using `get_param` and `set_param`. For example,

```
>> get_param(0, 'CacheFolder')
```

```
ans =
```

```
''
```

```
>> set_param(0, 'CacheFolder', fullfile('C:', 'Work', 'mymodelsimcache'))
```

```
>> get_param(0, 'CacheFolder')
```

```
ans =
```

```
C:\Work\mymodelsimcache
```

Also, you can choose to override the **Simulation cache folder** preference value for the current MATLAB session.

# Control the Location for Code Generation Files

By default, the files generated by Simulink model builds are placed in a build folder, the root of which is the current working folder (pwd). Model builds potentially generate files for simulation targets as well as code generation targets, and the resulting build folder contains both artifacts used for simulation and Simulink Coder code generation files. However, in some situations, you might want the generated files to go to one or more root folders outside the current working folder. For example,

- You need to keep generated files separate from the models and other source materials used to generate them.
- You want to separate generated production code from generated simulation artifacts.

The Simulink preference **Code generation folder** provides control over the output location for files generated by model builds for code generation targets. The preference appears in the Simulink Preferences Window, Main Pane, in the **File generation control** group. To specify the root folder location for code generation files generated by model builds, set the preference value by entering or browsing to a folder path, for example:

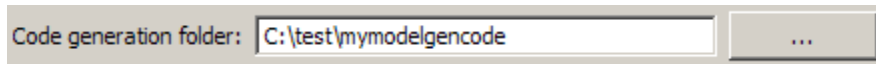

The folder path that you specify provides the initial default for the MATLAB session parameter `CodeGenFolder`. When you initiate a Simulink model build, any code generation files generated are placed in a build folder at the root location specified by `CodeGenFolder` (if any), rather than in the current working folder (pwd).

For example, using a 32-bit Windows host platform, if you set the **Code generation folder** to 'C:\test\mycodegenfolder' and then build the example model `rtwdemo_capi`, files are generated into the specified folder as follows:

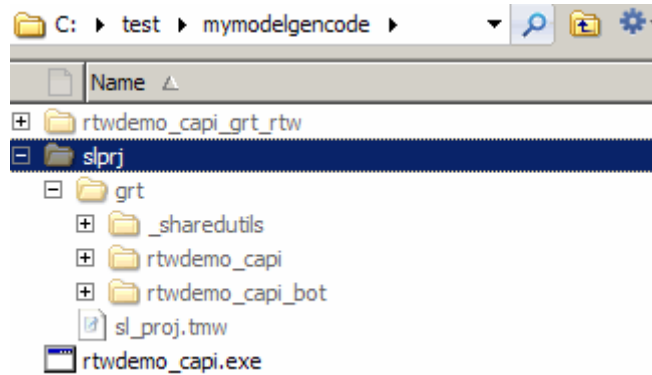

As an alternative to using the Simulink preferences GUI to set **Code generation folder**, you also can get and set the preference value from the command line using `get_param` and `set_param`. For example,

```
>> get_param(0, 'CodeGenFolder')

ans =

    ''

>> set_param(0, 'CodeGenFolder', fullfile('C:', 'test', 'mymodelgencode'))
>> get_param(0, 'CodeGenFolder')

ans =

C:\test\mymodelgencode
```

Also, you can choose to override the **Code generation folder** preference value for the current MATLAB session. For more information, see “Override Build Folder Settings for Current Session” on page 5-24.

# Override Build Folder Settings for Current Session

The Simulink preferences **Simulation cache folder** and **Code generation folder** provide the initial defaults for the MATLAB session parameters `CacheFolder` and `CodeGenFolder`, which determine where files generated by Simulink diagram updates and model builds are placed. However, you can override these build folder settings during the current MATLAB session, using the `Simulink.fileGenControl` function. This function allows you to directly manipulate the MATLAB session parameters, for example, overriding or restoring the initial default values. The values you set using `Simulink.fileGenControl` expire at the end of the current MATLAB session. For more information and detailed examples, see the `Simulink.fileGenControl` function reference page.

# Model Protection

---

- “Protect a Referenced Model” on page 6-2
- “Harness Model” on page 6-4
- “Protected Model Report” on page 6-5
- “Code Generation Support in a Protected Model” on page 6-6
- “Protected Model File” on page 6-8
- “Create a Protected Model” on page 6-9
- “Test the Protected Model” on page 6-13
- “Save Base Workspace Definitions” on page 6-15
- “Package a Protected Model” on page 6-16

## Protect a Referenced Model

Protect a model when you want to share a model with a third party without revealing the intellectual property. Protecting a model does not use encryption technology.

When you create a protected model:

- By default, Simulink creates and stores a protected version of the referenced model in the current working folder. The protected model has the same name as the source model, with a `.slxp` extension.
- The original Model block does not change. However, if the Model block parameter **Model name** does not specify an extension, a protected model, `.slxp`, takes precedence over a model file, `.slx`.
- The **Simulation mode** parameter of the protected model is automatically set to `Accelerator`. You cannot change this value.
- You can optionally create a harness model which includes the protected model. A shield icon appears in the lower-left corner of the protected model block in the harness model. For more information, see “Harness Model” on page 6-4.
- You can optionally include generated code with the protected model so that a third party can generate code for a model that contains the protected model. Including code generation support with a protected model also allows the third party to simulate a model that references the protected model in Accelerator mode. For more information, see “Code Generation Support in a Protected Model” on page 6-6.
- If the Model block uses variants, only the active variant is protected. For more information, see “Set Up Model Variants”.
- If you rename a protected model, or change its suffix, the model is unusable until you restore its original name and suffix. You cannot change a protected model internally because any internal change destroys the usability of the file.

You can create a protected model using either:

- A Model block context menu. For more information, see “Create a Protected Model” on page 6-9 and



- A `Simulink.ModelReference.protect` function.

## **Requirements for Protecting a Model**

When you create a protected model from a referenced model, the referenced model must meet all requirements listed in “Model Referencing Limitations”, as well as these requirements:

- You must have a Simulink Coder license to create a protected model.
- A model that you protect must be available on the MATLAB path and not have any unsaved changes.
- A model that you protect cannot reference a protected model directly or indirectly.
- A model that you protect cannot use a non-inlined S-function directly or indirectly.

Model protection has certain limitations, as listed in “Limitations on All Model Referencing” and “Limitations on Accelerator Mode Referenced Models”.

## Harness Model

You can create a harness model for the generated protected model. The harness model opens as a new, untitled model that contains only a Model block which references the protected model. This Model block:

- Specifies the Model block parameter, **Model name**, as the name of the protected model.
- Has a shield icon in the lower-left corner.
- Has the same number of input and output ports as the protected model.
- Defines any model reference arguments that the protected model uses, but does not provide any values.

To create a harness model, see “Create a Protected Model” on page 6-9. You can use a harness model to test your protected model. For more information, see “Test the Protected Model” on page 6-13. You can also copy the Model block in your harness model to another model, where it is an interface to the protected model.

## Protected Model Report

You can generate a report for a protected model to include with the protected model. The report provides information to the receiver to determine if the protected model can be used. The report has:

- A **Summary**, including the Simulink version and platform used to create the protected model.
- An **Interface Report**, including model interface information, such as, input and output specifications, exported function information, and whether code generation support is included.

A protected model report is generated while the protected model is created. In the Create Protected Model dialog box, select the **Create protected model report** parameter. For an example, see “Create a Protected Model” on page 6-9.

After you create the protected model, to view the protected model report, double-click the protected model block.

## Code Generation Support in a Protected Model

You can create a protected model that supports code generation. When a protected model includes generated code, a third party can generate code for a model that includes the protected model. If you choose to obfuscate the code, all code is obfuscated before compilation. The protected model file contains only obfuscated headers and binaries. No source, such as, .c and .cpp, is present in the protected model file, although the headers are documented in the protected model report. For more information, see “Protected Model File” on page 6-8 and “Protected Model Report” on page 6-5.

In the Create Protected Model dialog box, select the **Include generated code** parameter, which enables the **Obfuscate code** parameter. For an example on including code generation support, see “Create a Protected Model” on page 6-9.

### Protected Model Requirements to Support Code Generation

Contents and configuration of a model might prevent code generation support of the protected model. Interaction between the parent model and the protected model might also prevent code generation.

- Code generation for the protected model is only supported for Accelerator mode and a single target. Both GRT and ERT targets cannot be supported by the same protected model.
- A protected model cannot include a model reference hierarchy.
- Source code comments in the **Code Generation > Comments** pane are ignored. Obfuscation of the generated code removes comments because comments might reveal intellectual property.
- Custom code in the **Code Generation > Custom Code** pane should not be included. Custom code is obfuscated, but identifiers are not.
- Code generation of a model that includes a protected model produces an error, if:
  - Their interfaces do not match.
  - There are incompatible parameters.

- A protected model and another model share the same name in the same model reference hierarchy.

## Protected Model File

A protected model file (.slxp) consists of the model itself and supporting files, depending on the options that you selected when you created the protected model.

If you created a protected model for simulation only, after simulation, the *model.mexext* file is placed in the build folder.

For simulation with a report, these additional files are unpacked:

- `slprj/sim/model/html/*`
- `slprj/sim/model/buildinfo.mat`

If you opted to include code generation support when you created the protected model, after building your model the following files are unpacked (in addition to the preceding files):

- `slprj/sim/model/*.h`
- `slprj/sim/model/modellib.a` (or `modellib.lib`)
- `slprj/sim/model/tmwinternal/*`
- `slprj/sim/_sharedutils/*`
- `slprj/target/model/*.h`
- `slprj/target/model/model_rtwlib.a` (or `model_rtwlib.lib`)
- `slprj/target/model/buildinfo.mat`
- `slprj/target/_sharedutils/*`
- `slprj/target/model/tmwinternal/*`

For code generation with a report, after building your model these files are unpacked (in addition to the preceding files):

- `slprj/target/model/html/*`
- `slprj/target/model/buildinfo.mat`
- `slprj/target/_sharedutils/html/*`

## Create a Protected Model

This example shows how to create a protected model to be used for simulation and code generation.

- 1 Open the model `rtwdemo_roll`.
- 2 In the Simulink Editor, right-click the Model block that references the model for which you want to generate protected model code. In this example, right-click `HeadingMode`.
- 3 From the context menu, select **Block Parameters (ModelReference)**.
- 4 In the Block Parameters dialog box, in the **Model name** field, specify the extension for the model, `.slx`. When both the model and the protected model exist in the same folder, `.slxp` takes precedence over `.slx`. In the **Model name** field, if you do not specify an extension, when you create the protected model, the original Model block in the model becomes protected.
- 5 Click **Apply** and **OK**.
- 6 Right-click the Model block. From the context menu, select **Subsystem & Model Reference > Create Protected Model for Selected Model Block**.
- 7 In the Create Protected Model dialog box, select **Include generated code** to include generated code with the protected model. This parameter enables and selects the **Obfuscate code** parameter. For more information about the generated code, see “Code Generation Support in a Protected Model” on page 6-6.
- 8 In the **Package path** field, specify the folder path for the protected model. The default value is the current working folder.
- 9 To create a harness model for the protected model, select **Create harness model for protected model**.

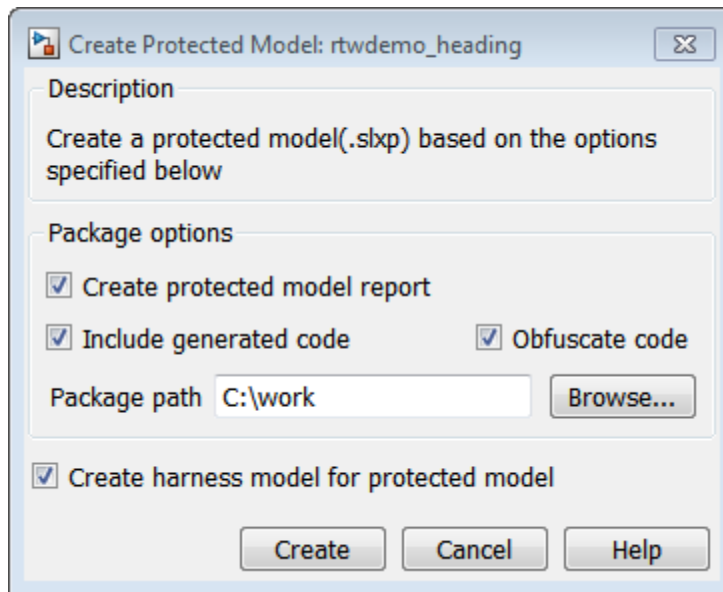

- 10 Click **Create**. An untitled harness model opens and contains a Model block, which refers to the protected model `rtwdemo_heading.slxp`. The **Simulation mode** for the Model block is set to `Accelerator`. You cannot change the mode.



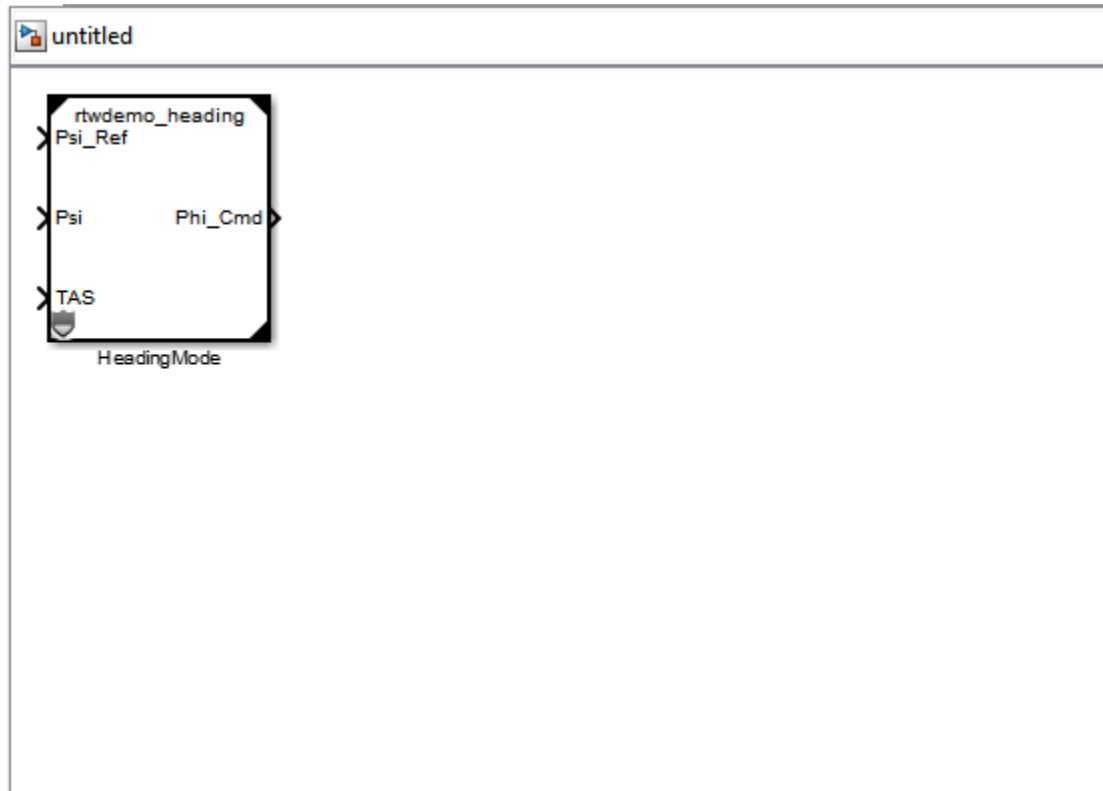

- 11 To view the protected model report, double-click the `HeadingMode` block.

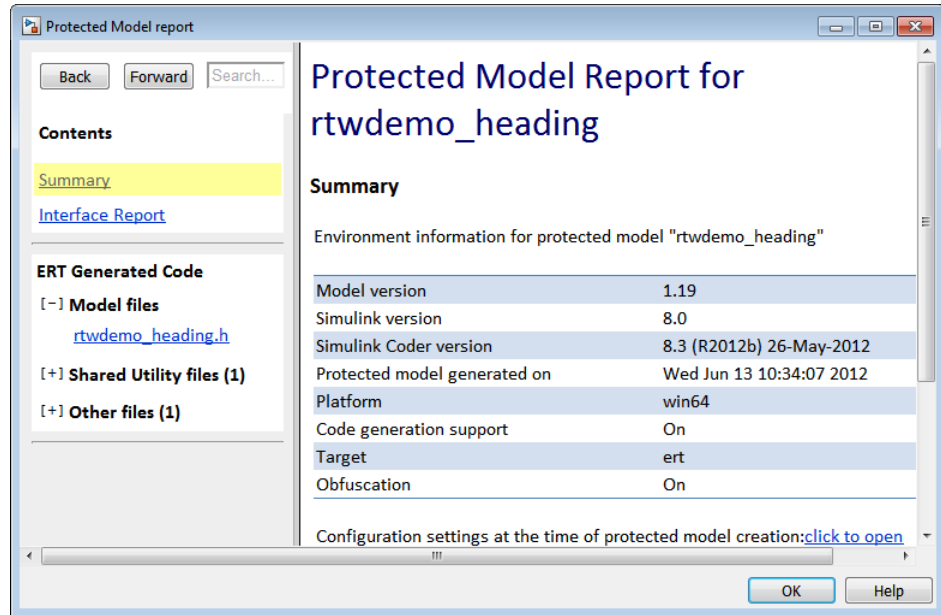

To test the protected model before packaging, see “Test the Protected Model” on page 6-13. To package the protected model for a third party, see “Package a Protected Model” on page 6-16.

## Test the Protected Model

To test a protected model that you created, you use the generated harness model and the procedure described in “Use Protected Model in Simulation”.

You can also compare the output of the protected model to the output of the original model. Because you are the supplier, both the original and the protected model might exist on the MATLAB path. In the original model, if the Model block **Model name** parameter names the model without providing a suffix, the protected model takes precedence over the unprotected model. If you need to override this default when testing the output, in the Model block **Model name** parameter, specify the file name with the extension of the unprotected model, `.slx`.

To compare the unprotected and protected versions of a Model block, use the Simulation Data Inspector. This example uses `rtwdemo_roll` and the protected model, `rtwdemo_heading.slxp`, which is created in “Create a Protected Model” on page 6-9.

- 1** If it is not already open, open `rtwdemo_roll`.
- 2** Enable logging for the output signal of the Model block, `HeadingMode`. In the Configuration Parameters dialog box, on the **Data Import/Export** pane, select the **Signal logging** parameter and set **Signal logging format** to `Dataset`. Click **Apply** and **OK**.
- 3** Right-click the output signal. From the context menu, select **Properties**. In the Signal Properties dialog box, select **Log signal data**. Click **Apply** and **OK**. For more information, see “Export Signal Data Using Signal Logging”.
- 4** Right-click the `HeadingMode` block. From the context menu, select **Block Parameters (ModelReference)**. In the Block Parameters dialog box, specify the **Model name** parameter with the name of the unprotected model and the extension, `rtwdemo_heading.slx`. Click **Apply** and **OK**.
- 5** In the Simulink Editor, click the **Record** button on. Simulate the model. When the simulation is complete, the Simulation Data Inspector opens.

- 6 In the Simulation Data Inspector, rename the run to indicate that it is for the unprotected model.
- 7 In the Simulink Editor, right-click the HeadingMode block. From the context menu, select **Block Parameters (ModelReference)**. In the Block Parameters dialog box, specify the **Model name** parameter with the name of the protected model, `rtwdemo_heading.slxp`. A shield icon appears on the Model block.
- 8 In the Simulink Editor, the **Record** button is still on. Simulate the model, which now refers to the protected model. When the simulation is complete, the Simulation Data Inspector opens.
- 9 In the Simulation Data Inspector, rename the new run to indicate that it is for the protected model.
- 10 In the Simulation Data Inspector, select the **Compare Runs** tab to compare the runs for the unprotected and the protected model. For more information about comparing runs, see “Compare All Logged Signal Data From Multiple Simulations”.

## Save Base Workspace Definitions

Referenced models might use object definitions or tunable parameters that are defined in the MATLAB base workspace. These variables are not saved with the model. When you protect a model, you must obtain the definitions of required base workspace entities and ship them with the model.

The following base workspace variables must be saved to a MAT-file:

- Global tunable parameter
- Global data store
- Any of the following objects used by a signal that connects to a root-level model Inport or Outport:
  - `Simulink.Signal`
  - `Simulink.Bus`
  - `Simulink.Alias`
  - `Simulink.NumericType` that is an alias

For more information, see “Workspace Variables in Model Explorer”.

Before executing the protected model as a part of a third-party model, the receiver of the protected model must load the MAT-file.

## Package a Protected Model

In addition to the protected model file (.slxp), you might need to include additional files in the protected model package:

- Harness model file.
- Any required definitions saved in a MAT-file. For more information, see “Save Base Workspace Definitions” on page 6-15.
- Instructions on how to retrieve the files.

Some ways to deliver the protected model package are:

- Provide the .slxp file and other supporting files as separate files.
- Combine the files into a ZIP or other container file.
- Combine the files using a manifest. For more information, see “Export Files in a Manifest”.
- Provide the files in some other standard or proprietary format specified by the receiver.

Whichever approach you use to deliver a protected model, include information on how to retrieve the original files. One approach to consider is to use the Simulink Manifest Tools, as described in “Analyze Model Dependencies”.

# Data, Function, and File Definition

---

- Chapter 7, “Data Representation”
- Chapter 8, “Entry Point Functions and Scheduling”





# Data Representation

---

- “Enumerations” on page 7-2
- “Structure Parameters and Generated Code” on page 7-49
- “Parameters” on page 7-10
- “Signals” on page 7-52
- “States” on page 7-83
- “Data Stores” on page 7-93

## Enumerations

### In this section...

“About Enumerated Data Types” on page 7-2

“Default Code for an Enumerated Data Type” on page 7-2

“Type Casting for Enumerations” on page 7-3

“Override Default Methods (Optional)” on page 7-4

“Enumerated Type Limitations” on page 7-7

### About Enumerated Data Types

*Enumerated data* is data that is restricted to a finite set of values. An *enumerated data type* is a MATLAB class that defines a set of *enumerated values*. Each enumerated value consists of an *enumerated name* and an *underlying integer* which the software uses internally and in generated code. The following is a MATLAB class definition for an enumerated data type named `BasicColors`, which is used in the examples in this section.

```
classdef(Enumeration) BasicColors < Simulink.IntEnumType
    enumeration
        Red(0)
        Yellow(1)
        Blue(2)
    end
end
```

For information about enumerated data types and their use in Simulink models, see “Use Enumerated Data in Simulink Models”. For information about enumerated data types in Stateflow charts, see “How to Define Enumerated Data in a Chart”.

### Default Code for an Enumerated Data Type

By default, enumerated data types in generated code are defined in the generated header file `model_types.h` for the model. For example, the default code for `BasicColors`, which is defined in the previous section, appears as follows:

```
#ifndef _DEFINED_TYPEDEF_FOR_BasicColors_  
#define _DEFINED_TYPEDEF_FOR_BasicColors_  
  
typedef enum {  
    Red = 0,          /* Default value */  
    Yellow = 1,  
    Blue = 2,  
} BasicColors;  
  
#endif
```

## Type Casting for Enumerations

### How Safe Casting Works

A Simulink Data Type Conversion block can accept a signal of integer type and convert the input to one of the underlying values of an enumerated type.

If the input value does not match any of the underlying values of the enumerated type's values, Simulink can insert a safe cast to replace the input value with the enumerated type's default value.

### Enable and Disable Safe Casting

You can enable or disable safe casting for enumerations during code generation for a Simulink Data Type Conversion block or a Stateflow block.

To control safe casting, enable or disable the block's **Saturate on integer overflow** parameter. The parameter works as follows:

- **Enabled:** Simulink replaces a non-matching input value with the default value of the enumerated values during simulation and generates a safe cast function during code generation.
- **Disabled:** For a non-matching input value, Simulink generates an error during simulation and omits the safe cast function during code generation. While the code is more efficient in this case, it may be more vulnerable to runtime errors.

## Safe Cast Function in Generated Code

This example shows how the safe cast function `int32_T ET08_safe_cast_to_BasicColors` for the enumeration `BasicColors` appears in generated code.

```
static int32_T ET08_safe_cast_to_BasicColors(int32_T input)
{
    int32_T output;
    /* Initialize output value to default value for BasicColors (Red) */
    output = 0;
    if ((input >= 0) && (input <= 2)) {
        /* Set output value to input value if it is a member of BasicColors */
        output = input;
    }
    return output;
}
```

Through this function, the enumerated type's default value is used if the input value does not match one of underlying values of the enumerated type's values.

If the block's **Saturate on integer overflow** parameter is disabled, this function does not appear in generated code.

## Override Default Methods (Optional)

Every enumerated class has four associated static methods, which it inherits from *Simulink.IntEnumType*. You can optionally override any or all of these static methods to customize the behavior of an enumerated type. The methods are:

- `getDefaultValue` — Returns the default value of the enumerated data type.
- `getDescription` — Returns a description of the enumerated data type.
- `getHeaderFile` — Specifies a file where the type is defined for generated code.
- `addClassNameToEnumNames` — Specifies whether the class name becomes a prefix in code.

The first of these methods, `getDefaultValue`, is relevant to both simulation and code generation, and is described in “Specifying a Default Enumerated Value” in the Simulink documentation. The other three methods are relevant only to code generation, and are described in this section. To override any of the methods, include a customized version of the method in the enumerated class definition’s `methods` section. If you do not want to override any default methods, omit the `methods` section entirely. The following table summarizes the four methods and the data to supply for each one:

Method	Purpose	Default Return	Custom Return
<code>getDefaultValue</code>	Returns the default value for the class, which must be an instance of the class.	The lexically first value in the enumeration.	Any enumerated value in the class. See “Instantiate Enumerations”.
<code>getDescription</code>	Returns a string containing a description of the enumerated class.	''	Any string that MATLAB accepts.
<code>getHeaderFile</code>	Returns a string containing the name of the header file	''	The name of the file that contains the enumerated type definition.
<code>addClassNameToEnumNames</code>	Returns a boolean value indicating whether to prefix the class name in generated code	false	true or false

### Specifying a Description

To specify a description for an enumerated data type, include the following method in the enumerated class’s `methods` section:

```
function retVal = getDescription()
% GETDESCRIPTION Optional string to describe the data type.
    retVal = 'description';
end
```

Substitute any legal MATLAB string for *description*. The generated code that defines the enumerated type will include the specified description.

### **Specify a Header File**

To prevent the declaration of an enumerated type from being embedded in the generated code, allowing you to provide the declaration in an external file, include the following method in the enumerated class's `methods` section:

```
function retVal = getHeaderFile()
% GETHEADERFILE File where type is defined for generated code.
% If specified, this file is #included in the code.
% Otherwise, the type is written out in the generated code.
retVal = 'filename';
end
```

Substitute any legal filename for *filename*. Be sure to provide a filename suffix, typically `.h`. Providing the method replaces the declaration that would otherwise have appeared in `model_types.h` with a `#include` statement like:

```
#include "imported_enum_type.h"
```

The `getHeaderFile` method does not create the declaration file itself. You must provide a file of the specified name that declares the enumerated data type.

### **Add Prefixes To Class Names**

By default, enumerated values in generated code have the same names that they have in the enumerated class definition. Alternatively, the code can prefix every enumerated value in an enumerated class with the name of the class. This technique can be useful for preventing identifier conflicts or improving the clarity of the code. To specify class name prefixing, include the following method in an enumerated class's `methods` section:

```
function retVal = addClassNameToEnumNames()
% ADDCLASSNAMETOENUMNAMES Control whether class name is added as
% a prefix to enumerated names in the generated code.
% By default the code does not use the class name as a prefix.
retVal = boolean;
end
```

Replace *boolean* with `true` to enable class name prefixing, or `false` to suppress prefixing without having to delete the method itself. If *boolean* is `true`, each enumerated value in the class appears in generated code as *EnumTypeName\_EnumName*. For `BasicColors`, which was defined in “About Enumerated Data Types” on page 7-2, the data type definition with class name prefixing looks like this:

```
#ifndef _DEFINED_TYPEDEF_FOR_BasicColors_
#define _DEFINED_TYPEDEF_FOR_BasicColors_

typedef enum {
    BasicColors_Red = 0,           /* Default value */
    BasicColors_Yellow = 1,
    BasicColors_Blue = 2,
} BasicColors;

#endif
```

In this example, the enumerated class name `BasicColors` appears as a prefix for each of the enumerated names. The definition is otherwise the same as it would be without name prefixing.

## Enumerated Type Limitations

- Generated code does not support logging enumerated data.

## Structure Parameters and Generated Code

### In this section...

“About Structure Parameters and Generated Code” on page 7-49

“Include Structure Parameters in Generated Code” on page 7-50

“Control Naming of Structure Parameter Types” on page 7-50

### About Structure Parameters and Generated Code

Structure parameters provide a way to improve generated code to use structures rather than multiple separate variables. You also have the option of configuring the appearance of a structure parameter in generated code.

For more information about structure parameters, see “Structure Parameters” in the Simulink documentation. For an example of how to convert a model that uses unstructured workspace variables to a model that uses structure parameters, see `sldemo_applyVarStruct`.

### Configure Structure Parameters for Generated Code

By default, structure parameters do not appear in generated code. Structure parameters include numeric variables and the code generator inlines numeric values.

To make structure type definition appear in generated code for a structure parameter,

- 1 Create a `Simulink.Parameter` object.
- 2 Define the object value to be the parameter structure.
- 3 Define the object storage class to be a value other than `Auto`.

The code generator places a structure type definition or the tunable parameter structure in `model_types.h`. By default, the code generator identifies the type with a nondescriptive, automatically generated name, such as `struct_z98c0D2qc4btL`.



For information on how to control the naming of the type, see “Control Naming of Structure Parameter Types” on page 7-50. For an example, see `sldemo_applyVarStruct`

## Control Name of Structure Parameter Type

To control the naming of a structure parameter type, use a `Simulink.Bus` object to specify the data type of the `Simulink.Parameter` object.

- 1 Use `Simulink.Bus.createObject` to create a bus object with the same shape as the parameter structure. For example:

```
busInfo=Simulink.Bus.createObject(ControlParam.Value);
```

- 2 Assign the bus object name to the data type property of the parameter object.

```
ParamType=eval(busInfo.busName);  
ControlParam.DataType='Bus: ParamType';
```

Only `Simulink.Parameter` can accept the bus object name as a data type.

For an example, see `sldemo_applyVarStruct`

## Parameters

### In this section...

- “About Parameters” on page 7-10
- “Nontunable Parameter Storage” on page 7-11
- “Tunable Parameter Storage” on page 15-119
- “Tunable Parameter Storage Classes” on page 15-121
- “Declare Tunable Parameters” on page 15-124
- “Tunable Expressions” on page 15-128
- “Linear Block Parameter Tunability” on page 15-132
- “Configuration Parameter Quick Reference Diagram” on page 7-27
- “Generated Code for Parameter Data Types” on page 7-28
- “Tunable Workspace Parameter Data Type Considerations” on page 15-133
- “Tune Parameters” on page 7-36
- “Parameter Objects” on page 7-38
- “Structure Parameters and Generated Code” on page 7-49

### About Parameters

This section discusses how the Simulink Coder product generates parameter storage declarations, and how you can generate the storage declarations you need to interface block parameters to your code. For information about defining block parameters in Simulink models, see “Set Block Parameters”.

If you are using S-functions in your model and intend to tune their run-time parameters in the generated code, see “Tuning Run-Time Parameters” in the Simulink documentation. Note that

- Parameters must be numeric, logical, or character arrays.
- Parameters may not be sparse.
- Parameter arrays must not be greater than 2 dimensions.

For guidance on implementing a parameter tuning interface using a C API, see “Data Interchange Using the C API” on page 15-137.

Simulink external mode offers a way to monitor signals and modify parameter values while generated model code executes. However, external mode might not be the optimal solution for your application. For example, the S-function target does not support external mode. For other targets, you might want your existing code to access parameters and signals of a model directly, rather than using the external mode communications mechanism. For information on external mode, see “Host/Target Communication” on page 15-50.

## Nontunable Parameter Storage

By default, block parameters are not tunable in the generated code. When **Inline Parameters** is off (the default), the Simulink Coder product has control of parameter storage declarations and the symbolic naming of parameters in the generated code.

Nontunable parameters are stored as fields within *model\_P* (formerly *rtP*), a model-specific global parameter data structure. The Simulink Coder product initializes each field of *model\_P* to the value of the corresponding block parameter at code generation time.

When the **Inline parameters** option is on, block parameters are evaluated at code generation time, and their values appear as constants in the generated code, if possible (in certain circumstances, parameters cannot be inlined, and are then included in a constant parameter or model parameter structure.)

As an example of nontunable parameter storage, consider the following model.

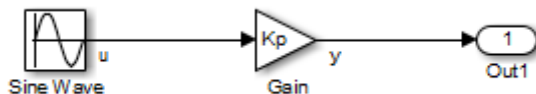

The workspace variable *Kp* sets the gain of the Gain block.

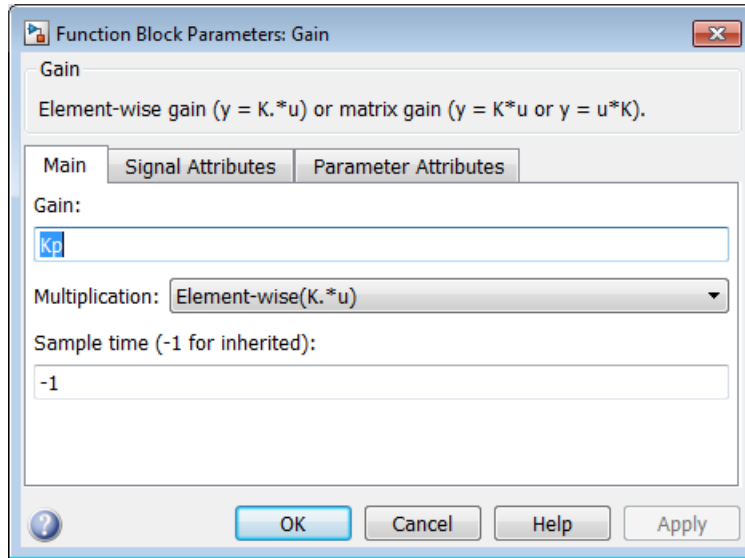

Assume that  $K_p$  is nontunable and has a value of 5.0. The next table shows the variable declarations and the code generated for  $K_p$  in the noninlined and inlined cases.

The generated code does not preserve the symbolic name  $K_p$ . The noninlined code represents the gain of the Gain block as `model_P.Gain_Gain`. When  $K_p$  is noninlined, the parameter is tunable.

Inline Parameters	Generated Variable Declaration and Code
Off	<pre> struct Parameters_non_tunable_sin { real_T SineWave_Amp;     real_T SineWave_Bias;     real_T SineWave_Freq;     real_T SineWave_Phase;     real_T Gain_Gain; }; . . . Parameters_non_tunable_sin non_tunable_sin_P = { </pre>

Inline Parameters	Generated Variable Declaration and Code
	<pre> 1.0 , /* SineWave_Amp : '&lt;Root&gt;/Sine Wave' */ 0.0 , /* SineWave_Bias : '&lt;Root&gt;/Sine Wave' */ 1.0 , /* SineWave_Freq : '&lt;Root&gt;/Sine Wave' */ 0.0 , /* SineWave_Phase : '&lt;Root&gt;/Sine Wave' */ 5.0  /* Gain_Gain : '&lt;Root&gt;/Gain' */ }; . . . non_tunable_sin_Y.Out1 = rtb_u * non_tunable_sin_P.Gain_Gain; </pre>
On	<pre> non_tunable_sin_Y.Out1 = rtb_u * 5.0; </pre>

## Tunable Parameter Storage

A *tunable* parameter is a block parameter whose value can be changed at run-time. A tunable parameter is inherently noninlined. Consequently, when **Inlined parameters** is off, all parameters are members of *model\_P*, and thus are tunable. A *tunable expression* is an expression that contains one or more tunable parameters.

When you declare a parameter tunable, you control whether or not the parameter is stored within *model\_P*. You also control the symbolic name of the parameter in the generated code.

When you declare a parameter tunable, you specify

- The *storage class* of the parameter.

The storage class property of a parameter specifies how the Simulink Coder product declares the parameter in generated code.

The term “storage class,” as used in the Simulink Coder product, is not synonymous with the term *storage class specifier*, as used in the C language.

- A *storage type qualifier*, such as `const` or `volatile`. This is simply a string that is included in the variable declaration.
- (Implicitly) the symbolic name of the variable or field in which the parameter is stored. The Simulink Coder product derives variable and field names from the names of tunable parameters.

The Simulink Coder product generates a variable or `struct` storage declaration for each tunable parameter. Your choice of storage class controls whether the parameter is declared as a member of `model_P` or as a separate global variable.

You can use the generated storage declaration to make the variable visible to external legacy code. You can also make variables declared in your code visible to the generated code. You are responsible for linking your code to generated code modules.

You can use tunable parameters or expressions in your root model and in masked or unmasked subsystems, subject to certain restrictions. (See “Tunable Expressions” on page 15-128.)

### **Override Inlined Parameters for Tuning**

When the **Inline parameters** option is selected, you can use the Model Parameter Configuration dialog box to remove individual parameters from inlining and declare them to be tunable. This allows you to improve overall efficiency by inlining most parameters, while at the same time retaining the flexibility of run-time tuning for selected parameters. Another way you can achieve the same result is by using Simulink data objects; see “Parameters” on page 7-10 for specific details.

The mechanics of declaring tunable parameters are discussed in “Declare Tunable Parameters” on page 15-124.

### **Tunable Parameter Storage Classes**

The Simulink Coder product defines four storage classes for tunable parameters. You must declare a tunable parameter to have one of the following storage classes:

- **SimulinkGlobal (Auto)**: This is the default storage class. The Simulink Coder product stores the parameter as a member of *model\_P*. Each member of *model\_P* is initialized to the value of the corresponding workspace variable at code generation time.
- **ExportedGlobal**: The generated code instantiates and initializes the parameter and *model.h* exports it as a global variable. An exported global variable is independent of the *model\_P* data structure. Each exported global variable is initialized to the value of the corresponding workspace variable at code generation time.
- **ImportedExtern**: *model\_private.h* declares the parameter as an extern variable. Your code must supply the variable definition and initializer.
- **ImportedExternPointer**: *model\_private.h* declares the variable as an extern pointer. Your code must supply the pointer variable definition and initializer, if any.

The generated code for *model.h* includes *model\_private.h* to make the extern declarations available to subsystem files.

As an example of how the storage class declaration affects the code generated for a parameter, consider the next figure.

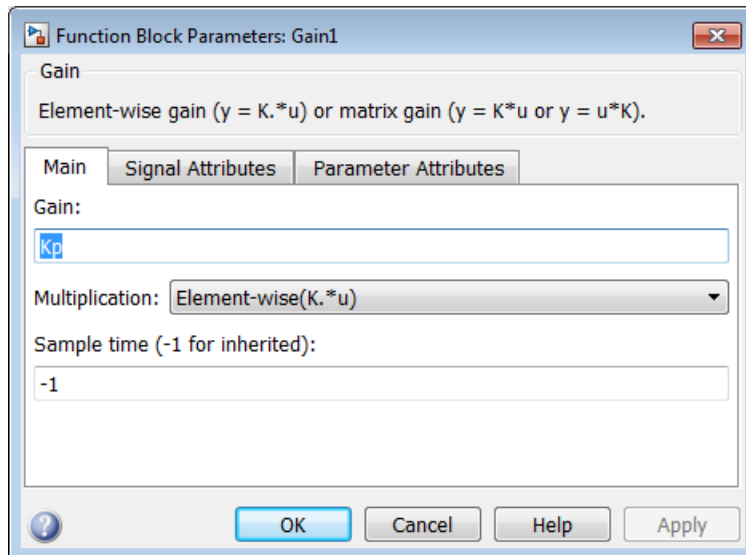

The workspace variable `Kp` sets the gain of the `Gain` block. Assume that the value of `Kp` is 3.14. The following table shows the variable declarations and the code generated for the gain block when `Kp` is declared as a tunable parameter. An example is shown for each storage class.

**Note** The Simulink Coder product uses column-major ordering for two-dimensional signal and parameter data. When interfacing your hand-written code to such signals or parameters by using `ExportedGlobal`, `ImportedExtern`, or `ImportedExternPointer` declarations, make sure that your code observes this ordering convention.

The symbolic name `Kp` is preserved in the variable and field names in the generated code.

Storage Class	Generated Variable Declaration and Code
<p>SimulinkGlobal (Auto)</p>	<pre>typedef struct _Parameters_tunable_sin Parameters_tunable_sin;  struct _Parameters_tunable_sin {     real_T Kp; };  Parameters_tunable_sin tunable_sin_P = {     3.14 }; . . tunable_sin_Y.Out1 = rtb_u * tunable_sin_P.Kp;</pre>
<p>ExportedGlobal</p>	<pre>real_T Kp = 3.14; . . tunable_sin_Y.Out1 = rtb_u * Kp;</pre>



Storage Class	Generated Variable Declaration and Code
ImportedExtern	<pre>extern real_T Kp; . . tunable_sin_Y.Out1 = rtb_u * Kp;</pre>
ImportedExtern Pointer	<pre>extern real_T *Kp; . . tunable_sin_Y.Out1 = rtb_u * (*Kp);</pre>

## Declare Tunable Parameters

- “Declare Workspace Variables as Tunable Parameters” on page 15-124
- “Declare New Tunable Parameters” on page 15-124
- “Declare Tunable Parameters Using Configuration Parameter Dialog” on page 15-125
- “Select Workspace Variables” on page 15-126
- “Create New Tunable Parameters” on page 15-127
- “Set Tunable Parameter Properties” on page 15-128
- “Remove Unused Tunable Parameters” on page 15-128

## Declare Workspace Variables as Tunable Parameters

To declare tunable parameters,

- 1 Open the Model Parameter Configuration dialog box.
- 2 In the **Source list** pane, select one or more variables.
- 3 Click **Add to table** . The variables then appear as tunable parameters in the **Global (tunable) parameters** pane.

- 4 Select a parameter in the **Global (tunable) parameters** pane.
- 5 Select a storage class from the **Storage class** menu.
- 6 Optionally, select (or enter) a storage type qualifier, such as `const` or `volatile` for the parameter.
- 7 Click **Apply**, or click **OK** to apply changes and close the dialog box.

### Declare New Tunable Parameters

To declare tunable parameters,

- 1 Open the Model Parameter Configuration dialog box.
- 2 In the **Global (tunable) parameters** pane, click **New**.
- 3 Specify a name for the parameter.
- 4 Select a storage class from the **Storage class** menu.
- 5 Optionally, select (or enter) a storage type qualifier, such as `const` or `volatile` for the parameter.
- 6 Click **Apply**, or click **OK** to apply changes and close the dialog box.

### Declare Tunable Parameters Using Configuration Parameters

The Model Configuration Parameters dialog box lets you select base workspace variables and declare them to be tunable parameters in the current model. Using controls in the dialog box, you move variables from a source list to a global (tunable) parameter list for a model.

To open the dialog box,

- 1 Select the **Inline parameters** check box on the **Optimization > Signals and Parameters** pane of the Configuration Parameters dialog box. This activates a **Configure** button, as shown below.

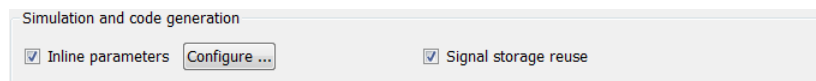

**2** Click **Configure** to open the Model Configuration Parameters dialog box.

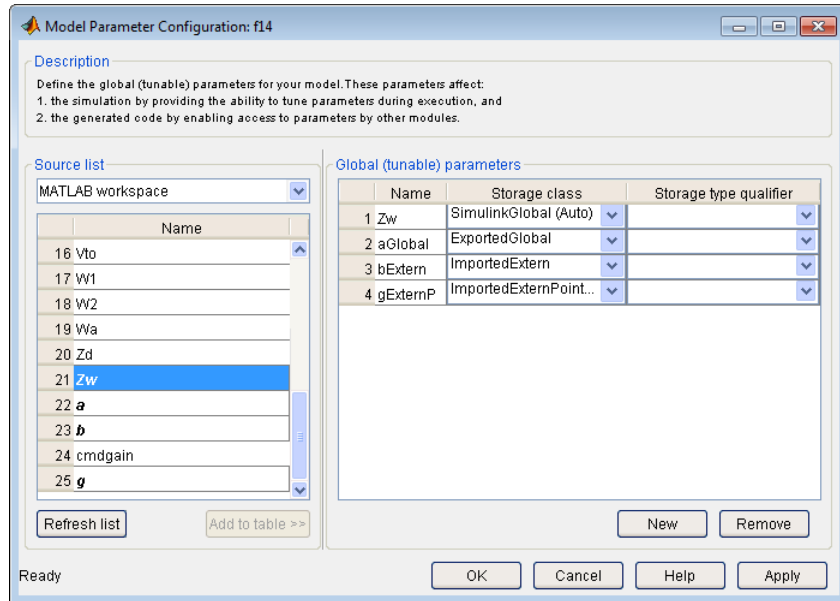

**Note** The Model Configuration Parameters dialog box cannot tune parameters within referenced models. See “Parameterize Model References” for tuning techniques that work with referenced models.

## Select Workspace Variables

The **Source list** pane displays a menu and a scrolling table of numerical workspace variables. To select workspace variables,

**1** From the menu, select the source of variables you want listed.

To List...	Choose...
All variables in the MATLAB workspace that have numeric values	MATLAB workspace
Only variables in the MATLAB workspace that have numeric values and are referenced by the model	Referenced workspace variables

A list of workspace variables appear in the **Source List** pane.

- 2** Select one or more variables from the source list. This enables the **Add to table** button.
- 3** Click **Add to table** to add the selected variables to the tunable parameters list in the **Global (tunable) parameters** pane. In the **Source list**, the names of variables added to the tunable parameters list are displayed in bold type (see the preceding figure).

---

**Note** If you selected a variable with a name that matches a block parameter that is not tunable and you click **Add to table** , a warning appears during simulation and code generation.

---

To update the list of variables to reflect the current state of the workspace, at any time, click **Refresh list** . For example, you might use **Refresh list** if you define or remove variables in the workspace while the Model Parameter Configuration dialog box is open.

### Create New Tunable Parameters

To create a new tunable parameter,

- 1** In the **Global (tunable) parameters** pane, click **New**.
- 2** In the **Name** field, enter a name for the parameter.

If you enter a name that matches the name of a workspace variable in the **Source list** pane, that variable is declared tunable and appears in italics in the **Source list**.

### 3 Click **Apply**.

The model does not need to be using a parameter before you create it. You can add references to the parameter later.

---

**Note** If you edit the name of an existing variable in the list, you actually create a new tunable variable with the new name. The previous variable is removed from the list and loses its tunability (that is, it is inlined).

---

## Set Tunable Parameter Properties

To set the properties of tunable parameters listed in the **Global (tunable) parameters** pane, select a parameter and then specify a storage class and, optionally, a storage type qualifier.

Property	Description
Storage class	<p>Select one of the following to be used for code generation:</p> <ul style="list-style-type: none"> <li>• SimulinkGlobal (Auto)</li> <li>• ExportedGlobal</li> <li>• ImportedExtern</li> <li>• ImportedExternPointer</li> </ul> <p>See “Tunable Parameter Storage Classes” on page 15-121 for definitions.</p>
Storage type qualifier	<p>For variables with any storage class <i>except</i> SimulinkGlobal (Auto), you can add a qualifier (such as <code>const</code> or <code>volatile</code>) to the generated storage declaration. To do so, you can select a predefined qualifier from the list or add qualifiers not in the list. The code</p>

Property	Description
	generator does not check the storage type qualifier for validity, and includes the qualifier string in the generated code without checking syntax .

### Remove Unused Tunable Parameters

To remove unused tunable parameters from the table in the **Global (tunable) parameters** pane, click **Remove**. Removed variables are inlined if the **Inlined parameters** option is enabled.

## Tunable Expressions

- “Tunable Expressions in Masked Subsystems” on page 15-129
- “Tunable Expression Limitations” on page 15-131

The Simulink Coder product supports the use of tunable variables in expressions. An expression that contains one or more tunable parameters is called a *tunable expression*.

### Tunable Expressions in Masked Subsystems

Tunable expressions are allowed in masked subsystems. You can use tunable parameter names or tunable expressions in a masked subsystem dialog box. When referenced in lower-level subsystems, such parameters remain tunable.

As an example, consider the masked subsystem in the next figure. The masked variable `k` sets the gain parameter of `theGain`.



Suppose that the base workspace variable `b` is declared tunable with `SimulinkGlobal (Auto)` storage class. The next figure shows the tunable expression `b*3` in the subsystem's mask dialog box.

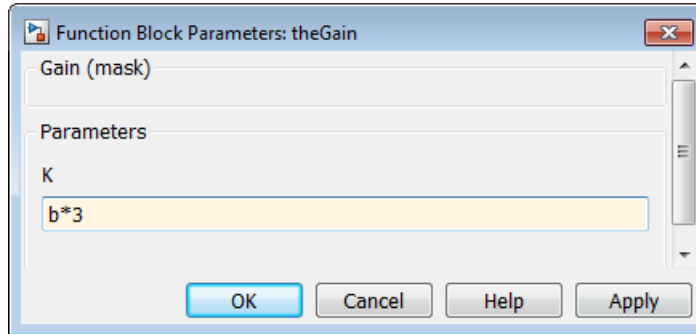

### Tunable Expression in Subsystem Mask Dialog Box

The Simulink Coder product produces the following output computation for `theGain`. The variable `b` is represented as a member of the global parameters structure, `model_P`. (For clarity in showing the individual Gain block computation, expression folding is off in this example.)

```
/* Gain: '<S1>/theGain' */
   rtb_theGain_C = rtb_SineWave_n * ((subsys_mask_P.b * 3.0));

/* Output: '<Root>/Out1' */
   subsys_mask_Y.Out1 = rtb_theGain_C;
```

As this example shows, for GRT targets, the parameter structure is mangled to create the structure identifier `model_P` (subject to the identifier length constraint). This is done to avoid namespace clashes in combining code from multiple models using model reference. ERT-based targets provide ways to customize identifier names.

When expression folding is on, the above code condenses to

```
/* Output: '<Root>/Out1' incorporates:
 * Gain: '<S1>/theGain'
 */
subsys_mask_Y.Out1 = rtb_SineWave_n * ((subsys_mask_P.b * 3.0));
```

Expressions that include variables that were declared or modified in mask initialization code are *not* tunable.

As an example, consider the subsystem above, modified as follows:

- The mask initialization code is

```
t = 3 * k;
```

- The parameter `k` of the `myGain` block is  $4 + t$ .
- Workspace variable `b = 2`. The expression  $b * 3$  is plugged into the mask dialog box as in the preceding figure.

Since the mask initialization code can run only once, `k` is evaluated at code generation time as

```
4 + (3 * (2 * 3) )
```

The Simulink Coder product inlines the result. Therefore, despite the fact that `b` was declared tunable, the code generator produces the following output computation for `theGain`. (For clarity in showing the individual Gain block computation, expression folding is off in this example.)

```
/* Gain Block: <S1>/theGain */  
rtb_temp0 *= (22.0);
```

### **Tunable Expression Limitations**

Currently, there are certain limitations on the use of tunable variables in expressions. When an unsupported expression is encountered during code generation a warning is issued and the equivalent numeric value is generated in the code. The limitations on tunable expressions are

- Complex expressions are not supported, except where the expression is simply the name of a complex variable.
- The use of certain operators or functions in expressions containing tunable operands is restricted. Restrictions are applied to four categories of operators or functions, classified in the following table:



Category	Operators or Functions
1	+ - .* ./ < > <= >= == ~= &
2	* /
3	abs, acos, asin, atan, atan2, boolean, ceil, cos, cosh, exp, floor, log, log10, sign, sin, sinh, sqrt, tan, tanh,
4	single, int8, int16, int32, uint8, uint16, uint32
5	: .^ ^ [] {} . \ .\ ' .' ; ,

The rules applying to each category are as follows:

- Category 1 is unrestricted. These operators can be used in tunable expressions with any combination of scalar or vector operands.
- Category 2 operators can be used in tunable expressions where at least one operand is a scalar. That is, scalar/scalar and scalar/matrix operand combinations are supported, but not matrix/matrix.
- Category 3 lists functions that support tunable arguments. Tunable arguments passed to these functions retain their tunability. Tunable arguments passed to any other functions lose their tunability.
- Category 4 lists the casting functions that do not support tunable arguments. Tunable arguments passed to these functions lose their tunability.

---

**Note** The Simulink Coder product casts values using MATLAB typecasting rules. The MATLAB typecasting rules are different from C code typecasting rules. For example, using the MATLAB typecasting rules, `int8(3.7)` returns the result 4, while in C code `int8(3.7)` returns the result 3.

---

- Category 5 operators are not supported.
- Expressions that include variables that were declared or modified in mask initialization code are *not* tunable.
- The Fcn block does not support tunable expressions in code generation.

- Model workspace parameters can take on only the `Auto` storage class, and thus are not tunable. See “Parameterize Model References” for tuning techniques that work with referenced models.
- Non-double expressions are not supported.
- Blocks that access parameters only by address support the use of tunable parameters, if the parameter expression is a simple variable reference. When an operation such as a data type conversion or a math operation is applied, the Simulink Coder product creates a nontrivial expression that cannot be accessed by address, resulting in an error during the build process.

## Linear Block Parameter Tunability

The following blocks have a `Realization` parameter that affects the tunability of their parameters:

- Transfer Fcn
- State-Space
- Discrete State-Space

The `Realization` parameter must be set by using the MATLAB `set_param` function, as in the following example.

```
set_param(gcf, 'Realization', 'auto')
```

The following values are defined for the `Realization` parameter:

- `general`: The block’s parameters are preserved in the generated code, permitting parameters to be tuned.
- `sparse`: The block’s parameters are represented in the code by transformed values that increase the computational efficiency. Because of the transformation, the block’s parameters are no longer tunable.
- `auto`: This setting is the default. A `general` realization is used if one or more of the block’s parameters are tunable. Otherwise `sparse` is used.

---

**Note** To tune the parameter values of a block of one of the above types without restriction during an external mode simulation, you must set Realization to general.

---

### **Code Reuse for Subsystems with Mask Parameters**

The Simulink Coder product can generate reusable (reentrant) code for a model containing identical atomic subsystems. Selecting the **Reusable function** option for **Function packaging** enables such code reuse, and causes a single function with arguments to be generated that is called when any of the identical atomic subsystem executes. See “Subsystems” for details and restrictions on the use of this option.

Mask parameters become arguments to reusable functions. However, for reuse to occur, each instance of a reusable subsystem must declare the same set of mask parameters. If, for example subsystem A has mask parameters **b** and **K**, and subsystem B has mask parameters **c** and **K**, then code reuse is not possible, and the Simulink Coder product will generate separate functions for A and B.

### **Configuration Parameter Quick Reference Diagram**

The next figure shows the code generation and storage class options that control the representation of parameters in generated code.

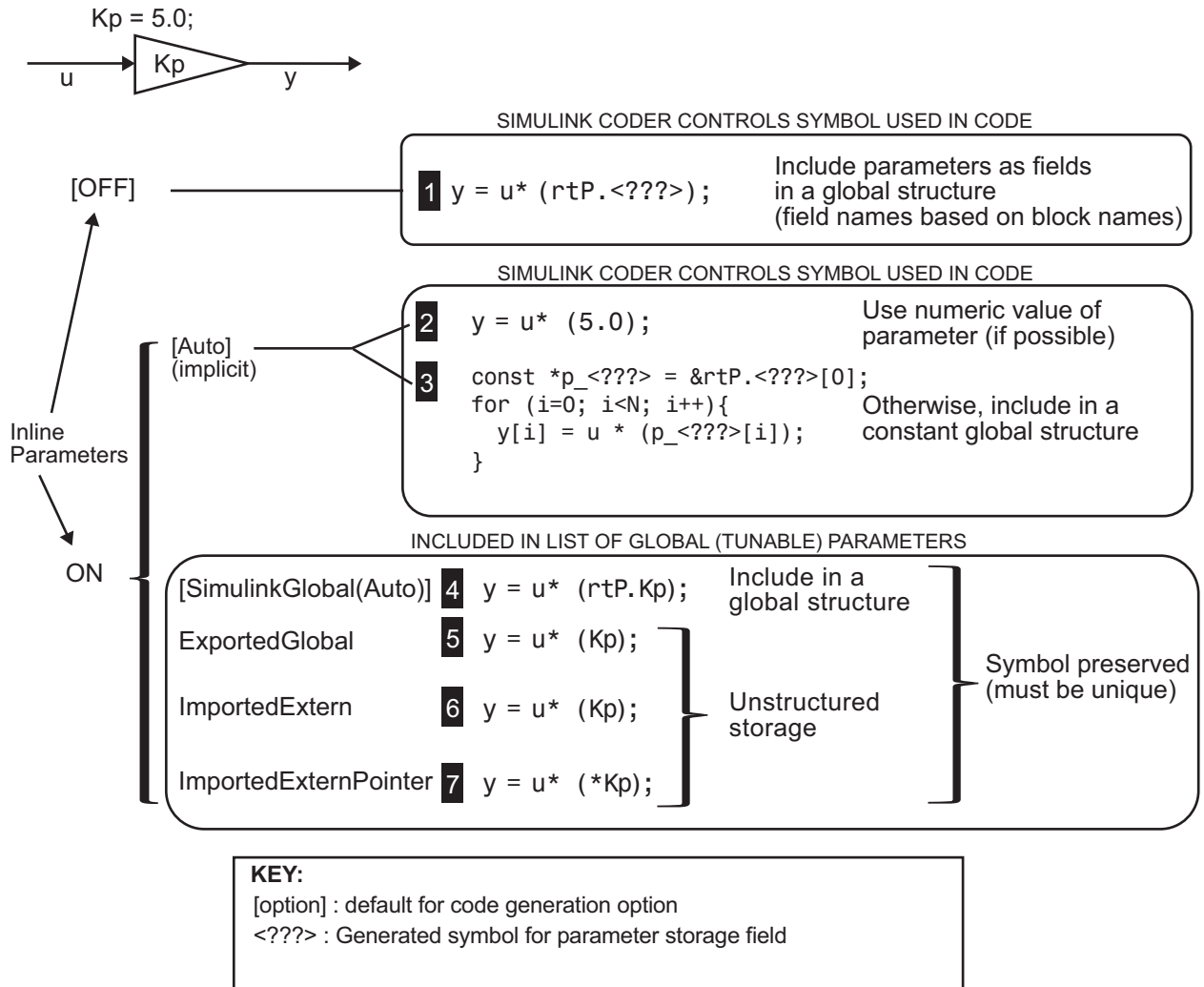

## Generated Code for Parameter Data Types

For an example of the code generated from Simulink parameters with different data types, run the model `rtwdemo_paramdt`. This model shows options that are available for controlling the data type of tunable parameters in the generated code. The model's subsystem includes several instances of

Gain blocks feeding Saturation blocks. Each pair of blocks uses a workspace variable of a particular data type, as shown in the next figure.

Inlined parameters (InLineParameters ON + Auto storage class)  
 ==> numeric value inlined

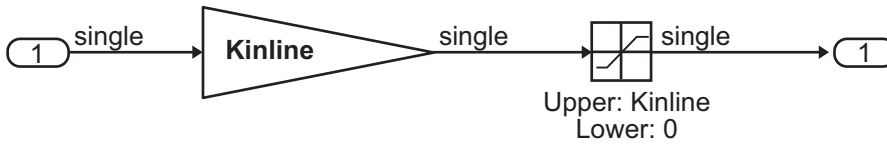

Double-precision (context-sensitive) parameters  
 ==> tunable parameter inherits data type from run-time parameter

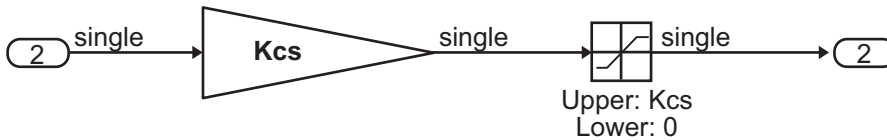

Tunable parameters with explicit data type specification  
 ==> parameter is cast to run-time parameter data type in generated code

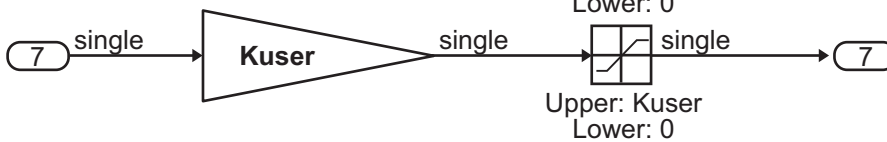
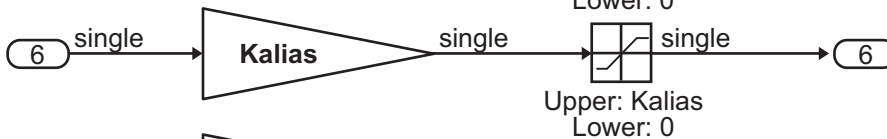
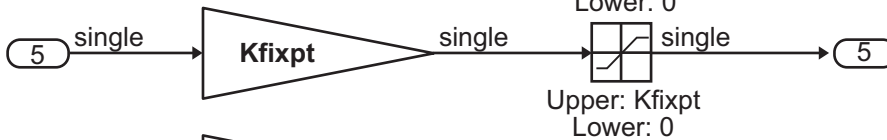
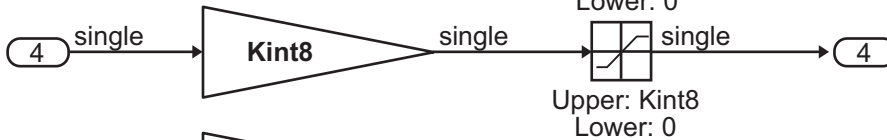
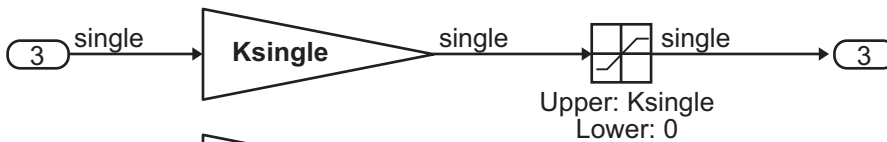

The Simulink engine initializes the parameters in the model by executing the script `rtwdemo_paramdt_data.m`. You can view the initialization script and inspect the workspace variables in Model Explorer by double-clicking the yellow boxes in the model.

In the model, note that the **Inline parameters** option on the **Optimization > Signals and Parameters** pane of the **Configuration Parameters** dialog box is selected. The **Model Parameter Configuration** dialog box reveals that all base workspace variables (with the exception of `Kinline`) have their **Storage class** property set to `ExportedGlobal`. Consequently, `Kinline` is a nontunable parameter while the remaining variables are tunable parameters.

To generate code for the model, double-click the blue boxes. The following table shows both the MATLAB code used to initialize parameters and the code generated for each parameter in the `rtwdemo_paramdt` model.

Parameter & MATLAB Code	Generated Variable Declaration and Code
<p><b>Kinline</b></p> <p><code>Kinline = 2;</code></p>	<pre>rtb_Gain1 = rtwdemo_paramdt_U.In1 * 2.0F; . . rtwdemo_paramdt_Y.Out1 = rt_SATURATE(rtb_Gain1, 0.0F, 2.0F);</pre>
<p><b>Kcs</b></p> <p><code>Kcs = 3;</code></p>	<pre>real32_T Kcs = 3.0F; . . rtb_Gain1 = rtwdemo_paramdt_U.In2 * Kcs; . . rtwdemo_paramdt_Y.Out2 = rt_SATURATE(rtb_Gain1, 0.0F, Kcs);</pre>

Parameter & MATLAB Code	Generated Variable Declaration and Code
<p><b>Ksingle</b></p> <pre>Ksingle = single(4);</pre>	<pre>real32_T Ksingle = 4.0F; . . rtb_Gain1 = rtwdemo_paramdt_U.In3 * Ksingle; . . rtwdemo_paramdt_Y.Out3 = rt_SATURATE(rtb_Gain1, 0.0F, Ksingle);</pre>
<p><b>Kint8</b></p> <pre>Kint8 = int8(5);</pre>	<pre>int8_T Kint8 = 5; . . rtb_Gain1 = rtwdemo_paramdt_U.In4 * ((real32_T)( Kint8 )); . . rtwdemo_paramdt_Y.Out4 = rt_SATURATE(rtb_Gain1, 0.0F, ((real32_T)( Kint8 )));</pre>
<p><b>Kfixpt</b></p> <pre>Kfixpt = Simulink.Parameter; Kfixpt.Value = 6; Kfixpt.DataType = ... 'fixdt(true, 16, 2^-5, 0)'; Kfixpt.CoderInfo.StorageClass = ... 'ExportedGlobal';</pre>	<pre>int16_T Kfixpt = 192; . . rtb_Gain1 = rtwdemo_paramdt_U.In5 * (((real32_T)ldexp((real_T)Kfixpt, -5))); . . rtwdemo_paramdt_Y.Out5 = rt_SATURATE(rtb_Gain1, 0.0F, (((real32_T)ldexp((real_T)Kfixpt, -5))));</pre>



Parameter & MATLAB Code	Generated Variable Declaration and Code
<p><b>Kalias</b></p> <pre>aliasType = ...   Simulink.AliasType('single'); Kalias = Simulink.Parameter; Kalias.Value = 7; Kalias.DataType = 'aliasType'; Kalias.CoderInfo.StorageClass = ...   'ExportedGlobal';</pre>	<pre>typedef real32_T aliasType; . . aliasType Kalias = 7.0F; . . rtb_Gain1 = rtwdemo_paramdt_U.In6 * Kalias; . . rtwdemo_paramdt_Y.Out6 = rt_SATURATE(rtb_Gain1, 0.0F, Kalias);</pre>
<p><b>Kuser</b></p> <pre>userType = Simulink.NumericType; userType.DataTypeMode = ...   'Fixed-point: slope and bias scaling'; userType.Slope = 2^-3; userType.isAlias = true; Kuser = Simulink.Parameter; Kuser.Value = 8; Kuser.DataType = 'userType'; Kuser.CoderInfo.StorageClass = ...   'ExportedGlobal';</pre>	<pre>typedef int16_T userType; . . userType Kuser = 64; . . rtb_Gain1 = rtwdemo_paramdt_U.In7 *   (((real32_T)1dexp((real_T)Kuser, -3))); . . rtwdemo_paramdt_Y.Out7 = rt_SATURATE(rtb_Gain1, 0.0F,   (((real32_T)1dexp((real_T)Kuser, -3))));</pre>

The salient features of the code generated for this model are as follows:

- The Simulink Coder product inlines nontunable parameters, for example, `Kinline`. However, the product does not inline tunable parameters, such as `Kcs`, `Ksingle`, and `Kint8`.
- The Simulink engine treats tunable parameters of data type `double` in a context-sensitive manner, such that the parameter inherits its data type from the context in which the block uses it. For example, `Kcs` inherits a `single` data type from the Gain block's input signal.

- If a parameter's data type matches that of the block's run-time parameter, the block can use the tunable parameter without any transformation. Consequently, the Simulink Coder product need not cast the parameter from one data type to another, as illustrated by `Ksingle` and `Kalias`. However, if a parameter's data type does not match that of the block's run-time parameter, the block cannot readily compute its output. In this case, the product casts parameters to the relevant data type. For example, `Kint8`, `Kfixpt`, and `Kuser` require casts to a single data type for compatibility with the input signals to the Gain and Saturation blocks.
- If you are using an ERT target and a parameter specifies a data type alias, for example, created by an instance of the `Simulink.AliasType` class, its variable definition in the generated code uses the alias data type. For example, the Simulink Coder product declares `Kalias` and `Kuser` to be of data types `aliasType` and `userType`, respectively.
- If a parameter specifies a fixed-point data type, the Simulink Coder product initializes its value in the generated code to the value of  $Q$  computed from the expression  $V = SQ + B$  (see the Simulink Fixed Point documentation for more information about fixed-point semantics and notation), where
  - $V$  is a real-world value
  - $Q$  is an integer that encodes  $V$
  - $S$  is the slope
  - $B$  is the bias

For example, `Kfixpt` has a real-world value of 6, slope of  $2^{-5}$ , and bias of 0. Consequently, the product declares the value of `Kfixpt` to be 192.

## Tunable Workspace Parameter Data Type Considerations

If you are using tunable workspace parameters, you need to be aware of potential issues regarding data types. A workspace parameter is tunable when the following conditions exist:

- You select the **Inline parameters** option on the **Optimization > Signals and Parameters** pane of the Configuration Parameters dialog box
- The parameter has a storage class other than `Auto`

When generating code for tunable workspace parameters, the Simulink Coder product checks and compares the data types used for a particular parameter in the workspace and in Block Parameter dialog boxes.

If...	The Simulink Coder Product...
The data types match	Uses that data type for the parameter in the generated code.
You do not explicitly specify a data type other than <code>double</code> in the workspace	<p>Uses the data type specified by the block in the generated code. If multiple blocks share a parameter, they must all specify the same data type. If the data type varies between blocks, the product generates an error similar to the following:</p> <pre>Variable 'K' is used in incompatible ways in the dialog fields of the following: cs_params/Gain, cs_params/Gain1. The variable'value is being used both directly and after a transformation. Only one of these usages is permitted for any given variable.</pre>
You explicitly specify a data type other than <code>double</code> in the workspace	Uses the data type from the workspace for the parameter. The block typecasts the parameter to the block specific data type before using it.

### Guidelines for Specifying Data Types

The following table provides guidelines on specifying data types for tunable workspace parameters.

If You Want to...	Then Specify Data Types in...
Minimize memory usage ( <code>int8</code> instead of <code>single</code> )	The workspace explicitly
Avoid typecasting	Blocks only

<b>If You Want to...</b>	<b>Then Specify Data Types in...</b>
Interface to legacy or custom code	The workspace explicitly
Use the same parameter for multiple blocks that specify different data types	The workspace explicitly

The Simulink Coder product enforces limitations on the use of data types other than `double` in the workspace, as explained in “Limitations on Specifying Workspace Data Types Explicitly” on page 15-135.

### **Limitations on Data Type Specifications in Workspace**

When you explicitly specify a data type other than `double` in the workspace, blocks typecast the parameter to a corresponding data type. This is an issue for blocks that use pointer access for their parameters. Blocks cannot use pointer access if they need to typecast the parameter before using it (because of a data type mismatch). Another case in which this occurs is for workspace variables with bias or fractional slope. Two possible solutions to these problems are

- Remove the explicit data type specification in the workspace for parameters used in such blocks.
- Modify the block so that it uses the parameter with the same data type as specified in the workspace. For example, the Lookup Table block uses the data types of its input signal to determine the data type that it uses to access the X-breakpoint parameter. You can prevent the block from typecasting the run-time parameter by converting the input signal to the data type used for X-breakpoints in the workspace. (Similarly, the output signal is used to determine the data types used to access the lookup table Y data.)

## **Tune Parameters**

### **Tune Parameters from the Command Line**

When parameters are MATLAB workspace variables, the Model Parameter Configuration dialog box is the recommended way to see or set the properties

of tunable parameters. In addition to that dialog box, you can also use MATLAB `get_param` and `set_param` commands.

---

**Note** You can also use `Simulink.Parameter` objects for tunable parameters. See “Configure Parameter Objects for Code Generation” on page 7-39 for details.

---

The following commands return the tunable parameters and corresponding properties:

- `get_param(gcs, 'TunableVars')`
- `get_param(gcs, 'TunableVarsStorageClass')`
- `get_param(gcs, 'TunableVarsTypeQualifier')`

The following commands declare tunable parameters or set corresponding properties:

- `set_param(gcs, 'TunableVars', str)`

The argument `str` (string) is a comma-separated list of variable names.

- `set_param(gcs, 'TunableVarsStorageClass', str)`

The argument `str` (string) is a comma-separated list of storage class settings.

The valid storage class settings are

- `Auto`
  - `ExportedGlobal`
  - `ImportedExtern`
  - `ImportedExternPointer`
- `set_param(gcs, 'TunableVarsTypeQualifier', str)`

The argument `str` (string) is a comma-separated list of storage type qualifiers.

The following example declares the variable `k1` to be tunable, with storage class `ExportedGlobal` and type qualifier `const`. The number of variables and number of specified storage class settings must match. If you specify multiple variables and storage class settings, separate them with a comma.

```
set_param(gcs, 'TunableVars', 'k1')
set_param(gcs, 'TunableVarsStorageClass', 'ExportedGlobal')
set_param(gcs, 'TunableVarsTypeQualifier', 'const')
```

## Interfaces for Tuning Parameters

The Simulink Coder product includes

- Support for developing a Target Language Compiler API for tuning parameters independent of external mode. See “Parameter Functions” in the Target Language Compiler documentation for information.
- A C application program interface (API) for tuning parameters independent of external mode. See “Data Interchange Using the C API” on page 15-137 for information.
- An interface for exporting ASAP2 files, which you customize to use parameter objects. For details, see “ASAP2 Data Measurement and Calibration” on page 15-174.

## Parameter Objects

- “About Parameter Objects for Code Generation” on page 7-39
- “Use Parameter Objects for Code Generation” on page 7-39
- “Configure Parameter Objects for Code Generation” on page 7-39
- “Storage Classes and Code Generation for Parameter Objects” on page 7-40
- “Generate Code for Parameter Objects from Command Line” on page 7-41
- “Generate Code for Parameter Objects Using Model Explorer” on page 7-42
- “Parameter Object Configuration Quick Reference Diagram” on page 7-46
- “Resolve Conflicts in Parameter Object Configurations” on page 7-47

## About Parameter Objects for Code Generation

Within the class hierarchy of Simulink data objects, the Simulink product provides a class that is designed as base class for parameter storage. This topic explains how to use parameter objects in code generation.

The `CoderInfo` properties of parameter objects are used by the Simulink Coder product during code generation. These properties let you assign storage classes to the objects, thereby controlling how the generated code stores and represents parameters.

The Simulink Coder build process also writes information about the properties of parameter objects to the `model.rtw` file. This information, formatted as `Object` records, is accessible to Target Language Compiler programs. For general information on `Object` records, see “Data Object Information in `model.rtw`”.

Before using Simulink parameter objects with the Simulink Coder product, read the discussion of Simulink data objects in the Simulink documentation.

## Use Parameter Objects for Code Generation

The general procedure for using parameter objects in code generation is as follows:

- 1 Define a subclass of `Simulink.Parameter`.
- 2 Instantiate parameter objects from your subclass and set their properties from the command line or by using Model Explorer.
- 3 Use the objects as parameters within your model.
- 4 Generate code and build your target executable.

## Configure Parameter Objects for Code Generation

In configuring parameter objects for code generation, you use the following code generation and parameter object properties:

- The **Inline parameters** option (see “Parameters” on page 7-10).
- Parameter object properties:

- **Value.** The numeric value of the object, used as an initial (or inlined) parameter value in generated code.
- **Data Type.** The data type of the object. This can be any Simulink numeric data type, including a fixed-point, user-defined, or alias data type.
- **CoderInfo.StorageClass.** Controls the generated storage declaration and code for the parameter object.

Other parameter object properties (such as user-defined properties of classes derived from `Simulink.Parameter`) do not affect code generation.

---

**Note** If **Inline parameters** is off (the default), the `CoderInfo.StorageClass` parameter object property is ignored in code generation.

---

### Storage Classes and Code Generation for Parameter Objects

The Simulink Coder product generates code and storage declarations based on the `CoderInfo.StorageClass` property of the parameter object. The logic is as follows:

- If the storage class is 'Auto' (the default), the parameter object is inlined (if possible), using the `Value` property.
- For storage classes other than 'Auto', the parameter object is handled as a tunable parameter.
  - A global storage declaration is generated. You can use the generated storage declaration to make the variable visible to your hand-written code. You can also make variables declared in your hand-written code visible to the generated code.
  - The symbolic name of the parameter object is generally preserved in the generated code.

See the table in “Generate Code for Parameter Objects Using Model Explorer” on page 7-42 for examples of code generated for possible settings of `CoderInfo.StorageClass`.



## Generate Code for Parameter Objects from Command Line

In this section, the Gain block computations of the model shown in the next figure are used as an example of how the Simulink Coder build process generates code for a parameter object.

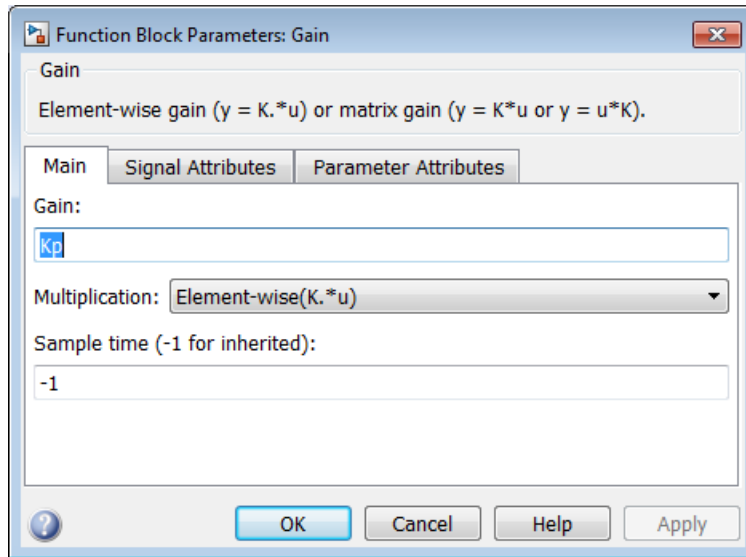

### Model Using Parameter Object Kp As Block Parameter

In this model, Kp sets the gain of the Gain block.

To configure a parameter object such as Kp for code generation:

- 1 Instantiate a Simulink.Parameter object called Kp. In this example, the parameter object is an instance of the example class SimulinkDemos.Parameter, which is provided with the Simulink product.

```
Kp = Simulink.Parameter
Kp =
Simulink.Parameter
    Value: 5
    CoderInfo: [1x1 Simulink.ParamCoderInfo]
    Description: ''
    DataType: 'auto'
```

```
Min: []  
Max: []  
DocUnits: ''  
Complexity: 'real'  
Dimensions: '[1x1]'
```

Make sure that the name of the parameter object matches the desired block parameter in your model. This enables the Simulink engine to associate the parameter name with the corresponding object. In the preceding model, the Gain block parameter Kp resolves to the parameter object Kp.

- 2 Set the object properties you need. You can do this by using the Model Explorer, or you can assign properties by using MATLAB commands, as follows:

- To specify the Value property, type

```
Kp.Value = 5.0;
```

- To specify the storage class of for the parameter, set the CoderInfo.StorageClass property, for example:

```
Kp.CoderInfo.StorageClass = 'ExportedGlobal';
```

The CoderInfo parameters are now

```
Kp.CoderInfo  
Simulink.ParamCoderInfo  
StorageClass: 'ExportedGlobal'  
Alias: ''  
CustomStorageClass: 'Default'  
CustomAttributes: [1x1  
SimulinkCSC.AttribClass_Simulink_Default]
```

### **Generate Code for Parameter Objects Using Model Explorer**

If you prefer, you can create and modify attributes of parameter objects using the Model Explorer. This lets you see the attributes of a parameter in a dialog box, and alleviates the need to remember and type field names. Do the following to instantiate Kp and set its attributes from Model Explorer:

- 1 Choose **Model Explorer** from the **View** menu.

Model Explorer opens or activates if it already was open.

- 2 Select **Base Workspace** in the **Model Hierarchy** pane.

- 3 Select **Simulink Parameter** from the **Add** menu.

A new parameter named **Param** appears in the **Contents** pane.

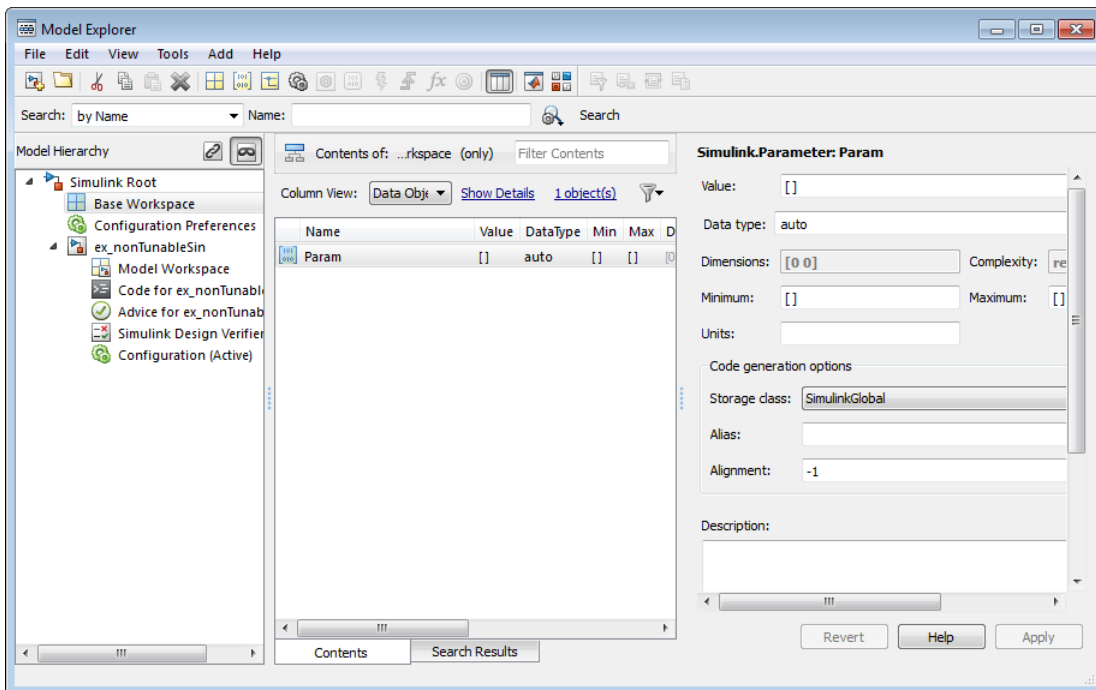

- 4 To set **Kp.Name** in the Model Explorer:
  - a Click the word **Param** in the **Name** column to select it.
  - b Rename it by typing **Kp** in place of **Param**.
  - c Press **Enter** or **Return**.
- 5 To set **Kp.Value** in Model Explorer:

- a Select the **Value** field at the top of the **Dialog** pane.
  - b Type 5.0.
  - c Click the **Apply** button.
- 6 To set the `Kp.CoderInfo.StorageClass` in Model Explorer:
- a Click the **Storage class** menu and select `ExportedGlobal`, as shown in the next figure.

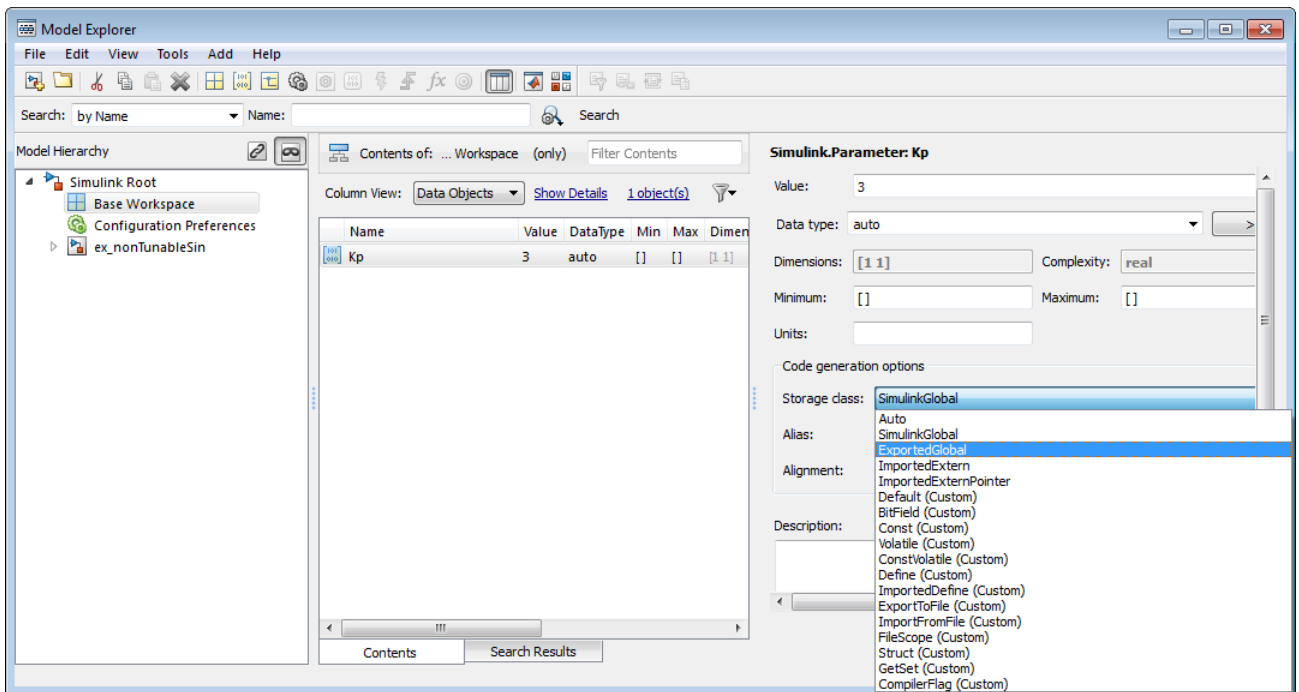

- b Click **Apply**.

The following table shows the variable declarations for `Kp` and the code generated for the Gain block in the model shown in the preceding model, with the **Inline parameters** and **Eliminate superfluous local variables (Expression folding)** check boxes selected (which includes the gain computation in the output computation). An example is shown for each

possible setting of `CoderInfo.StorageClass`. Global structures include the model name (symbolized as *model\_* or *\_model*).

<b>StorageClass Property</b>	<b>Generated Variable Declaration and Code</b>
Auto	<pre>model_Y.Out1 = rtb_u * 5.0;</pre>
SimulinkGlobal	<pre>struct _Parameters_model {     real_T Kp; } . . Parameters_model model_P = {     5.0 }; . . model_Y.Out1 = rtb_u * model_P.Kp;</pre>
ExportedGlobal	<pre>extern real_T Kp; . . real_T Kp = 5.0; . . model_Y.Out1 = rtb_u * Kp;</pre>

<b>StorageClass Property</b>	<b>Generated Variable Declaration and Code</b>
ImportedExtern	<pre>extern real_T Kp; . . model_Y.Out1 = rtb_u * Kp;</pre>
ImportedExternPointer	<pre>extern real_T *Kp; . . model_Y.Out1 = rtb_u * (*Kp);</pre>

**Parameter Object Configuration Quick Reference Diagram**

The next figure shows the code generation and storage class options that control the representation of parameter objects in generated code.

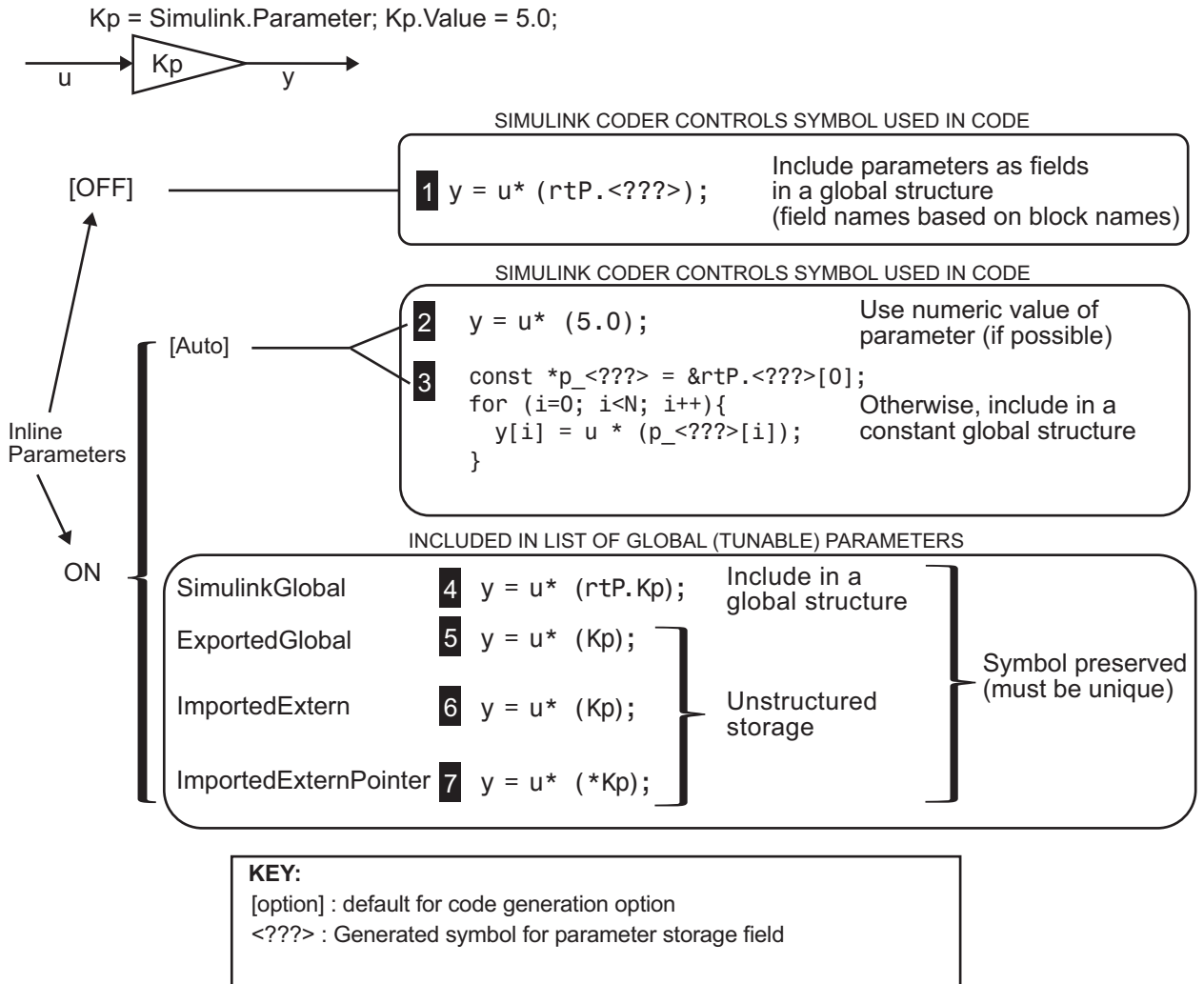

## Resolve Conflicts in Parameter Object Configurations

Two methods are available for controlling the tunability of parameters. You can

- Define them as `Simulink.Parameter` objects in the MATLAB workspace

- Use the Model Parameter Configuration dialog box

The next figures show how you can use each of these methods to control the tunability of parameter Kp. The first figure shows Kp defined as Simulink.Parameter in the Model Explorer. You control the tunability of Kp by specifying the parameter's storage class.

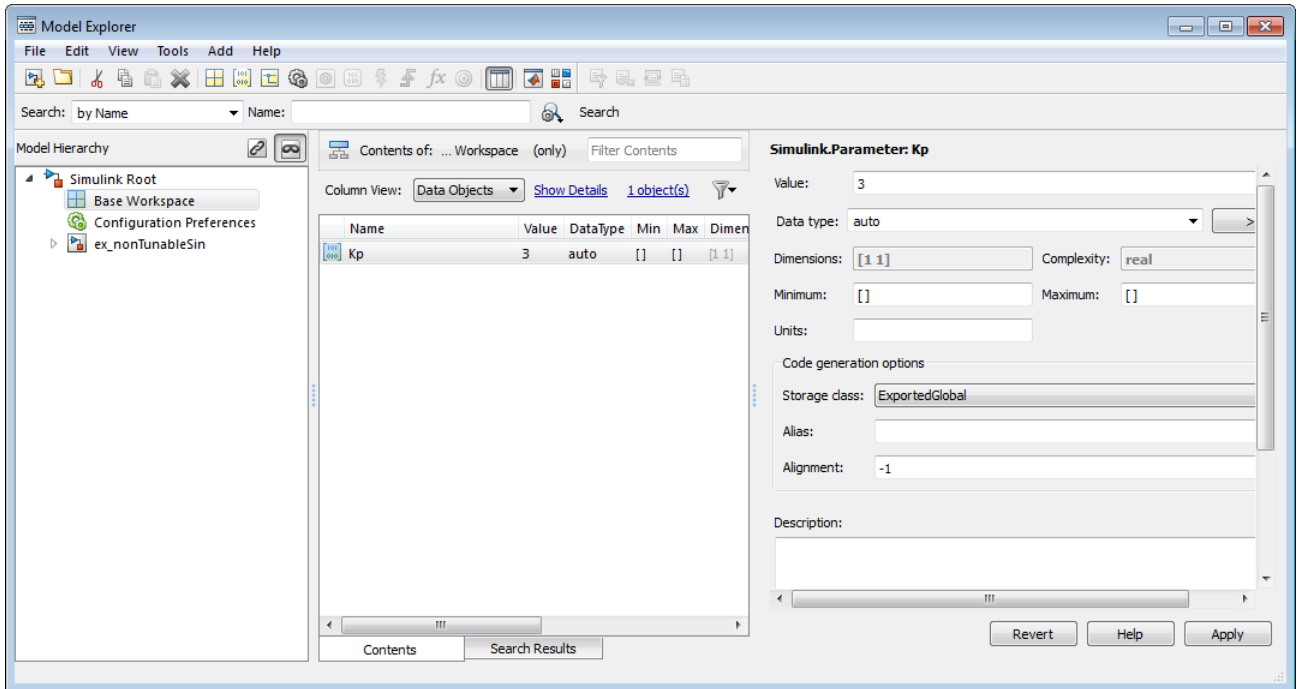

### Parameter Object Kp with Auto Storage Class in Model Explorer

The next figure shows how you can use the Model Parameter Configuration dialog box to specify a storage class for numeric variables in the MATLAB workspace.



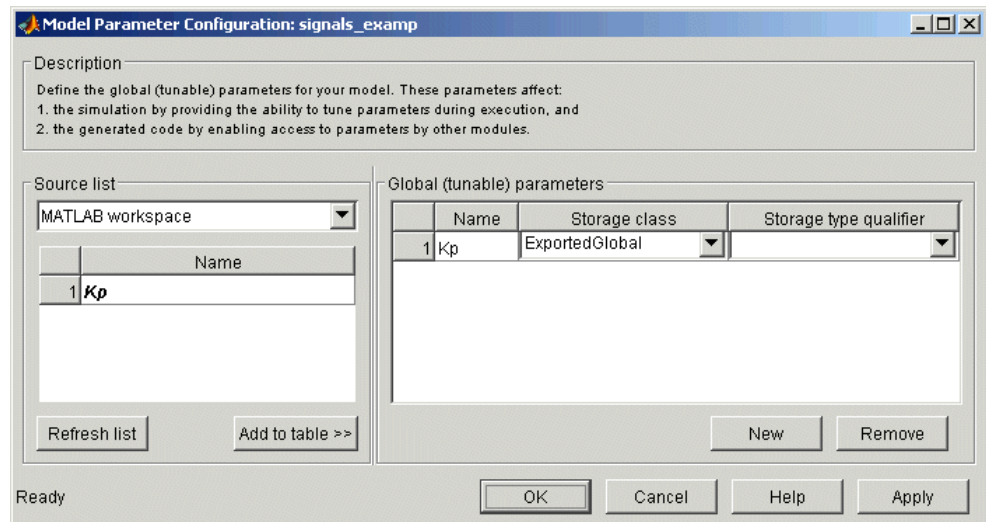

### Parameter Kp Defined with SimulinkGlobal Storage Class

**Note** Do not use both methods for controlling the tunability of a given parameter. If you use both methods and the storage class settings for the parameter do not match, an error results.

## Structure Parameters and Generated Code

- “About Structure Parameters and Generated Code” on page 7-49
- “Include Structure Parameters in Generated Code” on page 7-50
- “Control Naming of Structure Parameter Types” on page 7-50

### About Structure Parameters and Generated Code

Structure parameters provide a way to improve generated code to use structures rather multiple separate variables. You also have the option of configuring the appearance of a structure parameter in generated code.

For more information about structure parameters, see “Structure Parameters” in the Simulink documentation. For an example of how to convert a model

that uses unstructured workspace variables to a model that uses structure parameters, see `sldemo_applyVarStruct`.

### **Include Structure Parameters in Generated Code**

By default, structure parameters do not appear in generated code. Structure parameters include numeric variables and the code generator inlines numeric values.

To make structure type definition appear in generated code for a structure parameter,

- 1** Create a `Simulink.Parameter` object.
- 2** Define the object value to be the parameter structure.
- 3** Define the object storage class to be a value other than `Auto`.

The code generator places a structure type definition or the tunable parameter structure in `model_types.h`. By default, the code generator identifies the type with a nondescriptive, automatically generated name, such as `struct_z98c0D2qc4btL`.

For information on how to control the naming of the type, see “Control Naming of Structure Parameter Types” on page 7-50. For an example, see `sldemo_applyVarStruct`

### **Control Naming of Structure Parameter Types**

To control the naming of a structure parameter type, by using a `Simulink.Bus` object to specify the data type of the `Simulink.Parameter` object.

- 1** Use `Simulink.Bus.createObject` to create a bus object with the same shape as the parameter structure. For example:

```
busInfo=Simulink.Bus.createObject(ControlParam.Value);
```

- 2** Assign the bus object name to the data type property of the parameter object.

```
ParamType=eval(busInfo.busName);
```

```
ControlParam.DataType='Bus: ParamType';
```

Only `Simulink.Parameter` can accept the bus object name as a data type.

For an example, see `sldemo_applyVarStruct`

## Signals

### In this section...

- “About Signals” on page 7-52
- “Signal Storage Concepts” on page 7-53
- “Signals with Auto Storage Class” on page 7-55
- “Signals with Test Points” on page 7-59
- “Interface Signals to External Code” on page 7-60
- “Symbolic Naming Conventions for Signals” on page 7-62
- “Summary of Signal Storage Class Options” on page 7-63
- “Interfaces for Monitoring Signals” on page 7-64
- “Signal Objects” on page 7-65
- “Initialize Signals and States Using Signal Objects” on page 7-74

### About Signals

The Simulink Coder product offers a number of options that let you control how signals in your model are stored and represented in the generated code. This section discusses how you can use these options to

- Control whether signal storage is declared in global memory space or locally in functions (that is, in stack variables).
- Control the allocation of stack space when using local storage.
- Declare signals as *test points* to store them in unique memory locations
- Reduce memory usage by instructing the Simulink Coder product to store signals in reusable buffers.
- Control whether or not signals declared in generated code are interfaceable (visible) to externally written code. You can also specify that signals are to be stored in locations declared by externally written code.
- Preserve the symbolic names of signals in generated code by using signal labels.

The discussion in the following sections refers to code generated from `signal_examp`, the model shown in the next figure.

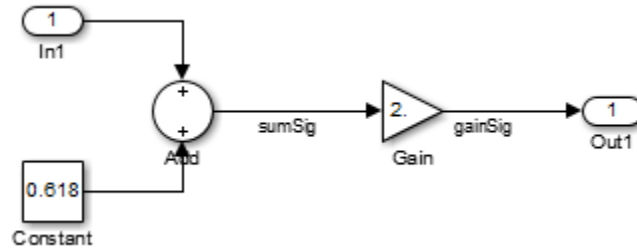

### Signal\_examp Model

## Signal Storage Concepts

This section discusses structures and concepts you must understand to choose the best signal storage options for your application:

- The global block I/O data structure `model_B`
- The concept of signal *storage classes* as used in the Simulink Coder product

## Global Block I/O Structure

By default, the Simulink Coder product attempts to optimize memory usage by sharing signal memory and using local variables.

However, under a number of circumstances you should place signals in global memory. For example,

- You might want a signal to be stored in a structure that is visible to externally written code.
- The number and/or size of signals in your model might exceed the stack space available for local variables.

In such cases, it is possible to override the default behavior and store selected (or all) signals in a model-specific *global block I/O data structure*. The global block I/O structure is called `model_B` (in earlier versions this was called `rtB`).

The following code shows how *model\_B* is defined and declared in code generated (with signal storage optimizations off) from the *signal\_exam* model shown in the *Signal\_exam* Model on page 7-53 figure.

```
(in signal_exam.h)
/* Block signals (auto storage) */
extern BlockIO_signal_exam signal_exam_B;
```

```
(in signal_exam.c)
/* Block signals (auto storage) */
BlockIO_signal_exam signal_exam_B;
```

Field names for signals stored in *model\_B* are generated according to the rules described in “Symbolic Naming Conventions for Signals” on page 7-62.

### Signals Storage Classes

In the Simulink Coder product, the *storage class* property of a signal specifies how the product declares and stores the signal. In some cases this specification is qualified by more options.

In the context of the Simulink Coder product, the term “storage class” is not synonymous with the term *storage class specifier*, as used in the C language.

**Default Storage Class.** Auto is the default storage class and is the storage class you should use for signals that you do not need to interface to external code. Signals with Auto storage class can be stored in local and/or shared variables or in a global data structure. The form of storage depends on the **Signal storage reuse**, **Reuse block outputs**, **Enable local block outputs**, and **Minimize data copies between local and global variables** options, and on available stack space. See “Signals with Auto Storage Class” on page 7-55 for a full description of code generation options for signals with Auto storage class.

**Explicitly Assigned Storage Classes.** Signals with storage classes other than Auto are stored either as members of *model\_B*, or in unstructured global variables, independent of *model\_B*. These storage classes are for signals that you want to monitor and/or interface to external code.

The **Signal storage reuse**, **Enable local block outputs**, **Reuse block outputs**, **Eliminate superfluous local variables (expression folding)**, and **Minimize data copies between local and global variables** optimizations do not apply to signals with storage classes other than Auto.

Use the Signal Properties dialog box to assign these storage classes to signals:

- **SimulinkGlobal (Test Point)**: Test points are stored as fields of the *model\_B* structure that are not shared or reused by any other signal. See “Signals with Test Points” on page 7-59 for more information.
- **ExportedGlobal**: The signal is stored in a global variable, independent of the *model\_B* data structure. *model.h* exports the variable. Signals with ExportedGlobal storage class must have unique signal names. See “Interface Signals to External Code” on page 7-60 for more information.
- **ImportedExtern**: *model\_private.h* declares the signal as an extern variable. Your code must supply the variable definition. Signals with ImportedExtern storage class must have unique signal names. See “Interface Signals to External Code” on page 7-60 for more information.
- **ImportedExternPointer**: *model\_private.h* declares the signal as an extern pointer. Your code must define a valid pointer variable. Signals with ImportedExtern storage class must have unique signal names. See “Interface Signals to External Code” on page 7-60 for more information.

## Signals with Auto Storage Class

Options are available for signals with Auto storage class:

- **Signal storage reuse**
- **Enable local block outputs**
- **Reuse block outputs**
- **Eliminate superfluous local variables (expression folding)**
- **Minimize data copies between local and global variables**

Use these options to control signal memory reuse and choose local or global (*model\_B*) storage for signals. The **Signal storage reuse** option is on the **Optimization > Signals and Parameters** pane of the Configuration Parameters dialog box, as shown in the next figure.

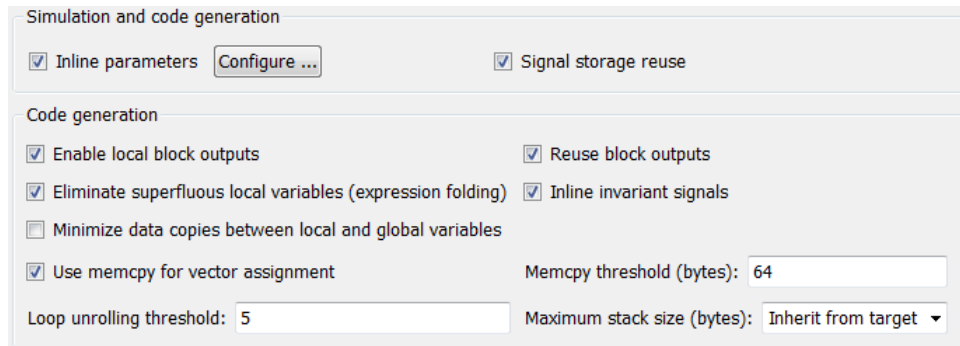

These options interact. When the **Signal storage reuse** option is selected,

- The **Reuse block outputs** option is enabled and selected, and signal memory is reused.
- The **Enable local block outputs** option is enabled and selected. This lets you choose whether reusable signal variables are declared as local variables in functions or as members of *model\_B*.
- The **Eliminate superfluous local variables (expression folding)** is enabled and selected, and block computations collapse into single expressions.
- The **Minimize data copies between local and global variables** is enabled and cleared, and global memory is not reused.

The following code examples illustrate the effects of the **Signal storage reuse**, **Enable local block outputs**, **Reuse block outputs**, **Eliminate superfluous local variables (expression folding)** and **Minimize data copies between local and global variables** options. The examples were generated from the *signal\_examp* model (see figure *Signal\_examp Model* on page 7-53).

The first example illustrates signal storage optimization, with **Signal storage reuse**, **Enable local block outputs**, **Reuse block outputs**, and **Minimize data copies between local and global variables** selected. (For clarity in showing the individual Gain and Sum block computation, expression folding is off in this example.) The output signal from the Sum block reuses *signal\_examp\_Y.Out1*, a variable local to the model output function.



```

/* Model output function */
static void signal_examp_output(int_T tid)
{
    /* Sum: '<Root>Sum' incorporates:
     * Constant: '<Root>/Constant'
     * Inport: '<Root>>/In1'
     */
    signal_examp_Y.Out1 = signal_examp_U.In1 + signal_examp_P.Constant_Value;

    /* Gain: '<Root>/Gain' */
    signal_examp_Y.Out1 = signal_examp_P.Gain_Gain * signal_examp_Y.Out1;

    /* tid is required for a uniform function interface.
     * Argument tid is not used in the function. */
    UNUSED_PARAMETER(tid);
}

```

If you are constrained by limited stack space, you can turn **Enable local block outputs** off and still benefit from memory reuse. The following example was generated with **Enable local block outputs** cleared and **Signal storage reuse**, **Reuse block outputs**, and **Minimize data copies between local and global variables** selected. The output signals from the Sum and Gain blocks use global structure `signal_examp_B` rather than declaring local variables and in both cases the signal name is `gainSig`.

```

/* Model output function */
static void signal_examp_output(int_T tid)
{
    /* Sum: '<Root>/Add' incorporates:
     * Constant: '<Root>/Constant'
     * Inport: '<Root>/In1'
     */
    signal_examp_B.gainSig = signal_examp_U.In1 +
        signal_examp_P.Constant_Value;

    /* Gain: '<Root>/Gain' */
    signal_examp_B.gainSig = signal_examp_P.Gain_Gain *
        signal_examp_B.gainSig;

    /* Outport: '<Root>/Out1' */
}

```

```
    signal_examp_Y.Out1 = signal_examp_B.gainSig;

    /* tid is required for a uniform function interface.
     * Argument tid is not used in the function. */
    UNUSED_PARAMETER(tid);
}

```

When the **Signal storage reuse** option is cleared, **Reuse block outputs**, **Enable local block outputs**, and **Minimize data copies between local and global variables** are disabled. This makes the block output signals global and unique, `signal_examp_B.sumSig` and `signal_examp_B.gainSig`, as shown in the following code.

```
/* Model output function */
static void signal_examp_output(int_T tid)
{
    /* Sum: '<Root>/Add' incorporates:
     * Constant: '<Root>/Constant'
     * Inport: '<Root>/In1'
     */
    signal_examp_B.sumSig = signal_examp_U.In1 +
        signal_examp_P.Constant_Value;

    /* Gain: '<Root>/Gain' */
    signal_examp_B.gainSig = signal_examp_P.Gain_Gain *
        signal_examp_B.sumSig;

    /* Output: '<Root>/Out1' */
    signal_examp_Y.Out1 = signal_examp_B.gainSig;

    /* tid is required for a uniform function interface.
     * Argument tid is not used in the function. */
    UNUSED_PARAMETER(tid);
}

```

In large models, disabling **Signal storage reuse** can significantly increase RAM and ROM usage. Therefore, this approach is not recommended for code deployment; however it can be useful in rapid prototyping environments.

The following table summarizes the possible combinations of the **Signal storage reuse / Reuse block outputs** and **Enable local block outputs** options.

	<b>Signal storage reuse and Reuse block outputs ON</b>	<b>Signal storage reuse OFF (Reuse block outputs disabled)</b>
<b>Enable local block outputs ON</b>	Reuse signals in local memory (fully optimized)	N/A
<b>Enable local block outputs OFF</b>	Reuse signals in <i>model_B</i> structure	Individual signal storage in <i>model_B</i> structure

### Control Stack Space Allocation

The value of the “Maximum stack size (bytes)” parameter, on the **Optimization > Signals and Parameters** pane of the Configuration Parameters dialog box constrains the use of stack space used by local block output variables. The command-line equivalent for this parameter is `MaxStackSize`. If the accumulated size of variables in local memory exceeds `MaxStackSize`, the product places subsequent local variables in global memory space.

If it is important that you maximize potential for signal storage optimization, then set `MaxStackSize` to accommodate the size and number of signals in your model. This minimizes overflow into global memory space and maximizes use of local memory. Local variables offer more optimization potential through mechanisms such as expression folding and buffer reuse. See “Use Stack Space Allocation” on page 20-6 for more information.

### Signals with Test Points

A *test point* is a signal that is stored in a unique location no other signals share or reuse. See “Test Points” in the Simulink documentation for information about including test points in your model.

When you generate code for models that include test points, the Simulink Coder build process allocates a separate memory buffer for each test point. Test points are stored as members of the *model\_B* structure.

Declaring a signal as a test point disables the following options for that signal. This can lead to increased code and data size. You do not lose the benefits of optimized storage for any other signals in your model.

- **Signal storage reuse**
- **Enable local block outputs**
- **Reuse block outputs**
- **Eliminate superfluous local variables (expression folding)**
- **Minimize data copies between local and global variables**

For an example of storage declarations and code generated for a test point, see “Summary of Signal Storage Class Options” on page 7-63.

If you have an Embedded Coder license, you can specify that the Simulink Coder build process ignore test points in the model, allowing optimal buffer allocation, using the “Ignore test point signals” parameter. Ignoring test points facilitates transitioning from prototyping to deployment and avoids accidental degradation of generated code due to workflow artifacts. For more information, see “Ignore test point signals”.

### Interface Signals to External Code

The Simulink Signal Properties dialog box lets you interface selected signals to externally written code. In this way, your hand-written code has access to such signals for monitoring or other purposes. To interface a signal to external code, use the **Code Generation** tab of the Signal Properties dialog box to assign one of the following storage classes to the signal:

- `ExportedGlobal`
- `ImportedExtern`
- `ImportedExternPointer`

Set the storage class as follows:

- 1 In your Simulink block diagram, select the line that carries the signal. Then select **Signal Properties** from the **Edit** menu of your model. This opens the Signal Properties dialog box. Alternatively, right-click the line that carries the signal, and select **Signal properties** from the menu.
- 2 Select the **Code Generation** tab of the Signal Properties dialog box.
- 3 Select the desired storage class (Auto, ExportedGlobal, ImportedExtern, or ImportedExternPointer) from the **Storage class** menu. The next figure shows ExportedGlobal selected.

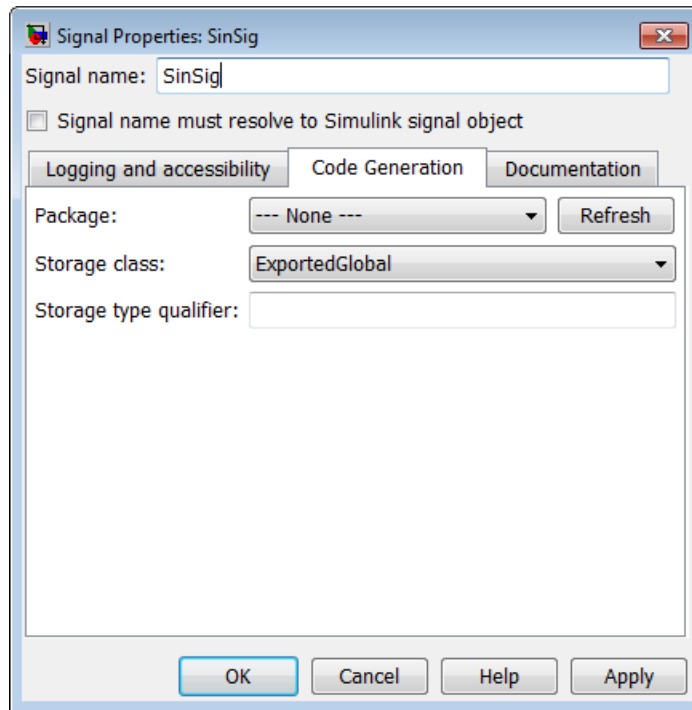

- 4 *Optional:* For storage classes other than Auto, you can enter a storage type qualifier such as `const` or `volatile` in the **Storage type qualifier** field. The Simulink Coder product does not check this string for errors; whatever you enter is included in the variable declaration.
- 5 Click **Apply**.

---

**Note** You can also interface test points and other signals that are stored as members of *model\_B* to your code. To do this, your code must know the address of the *model\_B* structure where the data is stored, and other information. This information is not automatically exported. The Simulink Coder product provides C/C++ and Target Language Compiler APIs that give your code access to *model\_B* and other data structures. See “Interfaces for Monitoring Signals” on page 7-64 for more information.

---

## Symbolic Naming Conventions for Signals

When signals have a storage class other than Auto, the Simulink Coder product preserves symbolic information about the signals or their originating blocks in the generated code.

For labeled signals, field names in *model\_B* derive from the signal names. In the following example, the field names *model\_B.sumSig* and *model\_B.gainSig* are derived from the corresponding labeled signals in the *signal\_examp* model (shown in figure *Signal\_examp Model* on page 7-53).

```
/* Block signals (auto storage) */
typedef struct _BlockIO_signal_examp {
    real_T sumSig;                /* '<Root>/Add' */
    real_T gainSig;              /* '<Root>/Gain' */
} BlockIO_signal_examp;
```

When you clear the **Signal storage reuse** optimization, *sumSig* is not part of *model\_B*, and a local variable is used for it instead. For unlabeled signals, *model\_B* field names are derived from the name of the source block or subsystem.

The components of a generated signal label are

- The root model name, followed by
- The name of the generating signal object, followed by
- A unique *name mangling* string (if required)

The number of characters that a signal label can have is limited by the **Maximum identifier length** parameter specified on the **Symbols** pane

of the Configuration Parameters dialog box. See “Configure Generated Identifiers” on page 9-73 for more detail.

When a signal has Auto storage class, the Simulink Coder build process controls generation of variable or field names without regard to signal labels.

## Summary of Signal Storage Class Options

The next table shows, for each signal storage class option, the variable declaration and the code generated for Sum (`sumSig`) and Gain (`gainSig`) block outputs of the model shown in figure Signal\_examp Model on page 7-53.

Storage Class	Declaration	Code
Auto (with <b>Signal storage reuse</b> optimizations on)	In <code>model.c</code> or <code>model.cpp</code>  <pre>real_T rtb_sumSig;</pre>	<pre>rtb_sumSig = signal_examp_U.In1 +   signal_examp_P.Constant_Value; rtb_sumSig *=   signal_examp_P.Gain_Gain; signal_examp_Y.Out1 = rtb_sumSig;</pre>
Test point (for <code>sumSig</code> only)	In <code>model.h</code>  <pre>typedef struct _BlockIO_signal_examp {   real_T sumSig; } BlockIO_signal_examp;</pre> In <code>model.c</code> or <code>model.cpp</code>  <pre>BlockIO_signal_examp signal_examp_B; real_T rtb_gainSig;</pre>	<pre>signal_examp_B.sumSig =   signal_examp_U.In1 +   signal_examp_P.Constant_Value; rtb_gainSig =   signal_examp_B.sumSig *   signal_examp_P.Gain_Gain; signal_examp_Y.Out1 = rtb_gainSig;</pre>

Storage Class	Declaration	Code
ExportedGlobal (for sumSig only)	In <i>model.h</i>  extern real_T sumSig;  In <i>model.c</i> or <i>model.cpp</i>  real_T sumSig; real_T rtb_gainSig;	sumSig = signal_examp_U.In1 + signal_examp_P.Constant_Value; rtb_gainSig = sumSig * signal_examp_P.Gain_Gain; signal_examp_Y.Out1 = rtb_gainSig;
ImportedExtern	In <i>model_private.h</i>  extern real_T sumSig;  In <i>model.c</i> or <i>model.cpp</i>  real_T rtb_gainSig;	sumSig = signal_examp_U.In1 + signal_examp_P.Constant_Value; rtb_gainSig = sumSig * signal_examp_P.Gain_Gain; signal_examp_Y.Out1 = rtb_gainSig;
ImportedExternPointer	In <i>model_private.h</i>  extern real_T *sumSig;  In <i>model.c</i> or <i>model.cpp</i>  real_T rtb_gainSig;	(*sumSig) = signal_examp_U.In1 + signal_examp_P.Constant_Value; rtb_gainSig = (*sumSig) * signal_examp_P.Gain_Gain; signal_examp_Y.Out1 = rtb_gainSig;

## Interfaces for Monitoring Signals

The Simulink Coder product includes

- Support for developing a Target Language Compiler API for monitoring signals and states independent of external mode. See “Input Signal Functions” and “Output Signal Functions” in the Target Language Compiler documentation for information.
- A C application program interface (API) for monitoring signals and states independent of external mode. See “Data Interchange Using the C API” on page 15-137 for information.



- An interface for exporting ASAP2 files, which you customize to use signal objects. For details, see “ASAP2 Data Measurement and Calibration” on page 15-174.

## Signal Objects

- “About Signal Objects for Code Generation” on page 7-65
- “Use Signal Objects for Code Generation” on page 7-66
- “Configure Signal Objects for Code Generation” on page 7-66
- “Storage Classes and Code Generation for Signal Objects” on page 7-66
- “Generate Code for Signal Objects from Command Line” on page 7-67
- “Generate Code for Signal Objects Using Model Explorer” on page 7-69
- “Resolve Conflicts in Configuration of Signals Objects” on page 7-72

This section discusses how to use signal objects in code generation. Signal objects can be used to represent both signal and state data, and behave similarly to parameter objects, described in “Parameter Objects” on page 7-38.

### About Signal Objects for Code Generation

Within the class hierarchy of Simulink data objects, the Simulink product provides a class that is designed as base class for signal storage. This topic explains how to use signal objects in code generation.

The `CoderInfo` properties of signal objects are used by the Simulink Coder product during code generation. These properties let you assign storage classes to the objects, thereby controlling how the generated code stores and represents signals.

The Simulink Coder build process also writes information about the properties of signal objects to the `model.rtw` file. This information, formatted as `Object` records, is accessible to Target Language Compiler programs. For general information on `Object` records, see “Data Object Information in `model.rtw`”.

Before using Simulink signal objects with the Simulink Coder product, read the discussion of Simulink data objects in the Simulink documentation.

## Use Signal Objects for Code Generation

The general procedure for using signal objects in code generation is as follows:

- 1 Define a subclass of `Simulink.Signal`.
- 2 Instantiate signal objects from your subclass and set their properties from the command line or by using Model Explorer.
- 3 Use the objects as signals within your model.
- 4 Generate code and build your target executable.

## Configure Signal Objects for Code Generation

In configuring signal objects for code generation, you use the following code generation options and signal object properties:

- The **Signal storage reuse** code generation option (see “Signals” on page 7-52).
- The **Enable local block outputs** code generation option (see “Signals” on page 7-52).
- The **Minimize data copies between local and global variables** code generation option (see “Signals” on page 7-52).
- The `CoderInfo.StorageClass` signal object property: The storage classes defined for signal objects, and their effect on code generation, are the same for model signals and signal objects (see “Signals Storage Classes” on page 7-54).

Other signal object properties (such as user-defined properties of classes derived from `Simulink.Signal`) do not affect code generation.

## Storage Classes and Code Generation for Signal Objects

The way in which the Simulink Coder product uses storage classes to determine how signals are stored is the same with and without signal objects. However, if a signal’s label resolves to a signal object, the object’s `CoderInfo.StorageClass` property is used in place of the port configuration of the signal.

The default storage class is Auto. If the storage type is Auto, the Simulink Coder product follows the **Signal storage reuse**, **Reuse block outputs**, **Enable local block outputs**, **Eliminate superfluous local variables (expression folding)**, and **Minimize data copies between local and global variables** code generation options to determine whether signal objects are stored in reusable and/or local variables. Make sure that these options are set for your application.

To generate a test point or signal storage declaration that can interface externally, use an explicit `CoderInfo.StorageClass` assignment. For example, setting the storage class to `SimulinkGlobal`, as in the following command, is equivalent to declaring a signal as a test point.

```
SinSig.CoderInfo.StorageClass = 'SimulinkGlobal';
```

## Generate Code for Signal Objects from Command Line

The discussion and code examples in this section refer to the model shown in the next figure.

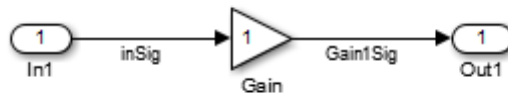

To configure a signal object, you must first create it and associate it with a labeled signal in your model. To do this,

- 1** Define a subclass of `Simulink.Signal`. In this example, the signal object is an instance of the class `Simulink.Signal`, which is provided with the Simulink product.
- 2** Instantiate a signal object from your subclass. The following example instantiates `inSig`, a signal object of class `Simulink.Signal`.

```
inSig = Simulink.Signal
inSig =
```

```
Simulink.Signal
  CoderInfo: [1x1 Simulink.SignalCoderInfo]
  Description: ''
  DataType: 'auto'
  Min: []
  Max: []
  DocUnits: ''
  Dimensions: -1
  Complexity: 'auto'
  SampleTime: -1
  SamplingMode: 'auto'
  InitialValue: ''
```

Make sure that the name of the signal object matches the label of the desired signal in your model. This enables the Simulink engine to resolve the signal label to the corresponding object. For example, in the model shown in the above figure, the signal label `inSig` would resolve to the signal object `inSig`.

- 3** You can require signals in a model to resolve to `Simulink.Signal` objects. To do this for the signal `inSig`, in the model window right-click the signal line labeled `inSig` and choose **Signal Properties** from the context menu. A Signal Properties dialog appears.

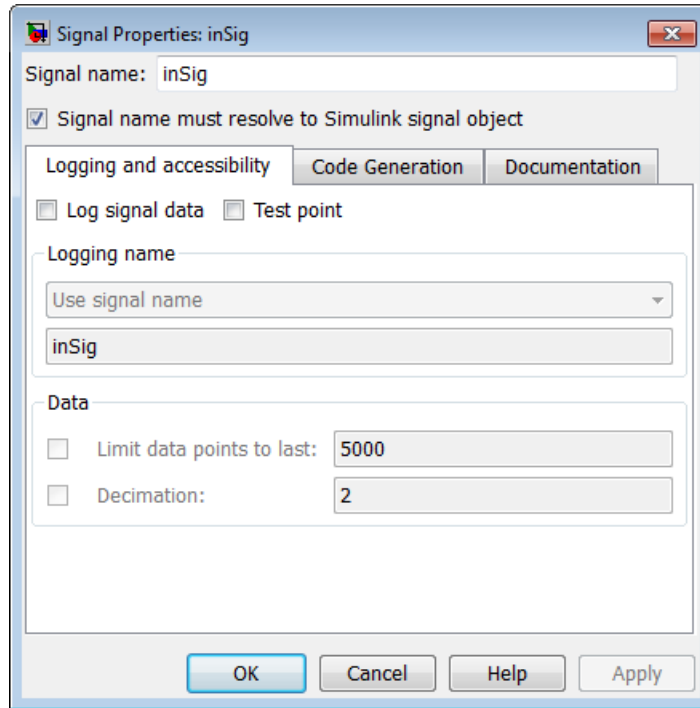

- 4** In the Signal Properties dialog box that appears, select the check box labelled **Signal name must resolve to Simulink signal object**, and click **OK** or **Apply**.
- 5** Set the object properties as required. You can do this by using the Simulink Model Explorer. Alternatively, you can assign properties by using MATLAB commands. For example, assign the signal object's storage class by setting the `CoderInfo.StorageClass` property as follows.

```
inSig.CoderInfo.StorageClass = 'ExportedGlobal';
```

### Generate Code for Signal Objects Using Model Explorer

If you prefer, you can create signal objects and modify their attributes using Model Explorer. This lets you see and set attributes of a signal in a dialog

box pane, and alleviates the need to remember and type field names. Do the following to instantiate `inSig` and set its attributes from Model Explorer:

- 1 Choose **Model Explorer** from the View menu.

Model Explorer opens or activates if it already was open.

- 2 Select **Base Workspace** in the **Model Hierarchy** pane.

- 3 Select **Simulink Signal** from the **Add** menu.

A new signal named `Sig` appears in the **Contents** pane.

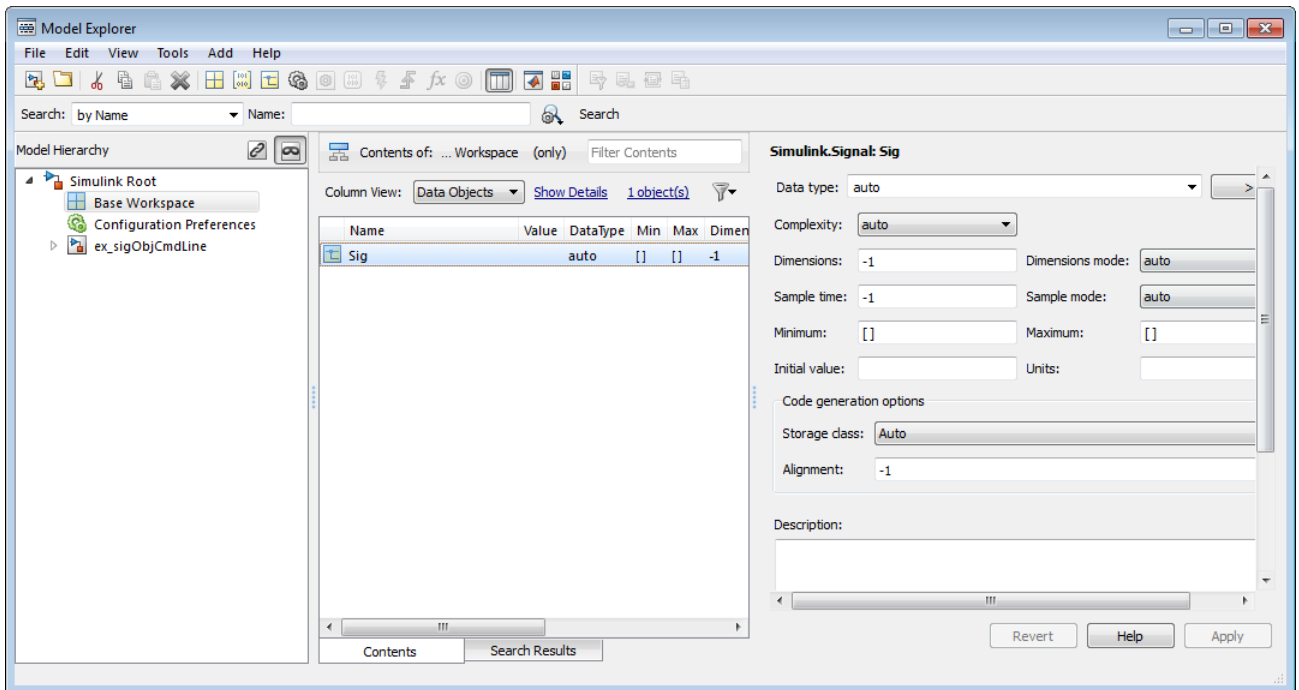

- 4 To set the signal name in Model Explorer, click the word `Sig` in the **Name** column to select it, and rename it by typing `inSig` followed by **Return** in place of `Sig`.

- 5 To set the `inSig.CoderInfo.StorageClass` in Model Explorer, click the **Storage class** menu and select `ExportedGlobal`, as shown in the next figure.

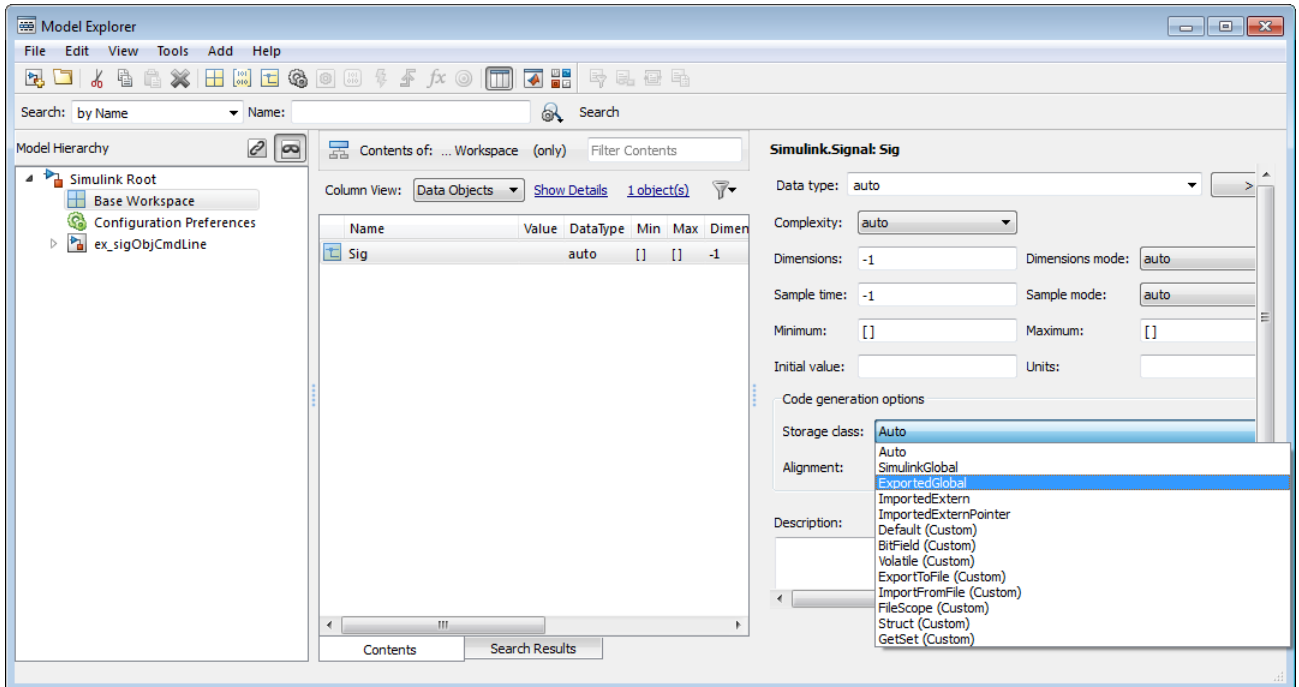

- 6 Click **Apply**.

The following table shows, for each setting of `CoderInfo.StorageClass`, the variable declaration and the code generated for the inport signal (`inSig`) of the current model:

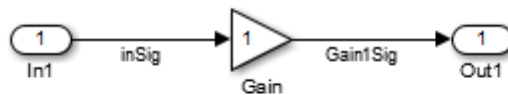

Storage Class	Declaration	Code
Auto (with storage optimizations on)	In <i>model.h</i> <pre>typedef struct _ExternalInputs_signal_objs_examp_tag {     real_T inSig; } ExternalInputs_signal_objs_examp;</pre>	<pre>rtb_Gain1Sig =     signal_objs_examp_U.inSig *     signal_objs_examp_P.Gain_Gain;</pre>
SimulinkGlobal	In <i>model.h</i> <pre>typedef struct _ExternalInputs_signal_objs_examp_tag {     real_T inSig; } ExternalInputs_signal_objs_examp;</pre>	<pre>rtb_Gain1Sig =     signal_objs_examp_U.inSig *     signal_objs_examp_P.Gain_Gain;</pre>
ExportedGlobal	In <i>model.c</i> or <i>model.cpp</i> <pre>real_T inSig;</pre> In <i>model.h</i> <pre>extern real_T inSig;</pre>	<pre>rtb_Gain1Sig = inSig *     signal_objs_examp_P.Gain_Gain;</pre>
ImportedExtern	In <i>model_private.h</i> <pre>extern real_T inSig;</pre>	<pre>rtb_Gain1Sig = inSig *     signal_objs_examp_P.Gain_Gain;</pre>
ImportedExternPointer	In <i>model_private.h</i> <pre>extern real_T *inSig;</pre>	<pre>rtb_Gain1Sig = (*inSig) *     signal_objs_examp_P.Gain_Gain;</pre>

### Resolve Conflicts in Configuration of Signals Objects

If a signal is defined in the Signal Properties dialog box and a signal object of the same name is defined by using the command line or in the Model Explorer, the potential exists for ambiguity when the Simulink engine attempts to resolve the symbol representing the signal name. One way to resolve the



ambiguity is to specify that a signal must resolve to a Simulink data object. To do this, select the **Signal name must resolve to Simulink signal object** option in the Signal Properties dialog box. When you do this, you no longer can specify the **Storage class** property in the **Code Generation** tab of the Signal Properties dialog box, as the next figure shows.

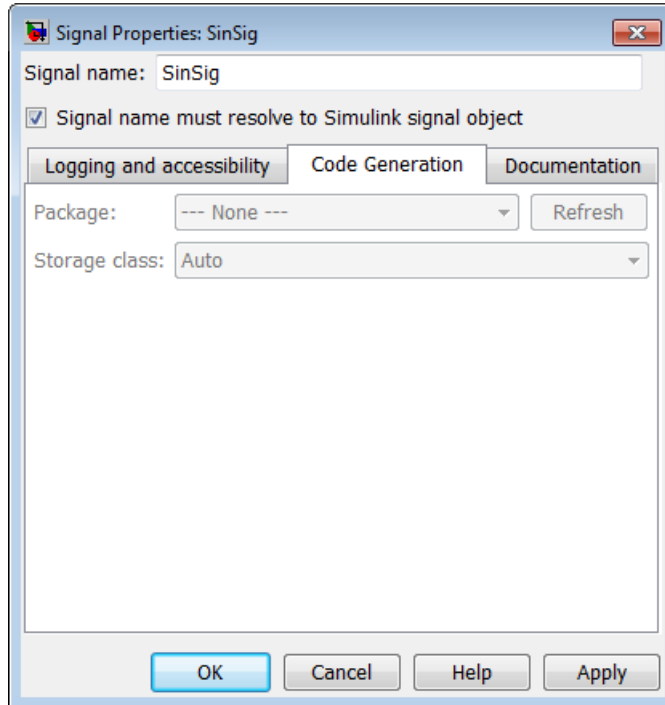

As the preceding figure shows, the **Storage class** menu is disabled because it is up to the `SinSig Simulink.Signal` object to specify its own storage class.

The signal and signal objects `SinSig` both have `SimulinkGlobal` storage class. Therefore, no conflict arises, and `SinSig` resolves to the signal object `SinSig`.

---

**Note** The rules for compatibility between block states/signal objects are identical to those given for signals/signal objects.

---

## **Initialize Signals and States Using Signal Objects**

You can use Simulink signal objects to initialize signals and discrete states with user-defined values for simulation and code generation. Data initialization increases application reliability and is a requirement of safety critical applications. Initializing signals for both simulation and code generation can expedite transitions between phases of Model-Based Design.

For details on simulation behavior, see “Initialization Behavior Summary for Signal Objects” in the Simulink documentation.

### **Specify Initial Value for Signal Object**

You can use signal objects that have a storage class other than 'auto' or 'SimulinkGlobal' to initialize

- Discrete states with an initial condition parameter
- Any signals in a model except bus signals and signals with constant sample time

The initial value is the signal or state value before a simulation takes its first time step.

---

**Note** Some initial value settings may depend on the initialization mode. For more information, see “Underspecified initialization detection”.

**Classic initialization mode:** In this mode, initial value settings for signal objects that represent the following signals and states override the corresponding block parameter initial values if undefined (specified as []):

- Output signals of conditionally executed subsystems and Merge blocks
- Block states

**Simplified initialization mode:** In this mode, initial values of signal objects associated with the output of the following blocks are ignored. The initial values of the corresponding blocks (which cannot be specified as []) are used instead.

- Output signals of conditionally executed subsystems
- Merge blocks

---

To specify an initial value, use the Model Explorer or MATLAB commands to do the following:

- 1 Create the signal object.

#### **Model Explorer**

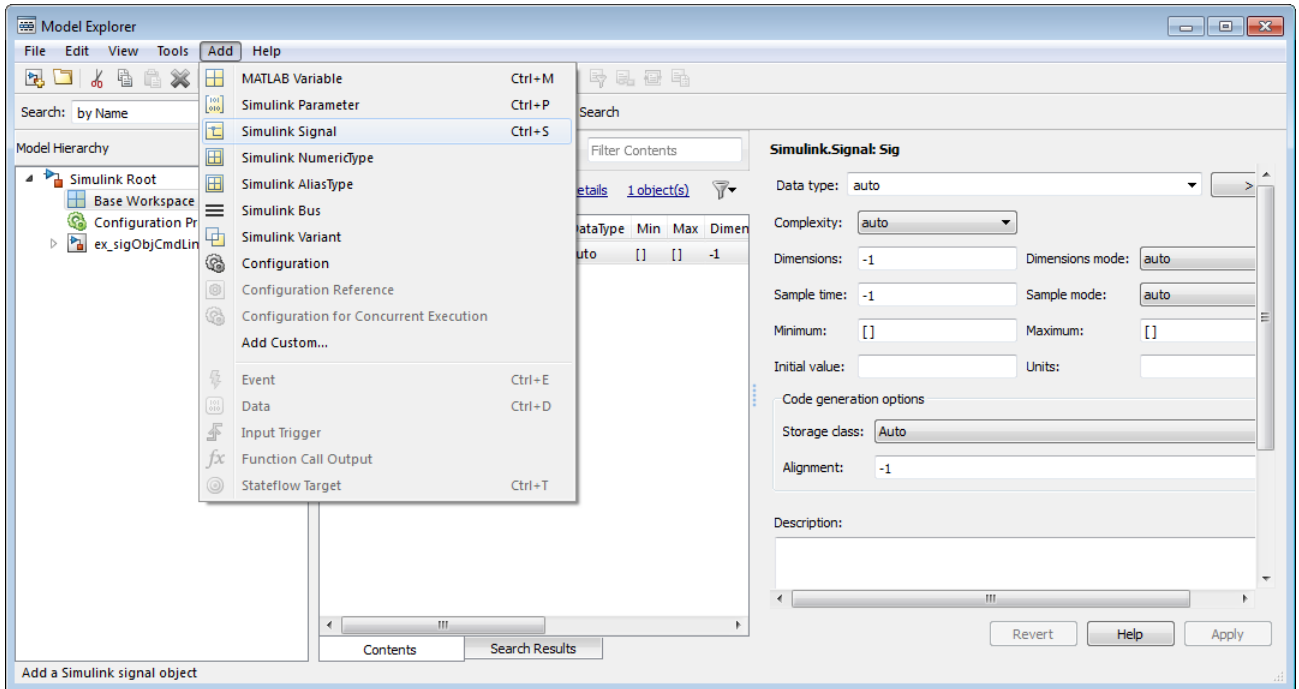

## MATLAB Command

```
S1=Simulink.Signal;
```

The name of the signal object must be the same as the name of the signal that the object is initializing. Although not required, consider setting the **Signal name must resolve to Simulink signal object** option in the Signal Properties dialog box. This setting makes signal objects in the MATLAB workspace consistent with signals that appear in your model.

Consider using the Data Object Wizard to create signal objects. The Data Object Wizard searches a model for signals for which signal objects do not exist. You can then selectively create signal objects for multiple signals listed in the search results with a single operation. For more information about the Data Object Wizard, see “Data Object Wizard” in the Simulink documentation.

- 2 Set the signal object's storage class to a value other than 'auto' or 'SimulinkGlobal'.

## Model Explorer

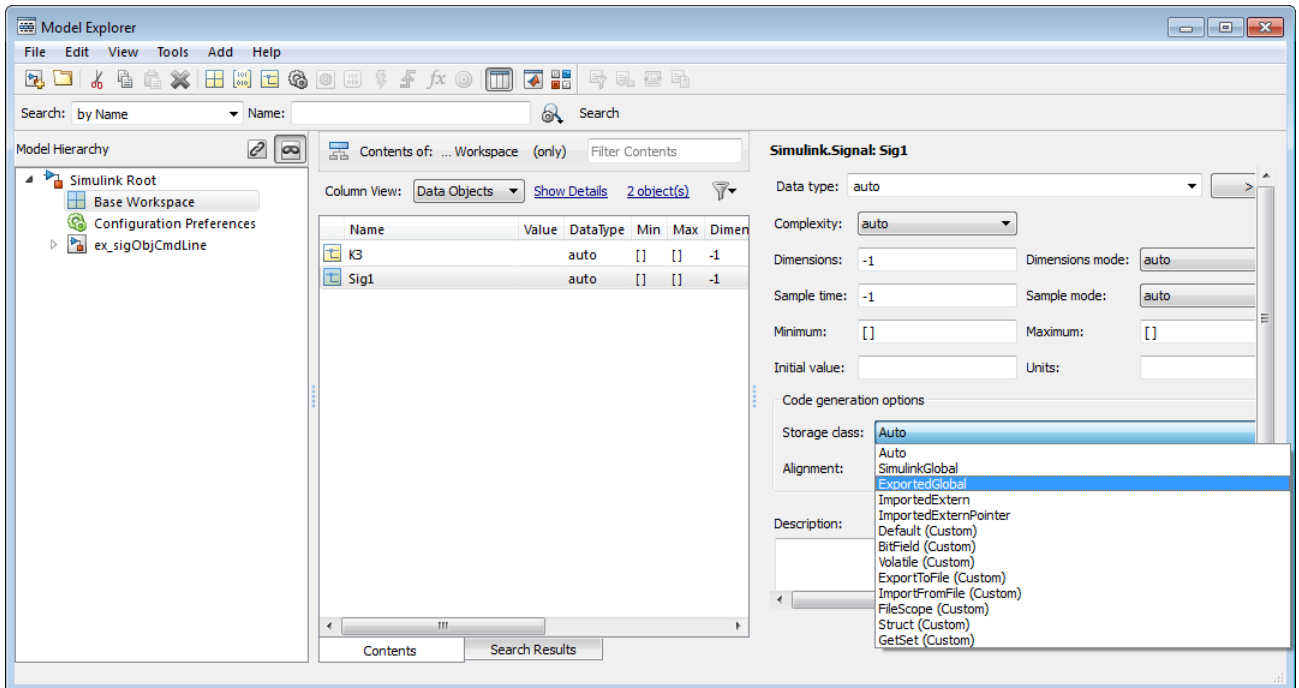

## MATLAB Command

```
S1.CoderInfo.StorageClass='ExportedGlobal';
```

- 3 Set the initial value. You can specify any MATLAB string expression that evaluates to a double numeric scalar value or array.

	<b>Model Explorer</b>	<b>MATLAB Command</b>
<b>Valid</b>	1.5 [1 2 3] 1+0.5	foo = 1.5; s1.InitialValue = 'foo';
<b>Invalid</b>	uint(1)	foo = '1.5'; s1.InitialValue = 'foo';

The Simulink engine converts the initial value so the type, complexity, and dimension are consistent with the corresponding block parameter value. If you specify an invalid value or expression, an error message appears when you update the model.

## Model Explorer

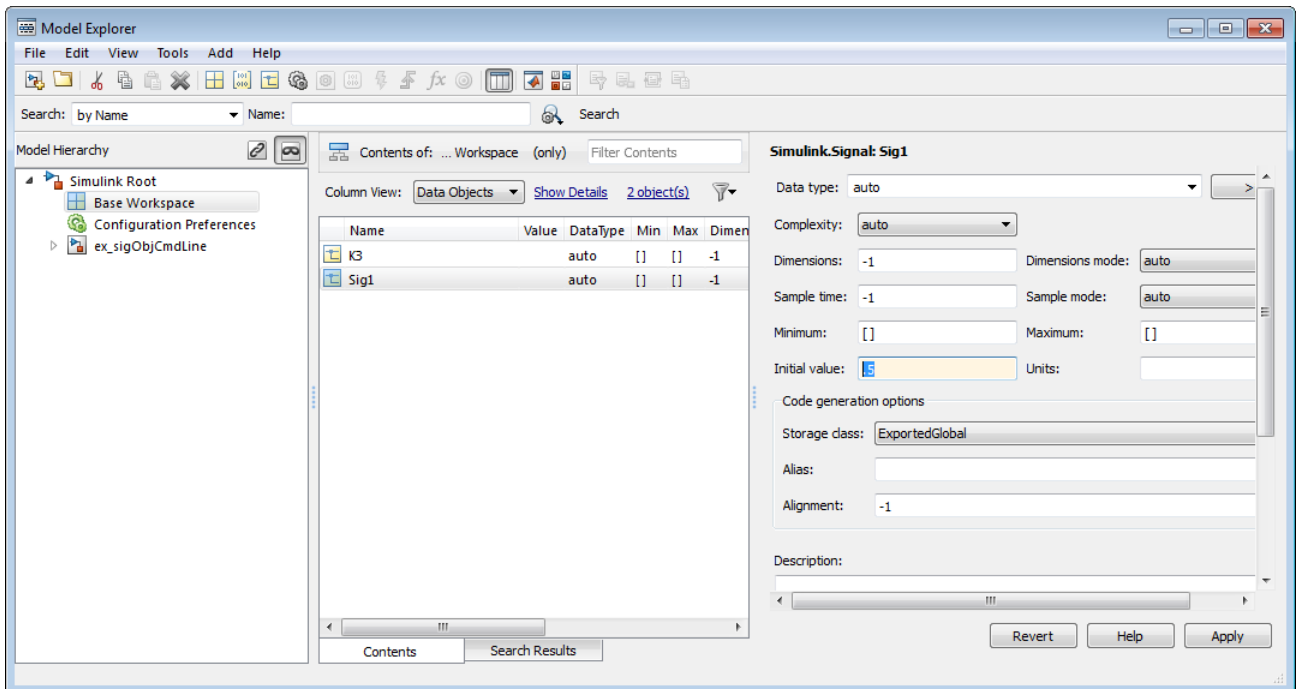

## MATLAB Command

```
S1.InitialValue='0.5'
```

The following example shows a signal object specifying the initial output of an enabled subsystem.

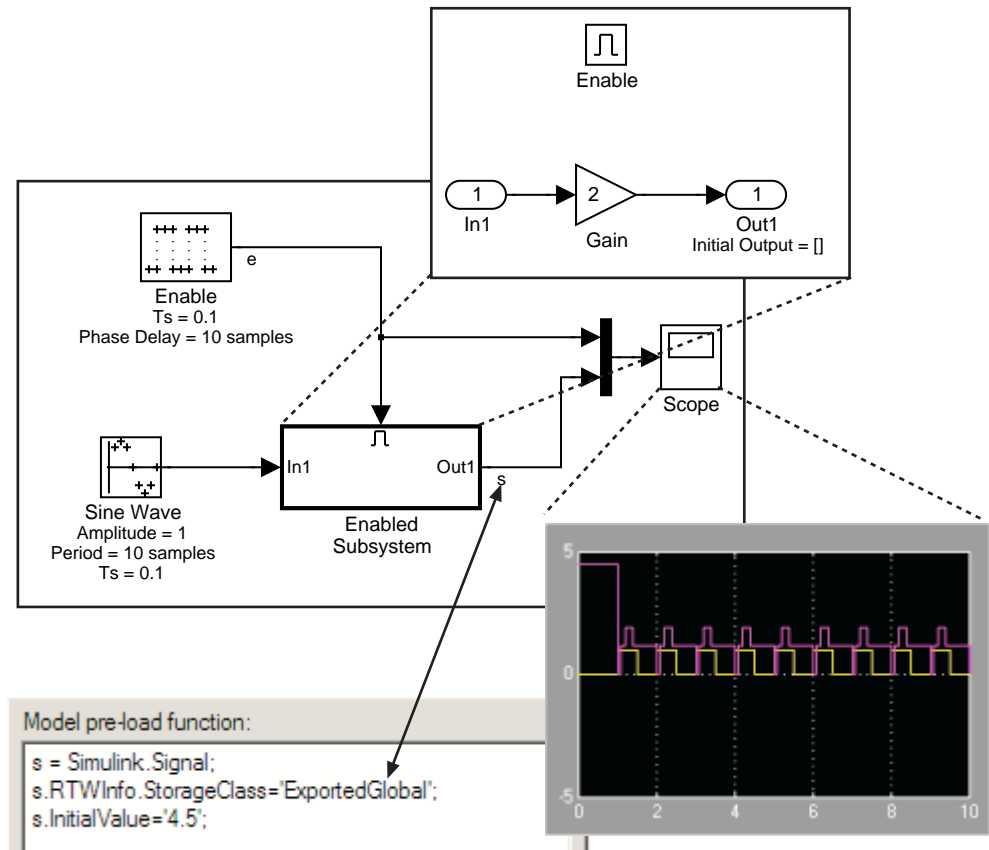

Signal `s` is initialized to 4.5. Note that to avoid a consistency error, the initial value of the enabled subsystem's Output block must be `[]` or 4.5.

### Signal Object Initialization in Generated Code

The initialization behavior for code generation is the same as that for model simulation with the following exceptions:

- RSim executables can use the **Data Import/Export** pane of the Configuration Parameters dialog box to load input values from MAT-files. GRT and ERT executables cannot load input values from MAT-files.
- The initial value for a block output signal or root level input or output signal can be overwritten by an external (calling) program.
- Setting the initial value for persistent signals is relevant if the value is used or viewed by an external application.

For details on initialization behavior for different types of signals and discrete states, see “Initialization Behavior Summary for Signal Objects” in the Simulink documentation.

When you initialize Simulink signal objects in a model during code generation, the corresponding initialization statements are placed in *model.c* or *model.cpp* in the model’s initialize code.

For example, consider the model *rtwdemo\_sigobj\_iv*.

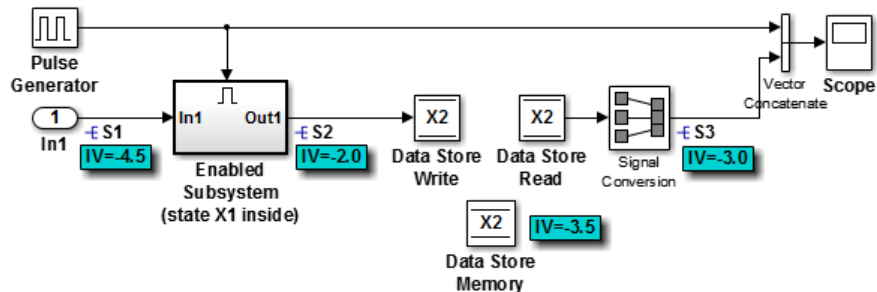

If you create and initialize signal objects in the base workspace, the Simulink Coder product places initialization code for the signals in the file *rtwdemo\_sigobj\_iv.c* under the *rtwdemo\_sigobj\_iv\_initialize* function, as shown below.

```

/* Model initialize function */

void rtwdemo_sigobj_iv_initialize(boolean_T firstTime)

{

```



```
        .
        .
        .
    /* exported global signals */
    S3 = -3.0;

    S2 = -2.0;
        .
        .
        .
    /* exported global states */
    X1 = 0.0;
    X2 = 0.0;

    /* external inputs */
    S1 = -4.5;
        .
        .
        .
```

The following code shows the initialization code for the enabled subsystem's Unit Delay block state X1 and output signal S2.

```
void MdlStart(void) {
    .
    .
    .
    /* InitializeConditions for UnitDelay: '<S2>/Unit Delay' */
    X1 = aa1;

    /* Start for enable system: '<Root>/Enabled Subsystem (state X1 inside)' */

    /* virtual outports code */

    /* (Virtual) Outport Block: '<S2>/Out1' */

    S2 = aa2;
}
}
```

Also note that for an enabled subsystem, such as the one shown in the preceding model, the initial value is also used as a reset value if the subsystem's Output block parameter **Output when disabled** is set to **reset**. The following code from `rtwdemo_sigobj_iv.c` shows the assignment statement for `S3` as it appears in the model output function `rtwdeni_sigobj_iv_output`.

```
/* Model output function */

static void rtwdemo_sigobj_iv_output(void)
{
    .
    .
    .

    /* Disable for enable system: '<Root>/Enabled Subsystem (state X1 inside)' */

    /* (Virtual) Output Block: '<S2>/Out1' */

    S2 = aa2;
```

## Tunable Initial Values

If you specify a tunable parameter in the initial value for a signal object, the parameter expression is preserved in the initialization code in `model.c`.

For example, if you configure parameter `df` to be tunable for model `signal_iv` and you initialize the signal object for discrete state `X1` with the expression `df*2`, the following initialization code appears for signal object `X1` in `signal_iv.c`.

```
void MdlInitialize(void) {

    /* InitializeConditions for UnitDelay: '<Root>/Unit Delay X1=2' */
    X1 = (tunable_param_P.df * 2.0);
}
```

For more information about the treatment of tunable parameters in generated code, see “Parameters” on page 7-10.

# States

## In this section...

- “About States” on page 7-83
- “State Storage” on page 7-83
- “State Storage Classes” on page 7-84
- “Interface States to External Code” on page 7-85
- “Symbolic Names for States” on page 7-87
- “Control Code Generation for Block States” on page 7-90
- “Summary of State Storage Class Options” on page 7-91

## About States

For certain block types, the Simulink Coder product lets you control how block states in your model are stored and represented in the generated code. Using the **State Attributes** tab of a block dialog box, you can:

- Control whether or not states declared in generated code are interfaceable (visible) to externally written code. You can also specify that states be stored in locations declared by externally written code.
- Assign symbolic names to block states in generated code.

## State Storage

The discussion of block state storage in this section applies to the following blocks:

- Discrete Filter
- Discrete PID Controller
- Discrete PID Controller (2DOF)
- Discrete State-Space
- Discrete-Time Integrator
- Discrete Transfer Function

- Discrete Zero-Pole
- Memory
- Unit Delay

These blocks require persistent memory to store values representing the state of the block between consecutive time intervals. By default, such values are stored in a *data type work vector*. This vector is usually referred to as the DWork vector. It is represented in generated code as *model\_DWork*, a global data structure.

If you want to interface a block state to your hand-written code, you can specify that the state is to be stored in a location other than the DWork vector. You do this by assigning a storage class to the block state.

You can also define a symbolic name, to be used in code generation, for a block state.

## State Storage Classes

The storage class property of a block state specifies how the Simulink Coder product declares and stores the state in a variable. Storage class options for block states are similar to those for signals. The available storage classes are

- Auto
- ExportedGlobal
- ImportedExtern
- ImportedExternPointer

## Default Storage Class

Auto is the default storage class and is the storage class you should use for states that you do not need to interface to external code. States with Auto storage class are stored as members of the Dwork vector.

You can assign a symbolic name to states with Auto storage class. If you do not supply a name, the Simulink Coder product generates one, as described in “Symbolic Names for States” on page 7-87.

## Explicitly Assigned Storage Classes

Block states with storage classes other than Auto are stored in unstructured global variables, independent of the Dwork vector. These storage classes are for states that you want to interface to external code. The following storage classes are available for states:

- **ExportedGlobal:** The state is stored in a global variable. *model.h* exports the variable. States with **ExportedGlobal** storage class must have unique names.
- **ImportedExtern:** *model\_private.h* declares the state as an extern variable. Your code must supply the variable definition. States with **ImportedExtern** storage class must have unique names.
- **ImportedExternPointer:** *model\_private.h* declares the state as an extern pointer. Your code must supply the pointer variable definition. States with **ImportedExternPointer** storage class must have unique names.

The table in “Summary of Signal Storage Class Options” on page 7-63 gives examples of variable declarations and the code generated for block states with each type of storage class.

---

**Note** Assign a symbolic name to states to specify a storage class other than auto. If you do not supply a name for auto states, the Simulink Coder product generates one, as described in “Symbolic Names for States” on page 7-87.

---

The next section explains how to use the **State Attributes** tab of the block dialog box to assign storage classes to block states.

## Interface States to External Code

In the **State Attributes** tab of a block parameter dialog box, you can interface a block’s state to external code by assigning the state a storage class other than Auto (that is, **ExportedGlobal**, **ImportedExtern**, or **ImportedExternPointer**).

Set the storage class as follows:

- 1 In your block diagram, double-click the desired block. This action opens the block dialog box with two or more tabs, which includes **State Attributes**.
- 2 Click the **State Attributes** tab.

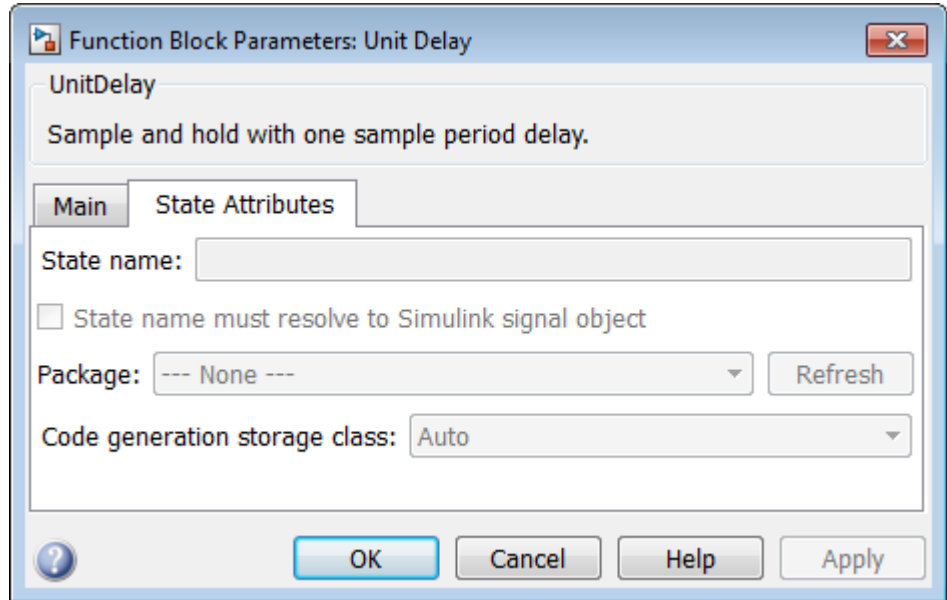

- 3 Enter a name for the variable to be used to store block state in the **State name** field.

The **State name** field turns yellow to indicate that you changed it.

- 4 Click **Apply** to register the variable name.

The first two fields beneath the **State name**, **State name must resolve to Simulink signal object** and **Code generation storage class**, become enabled.

- 5 If the state is to be stored in a Simulink signal object in the base or model workspace, select **State name must resolve to Simulink signal object**.

If you choose this option, you cannot declare a storage class for the state in the block, and the fields below become disabled.

- 6 Select the desired storage class (ExportedGlobal, ImportedExtern, or ImportedExternPointer) from the **Code generation storage class** menu.
- 7 *Optional:* For storage classes other than Auto, you can enter a storage type qualifier such as `const` or `volatile` in the **Code generation storage type qualifier** field. The Simulink Coder product does not check this string for errors; what you enter is included in the variable declaration.
- 8 Click **OK** or **Apply** and close the dialog box.

## Symbolic Names for States

To determine the variable or field name generated for a block's state, you can:

- Use a default name generated by the Simulink Coder product
- Define a symbolic name by using the **State name** field of the **State Attributes** tab in a block dialog box

## Default Block State Naming Convention

If you do not define a symbolic name for a block state, the Simulink Coder product uses the following default naming convention:

BlockType#\_DSTATE

where

- BlockType is the name of the block type (for example, `Discrete_Filter`).
- # is a unique ID number (#) assigned by the Simulink Coder product if multiple instances of the same block type appear in the model. The ID number is appended to BlockType.
- \_DSTATE is a string that is always appended to the block type and ID number.

For example, consider the model shown in the next figure.

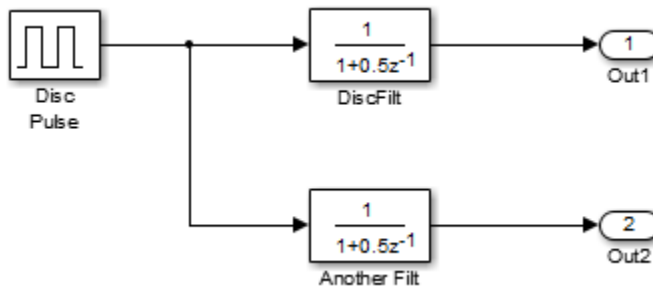

### Model with Two Discrete Filter Block States

Examine the code generated for the states of the two Discrete Filter blocks. Assume that:

- Neither block's state has a user-defined name.
- The upper Discrete Filter block has `Auto` storage class (and is therefore stored in the `DWork` vector).
- The lower Discrete Filter block has `ExportedGlobal` storage class.

The states of the two Discrete Filter blocks are stored in `DWork` vectors, initialized as shown in the code below:

```

/* data type work */
disc_filt_states_M->Work.dwork = ((void *)
&disc_filt_states_DWork);
(void)memset((char_T *) &disc_filt_states_DWork, 0,
sizeof(D_Work_disc_filt_states));
{
    int_T i;
    real_T *dwork_ptr = (real_T *)
&disc_filt_states_DWork.DiscFilt_DSTATE;

    for (i = 0; i < 2; i++) {
        dwork_ptr[i] = 0.0;
    }
}

```



## Define User Block State Names

Using the **State Attributes** tab of a block dialog box, you can define your own symbolic name for a block state:

- 1 In your block diagram, double-click the desired block. This action opens the block dialog box, containing two or more tabs, which includes **State Attributes**.
- 2 Click the **State Attributes** tab.
- 3 Enter the symbolic name in the **State name** field. For example, enter the state name `Top_filter`.
- 4 Click **Apply**. The dialog box now looks like this:

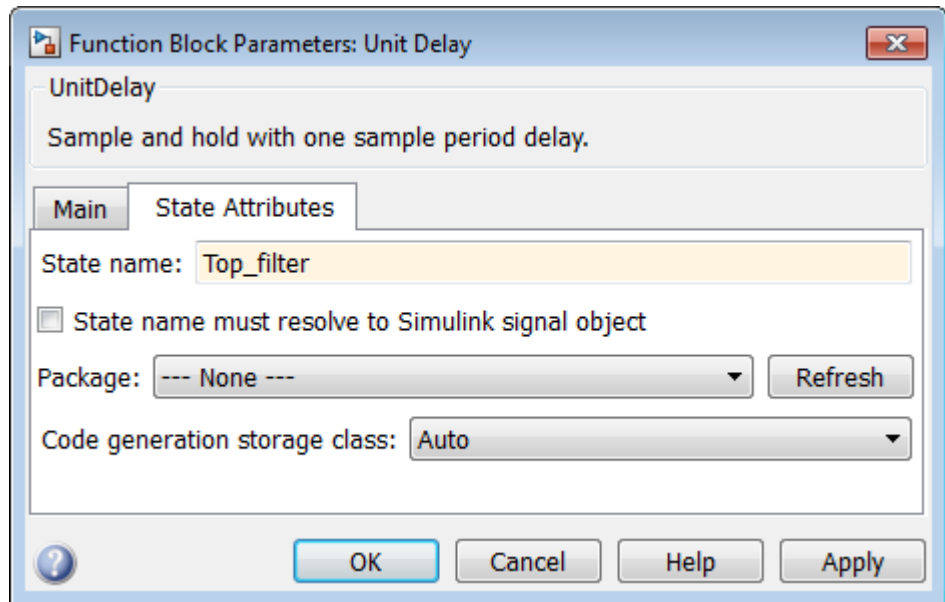

- 5 Click **OK**.

The following state initialization code was generated from the example model shown in “Generate Code for Signal Objects from Command Line” on page 7-67, under the following conditions:

- The upper Discrete Filter block has the state name `Top_filter`, and Auto storage class (and is therefore stored in the `DWork` vector).
- The lower Discrete Filter block has the state name `Lower_filter`, and storage class `ExportedGlobal`.

`Top_filter` is placed in the `Dwork` vector.

```
/* data type work */
    disc_filt_states_M->Work.dwork = ((void *)
&disc_filt_states_DWork);
    (void)memset((char_T *) &disc_filt_states_DWork, 0,
    sizeof(D_Work_disc_filt_states));
    disc_filt_states_DWork.Top_filter = 0.0;

    /* exported global states */
    Lower_filter = 0.0;
```

## Control Code Generation for Block States

If you are not familiar with Simulink data objects and signal objects, you should read “Signals” on page 7-52 before reading this section.

You can associate a block state with a signal object and control code generation for the block state through the signal object:

- 1** Instantiate the desired signal object, and set its `CoderInfo.StorageClass` property.
- 2** Open the dialog box for the block whose state you want to associate with the signal object.
- 3** Click the **State Attributes** tab.
- 4** Enter the name of the signal object in the **State name** field.
- 5** Select **State name must resolve to Simulink signal object**.

This step disables the **Code generation storage class** and **Code generation storage type qualifier** options in the **State Attributes** tab, because the signal object specifies these settings.

6 Click **Apply** and close the dialog box.

---

**Note** When a block state is associated with a signal object, the mapping between the block state and the signal object must be one-to-one. If two or more identically named entities, such as a block state and a signal, map to the same signal object, the name conflict is flagged as an error at code generation time.

---

## Summary of State Storage Class Options

Here is a simple model, `unit_delay`, which contains a Unit Delay block:

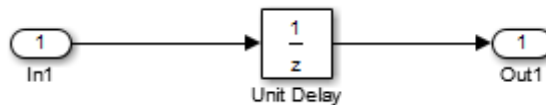

The following table shows, for each state storage class option, the variable declaration and initialization code generated for a Unit Delay block state. The block state has the user-defined state name `udx`.

Storage Class	Declaration	Initialization Code
Auto	In <i>model.h</i>  <pre>typedef struct D_Work_unit_delay_tag {     real_T udx; } D_Work_unit_delay;</pre>	<code>unit_delay_DWork.udx = 0.0;</code>
Exported Global	In <i>model.c</i> or <i>model.cpp</i>  <pre>real_T udx;</pre> In <i>model.h</i>  <pre>extern real_T udx;</pre>	In <i>model.c</i> or <i>model.cpp</i>  <pre>udx = 0.0;</pre>

<b>Storage Class</b>	<b>Declaration</b>	<b>Initialization Code</b>
ImportedExtern	In <i>model_private.h</i>  extern real_T udx;	In <i>model.c</i> or <i>model.cpp</i>  udx = unit_delay_P.UnitDelay_X0;
ImportedExternPointer	In <i>model_private.h</i>  extern real_T *udx;	In <i>model.c</i> or <i>model.cpp</i>  (*udx) = unit_delay_P.UnitDelay_X0;

## Data Stores

### In this section...

“About Data Stores” on page 7-93

“Storage Classes for Data Store Memory Blocks” on page 7-93

“Generate Code for Data Store Memory Blocks” on page 7-96

“Nonscalar Data Stores in Generated Code” on page 7-97

“Data Store Buffering in Generated Code” on page 7-99

### About Data Stores

A data store contains data that is accessible at any point in a model hierarchy at or below the level in which the data store is defined. Data stores can allow subsystems and referenced models to share data without having to use I/O ports to pass the data from level to level. See “Data Stores with Data Store Memory Blocks” for information about data stores in Simulink. This section provides additional information about data store code generation.

### Storage Classes for Data Store Memory Blocks

You can control how Data Store Memory blocks in your model are stored and represented in the generated code by assigning storage classes and type qualifiers. You do this in almost exactly the same way you assign storage classes and type qualifiers for block states.

Data Store Memory blocks, like block states, have `Auto` storage class by default, and their memory is stored within the `DWork` vector. The symbolic name of the storage location is based on the data store name.

You can generate code from multiple Data Store Memory blocks that have the same data store name, subject to the following restriction: *at most one* of the identically named blocks can have a storage class other than `Auto`. An error is reported if this condition is not met.

For blocks with `Auto` storage class, the Simulink Coder product generates a unique symbolic name for each block to avoid name clashes. For Data Store

Memory blocks with storage classes other than Auto, the generated code uses the data store name as the symbol.

In the following model, a Data Store Write block writes to memory declared by the Data Store Memory block myData:



To control the storage declaration for a Data Store Memory block, use the **Code Generation > Storage class** and **Code Generation > Storage type qualifier** fields of the Data Store Memory block dialog box. The next figure shows the Data Store Memory block dialog box for the preceding model.

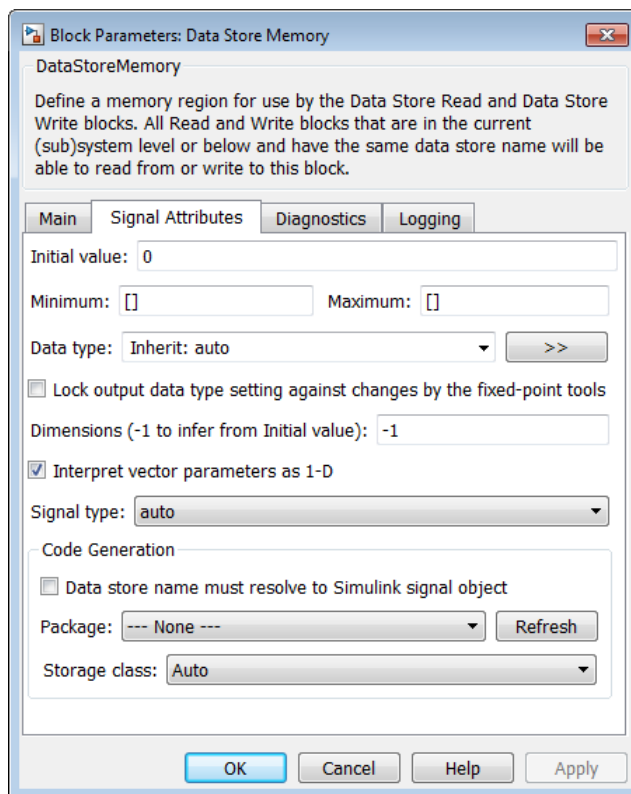

Data Store Memory blocks are nonvirtual because code is generated for their initialization in `.c` and `.cpp` files and their declarations in header files. The following table shows how the code generated for the Data Store Memory block in the preceding model differs for different settings of **Code Generation > Storage class**. The table gives the variable declarations and `MdlOutputs` code generated for the `myData` block.

Storage Class	Declaration	Code
Auto	<p>In <i>model.h</i></p> <pre>typedef struct D_Work_tag {     real_T myData; } D_Work;</pre> <p>In <i>model.c</i> or <i>model.cpp</i></p> <pre>/* Block states (auto storage) */ D_Work model_DWork;</pre>	<pre>model_DWork.myData =     rtb_SineWave;</pre>
ExportedGlobal	<p>In <i>model.c</i> or <i>model.cpp</i></p> <pre>/* Exported block states */ real_T myData;</pre> <p>In <i>model.h</i></p> <pre>extern real_T myData;</pre>	<pre>myData = rtb_SineWave;</pre>
ImportedExtern	<p>In <i>model_private.h</i></p> <pre>extern real_T myData;</pre>	<pre>myData = rtb_SineWave;</pre>
ImportedExternPointer	<p>In <i>model_private.h</i></p> <pre>extern real_T *myData;</pre>	<pre>(*myData) = rtb_SineWave;</pre>

## Generate Code for Data Store Memory Blocks

If you are not familiar with Simulink data objects and signal objects, you should read “Signals” on page 7-52 before reading this section.



You can associate a Data Store Memory block with a signal object, and control code generation for the block through the signal object. To do this:

- 1** Instantiate the desired signal object.
- 2** Set the object's `CoderInfo.StorageClass` property to indicate the desired storage class.
- 3** Open the block dialog box for the Data Store Memory block that you want to associate with the signal object.
- 4** Enter the name of the signal object in the **Data store name** field.
- 5** Select **Data store name must resolve to Simulink signal object**.
- 6** *Do not* set the storage class field to a value other than Auto (the default).
- 7** Click **OK** or **Apply**.

---

**Note** When a Data Store Memory block is associated with a signal object, the mapping between the **Data store name** and the signal object name must be one-to-one. If two or more identically named entities map to the same signal object, the name conflict is flagged as an error at code generation time. See “Resolve Conflicts in Configuration of Signals Objects” on page 7-72 for more information.

---

## Nonscalar Data Stores in Generated Code

Stateflow generates efficient code for accessing individual elements of nonscalar data stores. For example, the next figure shows a data store named A that has seven elements. The Stateflow chart assigns the fourth element of the data store from a value computed from the third element. The generated code is efficient and involves no unnecessary access of any of the other elements of A.

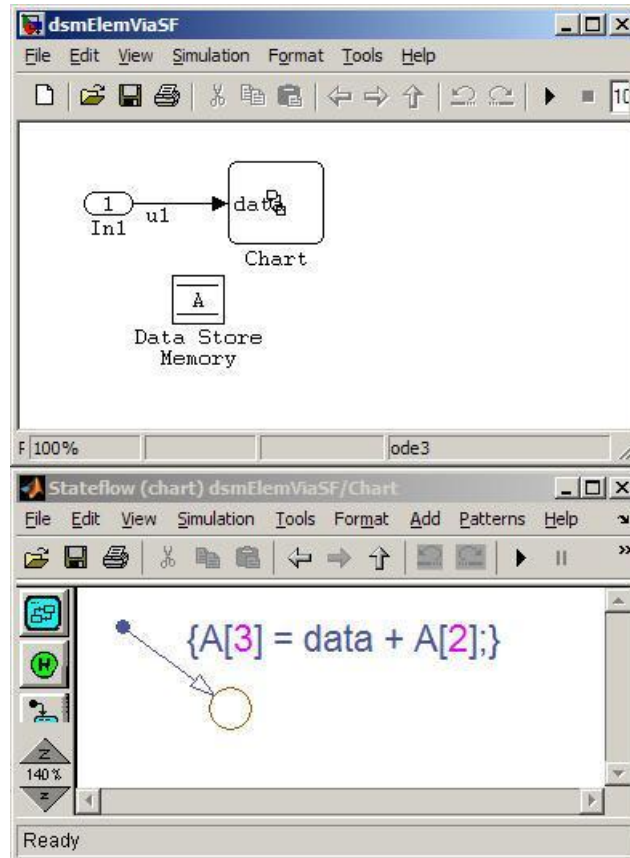

```

/* Model step function */
void dsmElemViaSF_step(void)
{
    /* Stateflow: '<Root>/Chart' incorporates:
     *   Inport: '<Root>/In1'
     */
    A[3] = u1 + A[2];
}

```

In contrast, modeling and code generation for data store element selection and assignment in Simulink is more explicit. The next figure shows the same algorithm modeled without using a Stateflow chart. The assignment block

copies each element of the data store back to itself, in addition to updating the element.

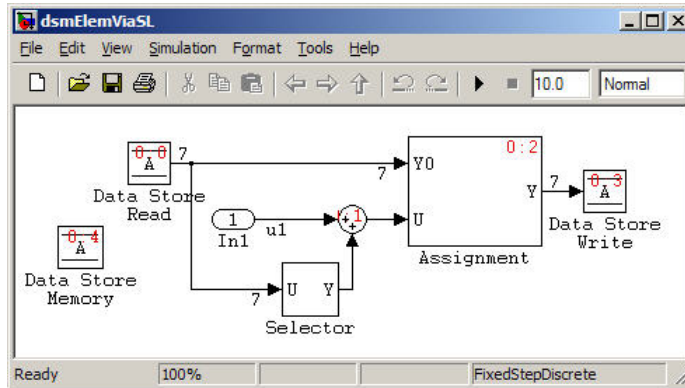

## Data Store Buffering in Generated Code

A Data Store Read block is a nonvirtual block that copies the value of the data store to its output buffer when it executes. Since the value is buffered, all downstream blocks connected to the output of the data store read utilize the same value, even if a Data Store Write block updates the data store in between execution of two of the downstream blocks.

The next figure shows a model that uses blocks whose priorities have been modified to achieve a particular order of execution:

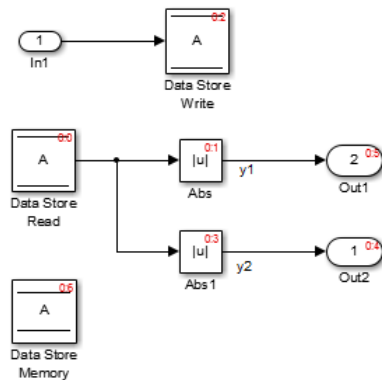

```

/* local block i/o variables */
real_T rtb_DataStoreRead;

/* DataStoreRead: '<Root>/Data Store Read' */
rtb_DataStoreRead = A; Buffer the value of A

/* Abs: '<Root>/Abs1' incorporates:
 * DataStoreRead: '<Root>/Data Store Read'
 */
y1 = fabs(A); Use A (whose value equals
the buffered value at this point

/* DataStoreWrite: '<Root>/Data Store Write' incorporates:
 * Inport: '<Root>/In1'
 */
A = u1; Update the value of A

/* Abs: '<Root>/Abs' */
y2 = fabs(rtb_DataStoreRead); Consistently use the same buffered
value as before the update to A

```

The following execution order applies:

- 1** The block Data Store Read buffers the current value of the data store A at its output.
- 2** The block Abs1 uses the buffered output of Data Store Read.
- 3** The block Data Store Write updates the data store.
- 4** The block Abs uses the buffered output of Data Store Read.

Because the output of Data Store Read is a buffer, both Abs and Abs1 use the same value: the value of the data store at the time that Data Store Read executes.

The next figure shows another example:

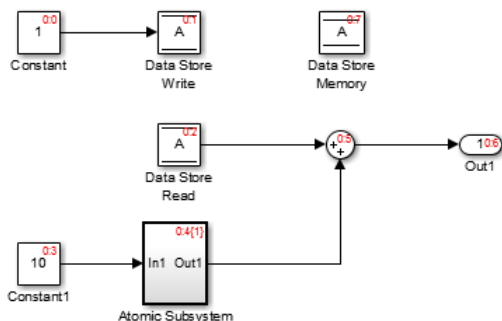

```

real_T rtb_DataStoreRead;

/* DataStoreWrite: '<Root>/Data Store Write' incorporates:
 * Constant: '<Root>/Constant'
 */
A = DoBufferDSMRead2_P.Constant_Value;

/* DataStoreRead: '<Root>/Data Store Read' */
rtb_DataStoreRead = A; Buffer the value of A

/* Outputs for atomic Subsystem: '<Root>/Atomic Subsystem' */
DoBufferDSMRead_AtomicSubsystem(); We don't do a global analysis to
detect if this function writes to A
/* end of Outputs for SubSystem: '<Root>/Atomic Subsystem' */

/* Outputport: '<Root>/Out1' incorporates:
 * Sum: '<Root>/Sum'
 */
DoBufferDSMRead2_Y.Out1 = rtb_DataStoreRead + DoBufferDSMRead2_B.Abs;
Use the buffered value of A

```

In this example, the following execution order applies:

- 1 The block Data Store Read buffers the current value of the data store A at its output.
- 2 Atomic Subsystem executes.
- 3 The Sum block adds the output of Atomic Subsystem to the output of Data Store Read.

Simulink assumes that Atomic Subsystem might update the data store, so Simulink buffers the data store. Atomic Subsystem executes after Data Store

Read buffers its output, and the buffer provides a way for the Sum block to use the value of the data store as it was when Data Store Read executed.

In some cases, the Simulink Coder code generator determines that it can optimize away the output buffer for a Data Store Read block, and the generated code will refer to the data store directly, rather than a buffered value of it. The next figure shows an example:

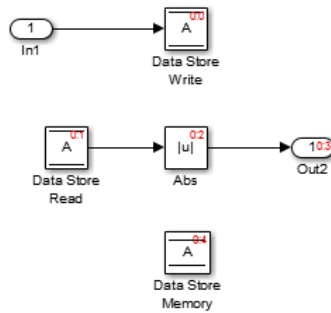

```

/* Model step function */
void DONTbufferDSMRead_step(void)
{
    /* DataStoreWrite: '<Root>/Data Store Write' incorporates:
     * Import: '<Root>/In1'
     */
    A = u1;

    /* Abs: '<Root>/Abs' incorporates:
     * DataStoreRead: '<Root>/Data Store Read'
     */
    y2 = fabs(A);
}

```

In the generated code, the argument of the `fabs()` function is the data store `A` rather than a buffered value.

# Entry Point Functions and Scheduling

---

- “Entry Point Functions and Scheduling” on page 8-2
- “About Model Execution” on page 8-4
- “Non-Real-Time Single-Tasking Systems” on page 8-6
- “Non-Real-Time Multitasking Systems” on page 8-7
- “Real-Time Single-Tasking Systems” on page 8-9
- “Real-Time Multitasking Systems” on page 8-11
- “Multitasking Systems Using Real-Time Tasking Primitives” on page 8-14
- “Program Timing” on page 8-16
- “Program Execution” on page 8-18
- “External Mode Communication” on page 8-19
- “Data Logging in Single-Tasking and Multitasking Model Execution” on page 8-20
- “Rapid Prototyping and Embedded Model Execution Differences” on page 8-22
- “Rapid Prototyping Model Functions” on page 8-23
- “Embedded Model Functions” on page 8-30

## Entry Point Functions and Scheduling

The following functions represent entry points in the generated code for a Simulink model.

Function	Description
<code>model_initialize</code>	Initialization entry point in generated code for Simulink model
<code>model_SetEventsForThisBaseStep</code>	Set event flags for multirate, multitasking operation before calling <code>model_step</code> for Simulink model — not generated as of Version 5.1 (R2008a)
<code>model_step</code>	Step routine entry point in generated code for Simulink model
<code>model_terminate</code>	Termination entry point in generated code for Simulink model

For ERT-based models, the calling interface generated for each of these functions differs significantly depending on how you set the **Generate reusable code** parameter. By default, **Generate reusable code** is off, and the model entry point functions access model data with statically allocated global data structures. When **Generate reusable code** is on, model data structures are passed in (by reference) as arguments to the model entry point functions. For efficiency, only those data structures that are actually used in the model are passed in. Therefore when **Generate reusable code** is on, the argument lists generated for the entry point functions vary according to the requirements of the model.

The entry points are exported with `model.h`. To call the entry-point functions from your hand-written code, add an `#include model.h` directive to your code. For ERT-based models, if **Generate reusable code** is on, you must examine the generated code to determine the calling interface required for these functions.



For more information, see the reference pages for the listed functions.

---

**Note** The function reference pages document the default (GRT or ERT with **Generate reusable code** off) calling interface generated for these functions.

---

## About Model Execution

Before looking at the two styles of generated code, you need to have a high-level understanding of how the generated model code is executed. The Simulink Coder software generates algorithmic code as defined by your model. You can include your own code in your model by using S-functions. S-functions can range from high-level signal manipulation algorithms to low-level device drivers.

The Simulink Coder product also provides a run-time interface that executes the generated model code. The run-time interface and model code are compiled together to create the model executable. The next figure shows a high-level object-oriented view of the executable.

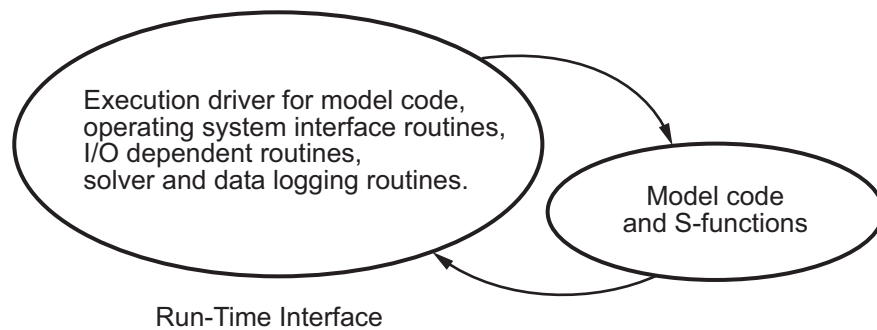

### The Object-Oriented View of a Real-Time Program

In general, the conceptual design of the model execution driver does not change between the rapid prototyping and embedded style of generated code. The following sections describe model execution for single-tasking and multitasking environments both for simulation (non-real-time) and for real time. For most models, the multitasking environment will provide the most efficient model execution (that is, fastest sample rate).

The following concepts are useful in describing how models execute.

- **Initialization:** `model_initialize` initializes the run-time interface code and the model code.
- **ModelOutputs:** Calling all blocks in your model that have a sample hit at the current time and having them produce their output. `model_output` can

be done in major or minor time steps. In major time steps, the output is a given simulation time step. In minor time steps, the run-time interface integrates the derivatives to update the continuous states.

- **ModelUpdate:** *model\_update* calls all blocks in your model that have a sample hit at the current point in time and has them update their discrete states or similar type objects.
- **ModelDerivatives:** Calling all blocks in your model that have continuous states and having them update their derivatives. *model\_derivatives* is only called in minor time steps.
- **ModelTerminate:** *model\_terminate* terminates the program if it is designed to run for a finite time. It destroys the real-time model data structure, deallocates memory, and can write data to a file.

The identifying names in the preceding list (*ModelOutputs*, and so on) identify functions in pseudocode examples shown in the following sections.

- “Non-Real-Time Single-Tasking Systems” on page 8-6
- “Non-Real-Time Multitasking Systems” on page 8-7
- “Real-Time Single-Tasking Systems” on page 8-9
- “Real-Time Multitasking Systems” on page 8-11
- “Multitasking Systems Using Real-Time Tasking Primitives” on page 8-14

## Non-Real-Time Single-Tasking Systems

The pseudocode below shows the execution of a model for a non-real-time single-tasking system.

```
main()
{
  Initialization
  While (time < final time)
    ModelOutputs      -- Major time step.
    LogTXY            -- Log time, states and root outputs.
    ModelUpdate       -- Major time step.
    Integrate         -- Integration in minor time step for
                      -- models with continuous states.
    ModelDerivatives
    Do 0 or more
      ModelOutputs
      ModelDerivatives
    EndDo -- Number of iterations depends upon the solver
    Integrate derivatives to update continuous states.
  EndIntegrate
EndWhile
Termination
}
```

The initialization phase begins first. This consists of initializing model states and setting up the execution engine. The model then executes, one step at a time. First `ModelOutputs` executes at time  $t$ , then the workspace I/O data is logged, and then `ModelUpdate` updates the discrete states. Next, if your model has any continuous states, `ModelDerivatives` integrates the continuous states' derivatives to generate the states for time  $t_{new} = t + h$ , where  $h$  is the step size. Time then moves forward to  $t_{new}$  and the process repeats.

During the `ModelOutputs` and `ModelUpdate` phases of model execution, only blocks that reach the current point in time execute.

## Non-Real-Time Multitasking Systems

The pseudocode below shows the execution of a model for a non-real-time multitasking system.

```

main()
{
  Initialization
  While (time < final time)
    ModelOutputs(tid=0)  -- Major time step.
    LogTXY               -- Log time, states, and root
                        -- outports.
    ModelUpdate(tid=0)  -- Major time step.
    Integrate           -- Integration in minor time step for
                        -- models with continuous states.
    ModelDerivatives
    Do 0 or more
      ModelOutputs(tid=0)
      ModelDerivatives
    EndDo (Number of iterations depends upon the solver.)
    Integrate derivatives to update continuous states.
  EndIntegrate
  For i=1:NumTids
    ModelOutputs(tid=i) -- Major time step.
    ModelUpdate(tid=i) -- Major time step.
  EndFor
EndWhile
Termination
}

```

Multitasking operation is more complex than single-tasking execution because the output and update functions are subdivided by the *task identifier* (*tid*) that is passed into these functions. This allows for multiple invocations of these functions with different task identifiers using overlapped interrupts, or for multiple tasks when using a real-time operating system. In simulation, multiple tasks are emulated by executing the code in the order that would occur if no preemption existed in a real-time system.

Multitasking execution assumes that all task rates are multiples of the base rate. The Simulink product enforces this when you create a fixed-step

multitasking model. The multitasking execution loop is very similar to that of single-tasking, except for the use of the task identifier (tid) argument to `ModelOutputs` and `ModelUpdate`.

## Real-Time Single-Tasking Systems

The pseudocode below shows the execution of a model in a real-time single-tasking system where the model is run at interrupt level.

```
rtOneStep()
{
    Check for interrupt overflow
    Enable "rtOneStep" interrupt
    ModelOutputs    -- Major time step.
    LogTXY          -- Log time, states and root outputs.
    ModelUpdate     -- Major time step.
    Integrate       -- Integration in minor time step for models
                   -- with continuous states.
        ModelDerivatives
        Do 0 or more
            ModelOutputs
            ModelDerivatives
        EndDo (Number of iterations depends upon the solver.)
        Integrate derivatives to update continuous states.
    EndIntegrate
}

main()
{
    Initialization (including installation of rtOneStep as an
    interrupt service routine, ISR, for a real-time clock).
    While(time < final time)
        Background task.
    EndWhile
    Mask interrupts (Disable rtOneStep from executing.)
    Complete any background tasks.
    Shutdown
}
```

Real-time single-tasking execution is very similar to non-real-time single-tasking execution, except that instead of free-running the code, the `rt_OneStep` function is driven by a periodic timer interrupt.

At the interval specified by the program's base sample rate, the interrupt service routine (ISR) preempts the background task to execute the model code. The base sample rate is the fastest in the model. If the model has continuous blocks, then the integration step size determines the base sample rate.

For example, if the model code is a controller operating at 100 Hz, then every 0.01 seconds the background task is interrupted. During this interrupt, the controller reads its inputs from the analog-to-digital converter (ADC), calculates its outputs, writes these outputs to the digital-to-analog converter (DAC), and updates its states. Program control then returns to the background task. All these steps must occur before the next interrupt.



## Real-Time Multitasking Systems

The following pseudocode shows how a model executes in a real-time multitasking system where the model is run at interrupt level.

```

rtOneStep()
{
    Check for interrupt overflow
    Enable "rtOneStep" interrupt
    ModelOutputs(tid=0)    -- Major time step.
    LogTXY                 -- Log time, states and root outputs.
    ModelUpdate(tid=0)     -- Major time step.
    Integrate              -- Integration in minor time step for
                          -- models with continuous states.

        ModelDerivatives
        Do 0 or more
            ModelOutputs(tid=0)
            ModelDerivatives
        EndDo (Number of iterations depends upon the solver.)
        Integrate derivatives and update continuous states.
    EndIntegrate
    For i=1:NumTasks
        If (hit in task i)
            ModelOutputs(tid=i)
            ModelUpdate(tid=i)
        EndIf
    EndFor
}

main()
{
    Initialization (including installation of rtOneStep as an
                    interrupt service routine, ISR, for a real-time clock).
    While(time < final time)
        Background task.
    EndWhile
    Mask interrupts (Disable rtOneStep from executing.)
    Complete any background tasks.
    Shutdown
}

```

Running models at interrupt level in a real-time multitasking environment is very similar to the previous single-tasking environment, except that overlapped interrupts are employed for concurrent execution of the tasks.

The execution of a model in a single-tasking or multitasking environment when using real-time operating system tasking primitives is very similar to the interrupt-level examples discussed above. The pseudocode below is for a single-tasking model using real-time tasking primitives.

```
tSingleRate()
{
  MainLoop:
    If clockSem already "given", then error out due to overflow.
    Wait on clockSem
    ModelOutputs           -- Major time step.
    LogTXY                 -- Log time, states and root
                          -- outputs
    ModelUpdate           -- Major time step
    Integrate             -- Integration in minor time step
                          -- for models with continuous
                          -- states.

    ModelDerivatives
    Do 0 or more
      ModelOutputs
      ModelDerivatives
    EndDo (Number of iterations depends upon the solver.)
    Integrate derivatives to update continuous states.
  EndIntegrate
EndMainLoop
}

main()
{
  Initialization
  Start/spawn task "tSingleRate".
  Start clock that does a "semGive" on a clockSem semaphore.
  Wait on "model-running" semaphore.
  Shutdown
}
```

In this single-tasking environment, the model executes as real-time operating system tasking primitives. In this environment, create a single task (`tSingleRate`) to run the model code. This task is invoked when a clock tick occurs. The clock tick gives a `clockSem` (clock semaphore) to the model task (`tSingleRate`). The model task waits for the semaphore before executing. The clock ticks occur at the fundamental step size (base rate) for your model.

## Multitasking Systems Using Real-Time Tasking Primitives

The pseudocode below is for a multitasking model using real-time tasking primitives.

```

tSubRate(subTaskSem,i)
{
  Loop:
    Wait on semaphore subTaskSem.
    ModelOutputs(tid=i)
    ModelUpdate(tid=i)
  EndLoop
}
tBaseRate()
{
  MainLoop:
    If clockSem already "given", then error out due to overflow.
    Wait on clockSem
    For i=1:NumTasks
      If (hit in task i)
        If task i is currently executing, then error out due to
        overflow.
        Do a "semGive" on subTaskSem for task i.
      EndIf
    EndFor
    ModelOutputs(tid=0)      -- major time step.
    LogTXY                  -- Log time, states and root outports.
    ModelUpdate(tid=0)      -- major time step.
    Loop:                   -- Integration in minor time step for
                          -- models with continuous states.
      ModelDerivatives
      Do 0 or more
        ModelOutputs(tid=0)
        ModelDerivatives
      EndDo (number of iterations depends upon the solver).
      Integrate derivatives to update continuous states.
    EndLoop
  EndMainLoop
}
main()

```

```
{
  Initialization
  Start/spawn task "tSubRate".
  Start/spawn task "tBaseRate".

  Start clock that does a "semGive" on a clockSem semaphore.
  Wait on "model-running" semaphore.
  Shutdown
}
```

In this multitasking environment, the model is executed using real-time operating system tasking primitives. Such environments require several model tasks (`tBaseRate` and several `tSubRate` tasks) to run the model code. The base rate task (`tBaseRate`) has a higher priority than the subrate tasks. The subrate task for `tid=1` has a higher priority than the subrate task for `tid=2`, and so on. The base rate task is invoked when a clock tick occurs. The clock tick gives a `clockSem` to `tBaseRate`. The first thing `tBaseRate` does is give semaphores to the subtasks that have a hit at the current point in time. Because the base rate task has a higher priority, it continues to execute. Next it executes the fastest task (`tid=0`), consisting of blocks in your model that have the fastest sample time. After this execution, it resumes waiting for the clock semaphore. The clock ticks are configured to occur at the fundamental step size for your model.

## Program Timing

Real-time programs require careful timing of the task invocations (either by using an interrupt or a real-time operating system tasking primitive) so that the model code executes to completion before another task invocation occurs. This includes time to read and write data to and from external hardware.

The next figure illustrates interrupt timing.

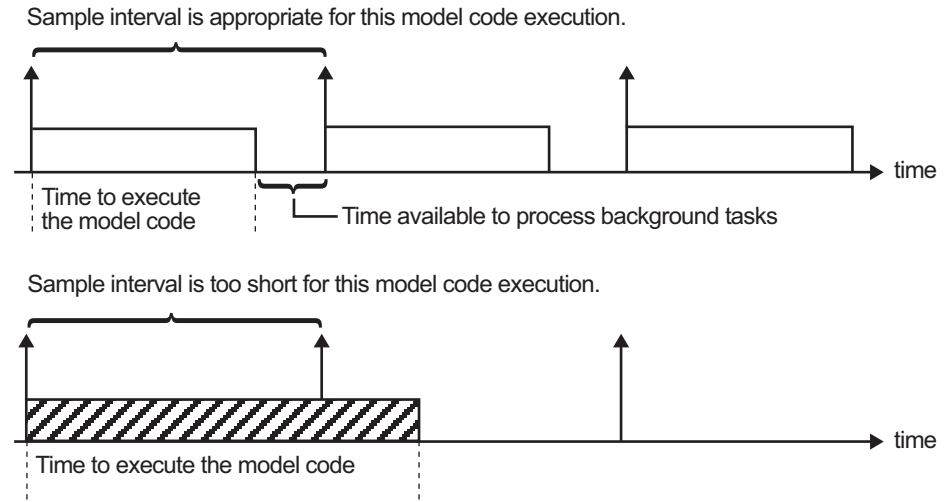

### Task Timing

The sample interval must be long enough to allow model code execution between task invocations.

In the figure above, the time between two adjacent vertical arrows is the sample interval. The empty boxes in the upper diagram show an example of a program that can complete one step within the interval and still allow time for the background task. The gray box in the lower diagram indicates what happens if the sample interval is too short. Another task invocation occurs before the task is complete. Such timing results in an execution error.

Note also that, if the real-time program is designed to run forever (that is, the final time is 0 or infinite so the while loop never exits), then the shutdown code never executes.

For more information on how the timing engine works, see “Timers” on page 1-79.

### Program Execution

As the previous section indicates, a real-time program cannot require 100% of the CPU's time. This provides an opportunity to run background tasks during the free time.

Background tasks include operations such as writing data to a buffer or file, allowing access to program data by third-party data monitoring tools, or using Simulink external mode to update program parameters.

It is important, however, that the program be able to preempt the background task so the model code can execute in real time.

The way the program manages tasks depends on capabilities of the environment in which it operates.



## External Mode Communication

External mode allows communication between the Simulink block diagram and the standalone program that is built from the generated code. In this mode, the real-time program functions as an interprocess communication server, responding to requests from the Simulink engine.

## Data Logging in Single-Tasking and Multitasking Model Execution

The Simulink Coder data-logging features, described in “Debug” on page 9-80, enable you to save system states, outputs, and time to a MAT-file at the completion of the model execution. The LogTXY function, which performs data logging, operates differently in single-tasking and multitasking environments.

If you examine how LogTXY is called in the single-tasking and multitasking environments, you will notice that for single-tasking LogTXY is called after ModelOutputs. During this ModelOutputs call, all blocks that have a hit at time  $t$  execute, whereas in multitasking, LogTXY is called after ModelOutputs(tid=0), which executes only the blocks that have a hit at time  $t$  and that have a task identifier of 0. This results in differences in the logged values between single-tasking and multitasking logging. Specifically, consider a model with two sample times, the faster sample time having a period of 1.0 second and the slower sample time having a period of 10.0 seconds. At time  $t = k*10$ ,  $k=0,1,2\dots$  both the fast (tid=0) and slow (tid=1) blocks execute. When executing in multitasking mode, when LogTXY is called, the slow blocks execute, but the previous value is logged, whereas in single-tasking the current value is logged.

Another difference occurs when logging data in an enabled subsystem. Consider an enabled subsystem that has a slow signal driving the enable port and fast blocks within the enabled subsystem. In this case, the evaluation of the enable signal occurs in a slow task, and the fast blocks see a delay of one sample period; thus the logged values will show these differences.

To summarize differences in logged data between single-tasking and multitasking, differences will be seen when

- Any root output block has a sample time that is slower than the fastest sample time
- Any block with states has a sample time that is slower than the fastest sample time
- Any block in an enabled subsystem where the signal driving the enable port is slower than the rate of the blocks in the enabled subsystem

For the first two cases, even though the logged values are different between single-tasking and multitasking, the model results are not different. The only real difference is where (at what point in time) the logging is done. The third (enabled subsystem) case results in a delay that can be seen in a real-time environment.

## Rapid Prototyping and Embedded Model Execution Differences

The rapid prototyping program framework provides a common application programming interface (API) that does not change between model definitions.

The Embedded Coder product provides a different framework called the embedded program framework. The embedded program framework provides an optimized API that is tailored to your model. When you use the embedded style of generated code, you are modeling how you would like your code to execute in your embedded system. Therefore, the definitions defined in your model should be specific to your embedded targets. Items such as the model name, parameter, and signal storage class are included as part of the API for the embedded style of code.

One major difference between the rapid prototyping and embedded style of generated code is that the latter contains fewer entry-point functions. The embedded style of code can be configured to have only one run-time function, *model\_step*.

Thus, when you look again at the model execution pseudocode presented earlier in this chapter, you can eliminate the `Loop...EndLoop` statements, and group `ModelOutputs`, `LogTXY`, and `ModelUpdate` into a single statement, *model\_step*.

For more information about how generated embedded code executes, see “Embedded Model Functions” on page 8-30.

## Rapid Prototyping Model Functions

The rapid prototyping code defines the following functions that interface with the run-time interface:

- `Model()`: The model registration function. This function initializes the work areas (for example, allocating and setting pointers to various data structures) used by the model. The model registration function calls the `MdlInitializeSizes` and `MdlInitializeSampleTimes` functions. These two functions are very similar to the S-function `mdlInitializeSizes` and `mdlInitializeSampleTimes` methods.
- `MdlStart(void)`: After the model registration functions `MdlInitializeSizes` and `MdlInitializeSampleTimes` execute, the run-time interface starts execution by calling `MdlStart`. This routine is called once at startup.

The function `MdlStart` has four basic sections:

- Code to initialize the states for each block in the root model that has states. A subroutine call is made to the “initialize states” routines of conditionally executed subsystems.
  - Code generated by the one-time initialization (start) function for each block in the model.
  - Code to enable the blocks in the root model that have enable methods, and the blocks inside triggered or function-call subsystems residing in the root model. Simulink blocks can have enable and disable methods. An enable method is called just before a block starts executing, and the disable method is called just after the block stops executing.
  - Code for each block in the model that has a constant sample time.
- `MdlOutputs(int_T tid)`: `MdlOutputs` updates the output of blocks. The `tid` (task identifier) parameter identifies the task that in turn maps when to execute blocks based upon their sample time. This routine is invoked by the run-time interface during major and minor time steps. The major time steps are when the run-time interface is taking an actual time step (that is, it is time to execute a specific task). If your model contains continuous states, the minor time steps will be taken. The minor time steps are when the solver is generating integration stages, which are points between major

outputs. These integration stages are used to compute the derivatives used in advancing the continuous states. The solver is called to updates

- `MdlUpdate(int_T tid)`: `MdlUpdate` updates the states and work vector state information (that is, states that are neither continuous nor discrete) saved in work vectors. The `tid` (task identifier) parameter identifies the task that in turn indicates which sample times are active, allowing you to conditionally update only states of active blocks. This routine is invoked by the run-time interface after the major `MdlOutputs` has been executed. The solver is also called, and `model_Derivatives` is called in minor steps by the solver during its integration stages. All blocks that have continuous states have an identical number of derivatives. These blocks are required to compute the derivatives so that the solvers can integrate the states.
- `MdlTerminate(void)`: `MdlTerminate` contains any block shutdown code. `MdlTerminate` is called by the run-time interface, as part of the termination of the real-time program.

The contents of the above functions are directly related to the blocks in your model. A Simulink block can be generalized to the following set of equations.

$$y = f_0(t, x_c, x_d, u)$$

Output  $y$  is a function of continuous state  $x_c$ , discrete state  $x_d$ , and input  $u$ . Each block writes its specific equation in a section of `MdlOutputs`.

$$x_{d+1} = f_u(t, x_d, u)$$

The discrete states  $x_d$  are a function of the current state and input. Each block that has a discrete state updates its state in `MdlUpdate`.

$$\dot{x} = f_d(t, x_c, u)$$

The derivatives  $x$  are a function of the current input. Each block that has continuous states provides its derivatives to the solver (for example, `ode5`) in `model_Derivatives`. The derivatives are used by the solver to integrate the continuous state to produce the next value.

The output,  $y$ , is generally written to the block I/O structure. Root-level Output blocks write to the external outputs structure. The continuous and

discrete states are stored in the `states` structure. The input,  $u$ , can originate from another block's output, which is located in the block I/O structure, an external input (located in the `external inputs` structure), or a state. These structures are defined in the `model.h` file that the Simulink Coder software generates.

The next example shows the general contents of the rapid prototyping style of C code written to the `model.c` file.

```
/*
 * Version, Model options, TLC options,
 * and code generation information are placed here.
 */
<includes>
void MdlStart(void)
{
    /*
     * State initialization code.
     * Model start-up code - one time initialization code.
     * Execute any block enable methods.
     * Initialize output of any blocks with constant sample times.
     */
}

void MdlOutputs(int_T tid)
{
    /* Compute: y = f0(t,xc,xd,u) for each block as needed. */
}

void MdlUpdate(int_T tid)
{
    /* Compute: xd+1 = fu(t,xd,u) for each block as needed. */

    /* Compute: dxc = fd(t,xc,u) for each block in model_derivatives
       as needed. */
}
void MdlTerminate(void)
{
    /* Perform shutdown code for any blocks that
       have a termination action */
}
}
```

The next figure shows a flow chart describing the execution of the rapid prototyping generated code.



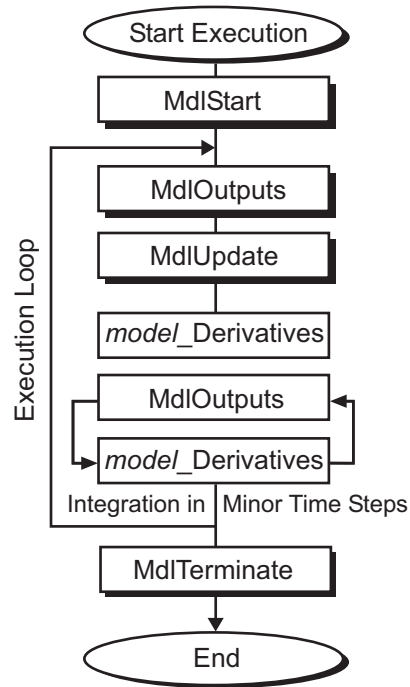

### Rapid Prototyping Execution Flow Chart

Each block places code in specific Mdl routines according to the algorithm that it is implementing. Blocks have input, output, parameters, and states, as well as other general items. For example, in general, block inputs and outputs are written to a block I/O structure (*model\_B*). Block inputs can also come from the external input structure (*model\_U*) or the state structure when connected to a state port of an integrator (*model\_X*), or ground (*rtGround*) if unconnected or grounded. Block outputs can also go to the external output structure (*model\_Y*). The next figure shows the general mapping between these items.

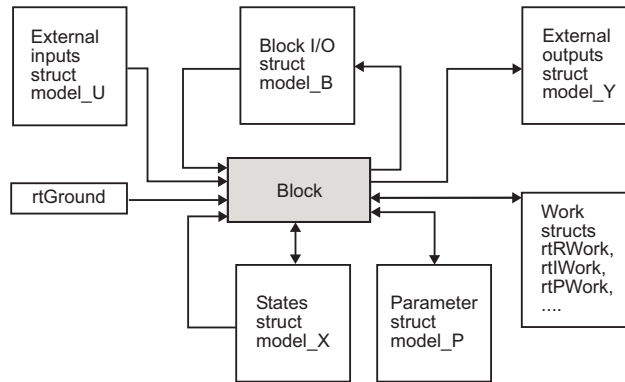

### Data View of the Generated Code

The following list defines the structures shown in the preceding figure:

- Block I/O structure (*model\_B*): This structure consists of persistent block output signals. The number of block output signals is the sum of the widths of the data output ports of all nonvirtual blocks in your model. If you activate block I/O optimizations, the Simulink and Simulink Coder products reduce the size of the *model\_B* structure by
  - Reusing the entries in the *model\_B* structure
  - Making other entries local variables

See “Signals” on page 7-52 for more information on these optimizations.

Structure field names are determined either by the block’s output signal name (when present) or by the block name and port number when the output signal is left unlabeled.

- Block states structures: The continuous states structure (*model\_X*) contains the continuous state information for any blocks in your model that have continuous states. Discrete states are stored in a data structure called the *DWork vector* (*model\_DWork*).
- Block parameters structure (*model\_P*): The parameters structure contains block parameters that can be changed during execution (for example, the parameter of a Gain block).
- External inputs structure (*model\_U*): The external inputs structure consists of all root-level Inport block signals. Field names are determined by either

the block's output signal name, when present, or by the Inport block's name when the output signal is left unlabeled.

- External outputs structure (*model\_Y*): The external outputs structure consists of all root-level Outport blocks. Field names are determined by the root-level Outport block names in your model.
- Real work, integer work, and pointer work structures (*model\_RWork*, *model\_IWork*, *model\_PWork*): Blocks might have a need for real, integer, or pointer work areas. For example, the Memory block uses a real work element for each signal. These areas are used to save internal states or similar information.

# Embedded Model Functions

The Embedded Coder target generates the following functions:

- *model\_initialize*: Performs model initialization and should be called once before you start executing your model.
- If the **Single output/update function** code generation option is selected, then you see
  - *model\_step*: Contains the output and update code for all blocks in your model.

Otherwise, you see

- *model\_output*: Contains the output code for all blocks in your model.
- *model\_update*: Contains the update code for all blocks in your model.
- If the **Terminate function required** code generation option is selected, then you see
  - *model\_terminate*: This contains model shutdown code and should be called as part of system shutdown.

See “Entry Point Functions and Scheduling” in the Embedded Coder documentation for complete descriptions of these functions.

# Code Generation

---

- Chapter 9, “Configuration”
- Chapter 10, “Source Code Generation”
- Chapter 11, “Report Generation”



# Configuration

---

- “Configuring a Model for Code Generation” on page 9-2
- “Application Objectives” on page 9-6
- “Target” on page 9-9
- “Select the Target Language” on page 9-71
- “Code Appearance” on page 9-72
- “Debug” on page 9-80

## Configuring a Model for Code Generation

### In this section...

“Code Generation Configuration” on page 9-2

“Open the Model Configuration for Code Generation” on page 9-3

“Configure a Model Programmatically” on page 9-3

### Code Generation Configuration

When you are ready to generate code for a model, you can modify the model configuration parameters specific to code generation. The code generation parameters affect how the Simulink Coder software generates code and builds an executable from your model.

Your application objectives might include a combination of the following code generation objectives: debugging, traceability, execution efficiency, and safety precaution. There are tradeoffs associated with these configuration choices, such as execution speed and memory usage. You can use the Model Advisor and the Code Generation Advisor to help configure any model to achieve your application objectives. For more information, see “Advice About Optimizing Models for Code Generation” on page 16-5 and “Configure Code Generation Objectives Using Code Generation Advisor” on page 9-7.

You modify the model configuration parameters for code generation in the **Code Generation** and **Optimization** panes of the Configuration Parameters dialog box. The content of the **Code Generation** pane and its subpanes can change depending on the target that you specify. To open the **Code Generation** pane, see “Open the Model Configuration for Code Generation” on page 9-3. Some configuration options are available only with the Embedded Coder product. The **Optimization** pane includes code generation parameters that help to improve the performance of the generated code.

To automate the configuration of models, you can use the `set_param` function from the MATLAB command line to adjust the model configuration parameters. For more information, see “Parameter Command-Line Information Summary” in the Simulink Coder documentation. For an example of automating the configuration of a model, see “Configure a Model Programmatically” on page 9-3.



## Open the Model Configuration for Code Generation

To modify the model configuration parameters for code generation, open the **Code Generation** pane. There are four ways to open the **Code Generation** pane from the Simulink editor:

- To open the Configuration Parameters dialog box, click the model configuration parameters icon:



and select **Code Generation**.

- From the **Simulation** menu, select **Model Configuration Parameters**. When the Configuration Parameters dialog box opens, click **Code Generation** in the **Select** (left) pane.
- From the Code menu, select **C/C++ Code > Code Generation Options**.
- From the **View** menu in the model window, select **Model Explorer**, or from the MATLAB command line, type `daexplr` and press **Enter**. In the Model Explorer, expand the node for the current model in the left pane and click **Configuration (active)**. The configuration elements are listed in the middle pane. Clicking any of these elements displays the corresponding parameters in the right pane. Alternatively, right-clicking the **Code Generation** element in the middle pane and choosing **Properties** from the context menu opens the **Code Generation** pane in a separate window.

---

**Note** In a Configuration Parameters dialog box, when you change a check box, menu selection, or edit field, the white background of the element turns to light yellow to indicate that you made an unsaved change. When you click **OK**, **Cancel**, or **Apply**, the background resets to white.

---

For more information on model configurations, see “Configuration Sets”.

## Configure a Model Programmatically

This example shows you how to modify code generation parameters for the active configuration set from the MATLAB command line. Use this approach for creating a script that automates setting parameters for an established

model configuration. The configuration parameters that you can get and set are listed in “Parameter Command-Line Information Summary” in the Simulink Coder reference.

In this example, you modify the configuration parameters to support the Code Generation Advisor application objective, Execution efficiency.

**Step 1. Open a model.**

```
sldemo_f14
```

**Step 2. Get the active configuration set.**

```
cs = getActiveConfigSet(model);
```

**Step 3. Select the Generic Real-Time (GRT) target.**

```
switchTarget(cs, 'grt.tlc', []);
```

**Step 4. Modify parameters to optimize execution speed.**

If your application objective is Execution efficiency, use `set_param` to modify the following parameters:

```
set_param(cs, 'MatFileLogging', 'off');  
set_param(cs, 'SupportNonFinite', 'off');  
set_param(cs, 'RTWCompilerOptimization', 'on');  
set_param(cs, 'OptimizeBlockIOStorage', 'on');  
set_param(cs, 'EnhancedBackFolding', 'on');  
set_param(cs, 'ConditionallyExecuteInputs', 'on');  
set_param(cs, 'InlineParams', 'on');  
set_param(cs, 'BooleanDataType', 'on');  
set_param(cs, 'BlockReduction', 'on');  
set_param(cs, 'ExpressionFolding', 'on');  
set_param(cs, 'LocalBlockOutputs', 'on');  
set_param(cs, 'EfficientFloat2IntCast', 'on');  
set_param(cs, 'BufferReuse', 'on');
```

**Step 5. Save the model configuration to a file.**

Save the model configuration to a file, 'Exec\_efficiency\_cs.m', and view the parameter settings.

```
saveAs(cs, 'Exec_Efficiency_cs');  
dbtype Exec_Efficiency_cs 1:50
```

Using this technique, you can create a script to configure multiple models. An alternative method for configuring multiple models is to save the configuration set to the base workspace. Then, create a configuration reference to point to that configuration set. For more information, see “About Configuration References”.

## Application Objectives

**In this section...**

“About Code Generation Objectives” on page 9-6

“Configure Code Generation Objectives Using Code Generation Advisor” on page 9-7

### About Code Generation Objectives

Depending on the type of application that your model represents, you are likely to have specific code generation objectives in mind. For example, safety and traceability might be more critical than efficient use of memory. If you have specific objectives in mind, you can quickly configure your model to meet those objectives by selecting and prioritizing from the following list of code generation objectives:

- Execution efficiency (all targets)
- ROM efficiency (ERT-based targets)
- RAM efficiency (ERT-based targets)
- Safety precaution (ERT-based targets)
- Traceability (ERT-based targets)
- Debugging (all targets)
- MISRA-C:2004 guidelines (ERT-based targets)

Based on your objective selections and prioritization, the Code Generation Advisor checks your model and suggests changes that you can make to achieve your code generation objectives.

---

**Note** If you select the MISRA-C:2004 guidelines code generation objective, the Code Generation Advisor checks:

- The model configuration settings for compliance with the MISRA-C:2004 configuration setting recommendations.
  - For blocks that are not supported or recommended for MISRA-C:2004 compliant code generation.
- 

Setting code generation objectives and running the Code Generation Advisor provides information on how to meet code generation objectives for your model. The Code Generation Advisor does not alter the generated code. You can use the Code Generation Advisor to make the suggested changes to your model. The generated code is changed only after you modify your model and regenerate code. If you use the Code Generation Advisor to set code generation objectives and check your model, the generated code includes comments identifying which objectives you specified, the checks the Code Generation Advisor ran on the model, and the results of running the checks.

For detailed information, see “Application Objectives” in the Embedded Coder documentation.

## **Configure Code Generation Objectives Using Code Generation Advisor**

To configure the code generation objectives and use the Code Generation Advisor:

- 1** Open the Configuration Parameters dialog box and select **Code Generation**.
- 2** Select or confirm selection of a System target file.
- 3** Specify the objectives using the **Select objectives** drop down list (GRT-based targets) or clicking **Set objectives** button (ERT-based targets). Clicking **Set objectives** opens the Set Objectives - Code Generation Advisor dialog box.

- 4** Click **Check model** to run the model checks. The Code Generation Advisor dialog box opens. The Code Generation Advisor uses the code generation objectives to determine which model checks to run.
- 5** On the left pane, the Code Generation Advisor lists the checks run on the model and the results. Click each warning to see the suggestions for changes that you can make to your model to pass the check.
- 6** Determine which changes to make to your model. On the right pane of the Code Generation Advisor, follow the instructions listed for each check to modify the model.

To run the Code Generation Advisor during code generation, on the **Code Generation** pane, set the **Check model before generating code** parameter to either:

- On (stop for warnings) - Code generation stops with a check warning. The Code Generation Advisor dialog box opens as described in step 5.
- On (proceed with warnings) - Code generation proceeds with check warnings. The Code Generation Advisor interface opens with a list of the checks it ran on the model, along with the results.

For more information, see “Set Objectives — Code Generation Advisor Dialog Box”

# Target

## In this section...

- “Hardware Targets” on page 9-9
- “Available Targets” on page 9-10
- “About Targets and Code Formats” on page 9-15
- “Types of Target Code Formats” on page 9-16
- “Targets and Code Formats” on page 9-29
- “Targets and Code Styles” on page 9-29
- “Backwards Compatibility of Code Formats” on page 9-31
- “Selecting a Target” on page 9-34
- “Template Makefiles and Make Options” on page 9-38
- “Custom Targets” on page 9-44
- “Describing the Emulation and Embedded Targets” on page 9-45
- “Describing Embedded Hardware Characteristics” on page 9-54
- “Describing Emulation Hardware Characteristics” on page 9-55
- “Specifying Target Interfaces” on page 9-58
- “Selecting and Viewing Code Replacement Libraries” on page 9-61

## Hardware Targets

When you use Simulink software to create and execute a model, and Simulink Coder software to generate code, you may need to consider up to three platforms, often called *hardware targets*:

- MATLAB Host — The platform that runs MathWorks software during application development
- Embedded Target — The platform on which an application will be deployed when it is put into production
- Emulation Target — The platform on which an application under development is tested before deployment

The same platform might serve in two or possibly all three capacities, but they remain conceptually distinct. Often the MATLAB host and the emulation target are the same. The embedded target is usually different from, and less powerful than, the MATLAB host or the emulation target; often it can do little more than run a downloaded executable file.

When you use Simulink software to execute a model for which you will later generate code, or use Simulink Coder software to generate code for deployment on an *embedded* target, you must provide information about the embedded target hardware and the compiler that you will use with it. The Simulink software uses this information to produce bit-true agreement for the results of integer and fixed-point operations performed in simulation and in code generated for the embedded target. The Simulink Coder code generator uses the information to create code that executes with maximum efficiency.

When you generate code for testing on an *emulation* target, you must additionally provide information about the emulation target hardware and the compiler that you will use with it. The code generator uses this information to create code that provides bit-true agreement for the results of integer and fixed-point operations performed in simulation, in code generated for the embedded target, and in code generated for the emulation target. The agreement is possible even though the embedded target and emulation target may use very different hardware, and the compilers for the two targets may use different defaults where the C standard does not completely define behavior.

## Available Targets

The following table lists supported system target files and their associated code formats. The table also gives references to relevant manuals or chapters in this book. All of these targets are built using the `make_rtw` make command.

---

**Note** You can select any target of interest using the System Target File Browser. This allows you to experiment with configuration options and save your model with different configurations. However, you cannot build or generate code for non-GRT targets unless you have the required license on your system (Embedded Coder license for ERT, Real-Time Windows Target license for RTWIN, and so on).

---



Each system target file invokes one or more template makefiles. The template makefile that is invoked activates a particular compiler (for example, Lcc, gcc, or Watcom compilers). This is specified for you by MEXOPTS, which is determined when you run `mex -setup` to select a compiler for `mex`. One exception is the Microsoft Visual C++<sup>®</sup> project target, which has separate System Target File Browser entries.

**Targets Available from the System Target File Browser**

<b>Target/Code Format</b>	<b>System Target File</b>	<b>Template Makefile and Comments</b>	<b>Reference</b>
Embedded Coder (for PC or UNIX <sup>3</sup> platforms)	ert.tlc ert_shrlib.tlc	ert_default_tmf Use mex -setup to configure for Lcc, Watcom, vc, gcc, and other compilers	“Target” (Embedded Coder topic)
Embedded Coder for Visual C++ <sup>4</sup> Solution File	ert.tlc	RTW.MSVCBUILD Creates and builds Visual C++ Solution (.sln) file	“Target” (Embedded Coder topic)
Embedded Coder for AUTOSAR	autosar.tlc	ert_default_tmf	“Target” (Embedded Coder topic)
Generic Real-Time for PC or UNIX platforms	grt.tlc	grt_default_tmf Use mex -setup to configure for Lcc, Watcom, vc, gcc, and other compilers	“Targets and Code Formats” on page 9-29
Generic Real-Time for Visual C++ Solution File	grt.tlc	RTW.MSVCBUILD Creates and builds Visual C++ Solution (.sln) file	“Targets and Code Formats” on page 9-29

3. UNIX<sup>®</sup> is a registered trademark of The Open Group in the United States and other countries.

4. Visual C++<sup>®</sup> is a registered trademark of Microsoft<sup>®</sup> Corporation.

### Targets Available from the System Target File Browser (Continued)

Target/Code Format	System Target File	Template Makefile and Comments	Reference
Generic Real-Time (dynamic) for PC or UNIX platforms	grt_malloc.tlc	grt_malloc_default_tmf  Use mex -setup to configure for Lcc, Watcom, vc, gcc, and other compilers  Does not support SimStruct.	“Targets and Code Formats” on page 9-29
Generic Real-Time (dynamic) for Visual C++ Solution File	grt_malloc.tlc	RTW.MSVCCBuild  Creates and builds Visual C++ Solution (.sln) file	“Targets and Code Formats” on page 9-29
Rapid Simulation Target (default for PC or UNIX platforms)	rsim.tlc	rsim_default_tmf  Use mex -setup to configure	“Rapid Simulations” on page 12-2
Rapid Simulation Target for LCC compiler	rsim.tlc	rsim_lcc.tmf	“Rapid Simulations” on page 12-2
Rapid Simulation Target for UNIX platforms	rsim.tlc	rsim_unix.tmf	“Rapid Simulations” on page 12-2
Rapid Simulation Target for Visual C++ compiler	rsim.tlc	rsim_vc.tmf	“Rapid Simulations” on page 12-2
Rapid Simulation Target for Watcom compiler	rsim.tlc	rsim_watc.tmf	“Rapid Simulations” on page 12-2

**Targets Available from the System Target File Browser (Continued)**

<b>Target/Code Format</b>	<b>System Target File</b>	<b>Template Makefile and Comments</b>	<b>Reference</b>
S-Function Target for PC or UNIX platforms	rtwsfcn.tlc	rtwsfcn_default_tmf Use mex -setup to configure	“Generated S-Function Block” on page 12-34
S-Function Target for LCC	rtwsfcn.tlc	rtwsfcn_lcc.tmf	“Generated S-Function Block” on page 12-34
S-Function Target for UNIX platforms	rtwsfcn.tlc	rtwsfcn_unix.tmf	“Generated S-Function Block” on page 12-34
S-Function Target for Visual C++ compiler	rtwsfcn.tlc	rtwsfcn_vc.tmf	“Generated S-Function Block” on page 12-34
S-Function Target for Watcom	rtwsfcn.tlc	rtwsfcn_watc.tmf	“Generated S-Function Block” on page 12-34
Tornado (VxWorks) Real-Time Target	tornado.tlc	tornado.tmf	“Asynchronous Support” on page 1-35
ASAM-ASAP2 Data Definition Target	asap2.tlc	asap2_default_tmf	“ASAP2 Data Measurement and Calibration” on page 15-174
Real-Time Windows Target for Open Watcom	rtwin.tlc rtwinert.tlc	rtwin.tmf rtwinert.tmf	“Use Simulink Models” (Real-Time Windows Target topic)
xPC Target for Visual C++ or Watcom C/C++ compilers	xpctarget.tlc xpctargetert.tlc	xpc_default_tmf xpc_ert_tmf xpc_vc.tmf xpc_watc.tmf	“xPC Target Options Configuration Parameter” (xPC Target topic)
IDE Link capability	idelink_grt.tlc idelink_ert.tlc	N/A	Desktop IDE/target topics such as “Model Setup” on page 25-2; Embedded IDE/target topics such as “Model Setup” (Embedded Coder topic)

## Targets Supporting Nonzero Start Time

When you try to build models with a nonzero start time, if the selected target does not support a nonzero start time, the Simulink Coder software does not generate code and displays an error message. The Rapid Simulation (RSim) target supports a nonzero start time when the **RSim Target > Solver selection** parameter in the Configuration Parameters dialog box is set to `Use Simulink solver module`. The other listed targets do not support a nonzero start time.

## About Targets and Code Formats

A *target* (such as the GRT target) is an environment for generating and building code intended for execution on a certain hardware or operating system platform. A target is defined at the top level by a system target file, which in turn invokes other target-specific files.

A *code format* (such as embedded or real-time) is one property of a target. The code format controls decisions made at several points in the code generation process. These include whether and how certain data structures are generated (for example, `SimStruct` or `rtModel`), whether or not static or dynamic memory allocation code is generated, and the calling interface used for generated model functions. In general, the Embedded-C code format is more efficient than the `RealTime` code format. Embedded-C code format provides more compact data structures, a simpler calling interface, and static memory allocation. These characteristics make the Embedded-C code format the preferred choice for production code generation.

In prior releases, only the ERT target and targets derived from the ERT target used the Embedded-C code format. Non-ERT targets used other code formats (for example, `RealTime` or `RealTimeMalloc`).

In Release 14, the GRT target uses the Embedded-C code format for back end code generation. This includes generation of both algorithmic model code and supervisory timing and task scheduling code. The GRT target (and derived targets) generates a `RealTime` code format wrapper around the Embedded-C code. This wrapper provides a calling interface that is backward compatible with existing GRT-based custom targets. The wrapper calls are compatible with the main program module of the GRT target (`grt_main.c` or `grt_main.cpp`). This use of wrapper calls incurs some calling overhead;

the pure Embedded-C calling interface generated by the ERT target is more highly optimized.

For a description of the calling interface generated by the ERT target, see “Entry Point Functions and Scheduling”.

Code format unification simplifies the conversion of GRT-based custom targets to ERT-based targets. See “Making Pre-R2012a Custom GRT-Based Targets ERT-Compatible” on page 9-26 for a discussion of target conversion issues.

## Types of Target Code Formats

- “Real-Time Code Format” on page 9-20
- “Real-Time malloc Code Format” on page 9-21
- “S-Function Code Format” on page 9-23
- “Embedded Code Format” on page 9-23

Your choice of code format is the most important code generation option. The code format specifies the overall framework of the generated code and determines its style.

When you choose a target, you implicitly choose a code format. Typically, the system target file will specify the code format by assigning the TLC variable `CodeFormat`. The following example is from `ert.tlc`.

```
%assign CodeFormat = "Embedded-C"
```

If the system target file does not assign `CodeFormat`, the default is `RealTime` (as in `grt.tlc`).

If you are developing a custom target, you must consider which code format is best for your application and assign `CodeFormat` accordingly.

Choose the `RealTime` or `RealTime_malloc` code format for rapid prototyping. If your application does not have significant restrictions in code size, memory usage, or stack usage, you might want to continue using the generic real-time (GRT) target throughout development.

For production deployment, and when your application demands that you limit source code size, memory usage, or maintain a simple call structure, you should use the Embedded-C code format. Consider using the Embedded Coder product, if you need added flexibility to configure and optimize code.

Finally, you should choose the Model Reference or the S-function formats if you are not concerned about RAM and ROM usage and want to

- Use a model as a component, for scalability
- Create a proprietary S-function MEX-file object
- Interface the generated code using the S-function C API
- Speed up your simulation

The following table summarizes how different targets support applications:

<b>Application</b>	<b>Targets</b>
Fixed- or variable-step acceleration	RSIM, S-Function, Model Reference
Fixed-step real-time deployment	GRT, GRT-Malloc, ERT, xPC Target, Wind River Systems Tornado, Real-Time Windows Target, Texas Instruments™ DSP, ...

The following table summarizes the various options available for each Simulink Coder code format/target, with the exceptions noted.

**Features Supported by Simulink Coder Targets and Code Formats**

<b>Feature</b>	<b>GRT</b>	<b>Real-time malloc</b>	<b>ERT</b>	<b>ERT Shared Library</b>	<b>Wind River Systems VxWorks /Tornado</b>	<b>S-Func</b>	<b>RSIM</b>	<b>RT Win</b>	<b>xPC</b>	<b>Other Supported Targets<sup>1</sup></b>
Static memory allocation	X		X		X			X	X	X
Dynamic memory allocation		X			X	X	X		X	
Continuous time	X	X	X		X	X	X	X	X	
C/C++ MEX S-functions (noninlined)	X	X	X		X	X	X	X	X	
S-function (inlined)	X	X	X		X	X	X	X	X	X
Minimize RAM/ROM usage			X		X <sup>2</sup>				X <sup>2</sup>	X
Supports external mode	X	X	X		X		X	X	X	
Rapid prototyping	X	X			X			X	X	X
Production code			X		X <sup>2</sup>				X <sup>2</sup>	X <sup>3</sup>



### Features Supported by Simulink Coder Targets and Code Formats (Continued)

Feature	GRT	Real-time malloc	ERT	ERT Shared Library	Wind River Systems VxWorks /Tornado	S-Func	RSIM	RT Win	xPC	Other Supported Targets <sup>1</sup>
Batch parameter tuning and Monte Carlo methods				X			X			
System-level Simulator				X						
Executes in hard real time	X <sup>4</sup>	X <sup>4</sup>	X <sup>4</sup>		X			X	X	X <sup>5</sup>
Non-real-time executable included	X	X	X				X			
Multiple instances of model		X <sup>6</sup>	X <sup>6, 7</sup>			X <sup>6</sup>			X <sup>2, 6, 7</sup>	X <sup>2, 6, 7</sup>
Supports variable-step solvers						X	X			
Supports SIL/PIL			X							X

<sup>1</sup>The Embedded Targets capabilities in Simulink Coder support other targets.

<sup>2</sup>Does not apply to GRT based targets. Applies only to an ERT based target.

<sup>4</sup>The default GRT, GRT malloc, and ERT `rt_main` files emulate execution of hard real time, and when explicitly connected to a real-time clock execute in hard real time.

<sup>6</sup>You can generate code for multiple instances of a Stateflow chart or subsystem containing a chart, except when the chart contains exported graphical functions or the Stateflow model contains machine parented events.

<sup>7</sup>You must enable **Generate reusable code** in the **Code Generation > Interface** pane of the Configuration Parameters dialog box.

## Real-Time Code Format

- “About Real-Time Code Format” on page 9-20
- “Unsupported Blocks” on page 9-20
- “System Target Files” on page 9-21
- “Template Makefiles” on page 9-21

**About Real-Time Code Format.** The real-time code format (corresponding to the generic real-time target) is useful for rapid prototyping applications. If you want to generate real-time code while iterating model parameters rapidly, you should begin the design process with the generic real-time target. The real-time code format supports:

- Continuous time
- Continuous states
- C/C++ MEX S-functions (inlined and noninlined)

For more information on inlining S-functions, see “Insert S-Function Code” on page 14-46 and “Inlining S-Functions”.

The real-time code format declares memory statically, that is, at compile time.

**Unsupported Blocks.** The real-time format does not support the following built-in user-defined blocks:

- Interpreted MATLAB Function block (note that Fcn blocks *are* supported)

- S-Function block — MATLAB language S-functions, Fortran S-functions, or C/C++ MEX S-functions that call into the MATLAB environment (Fcn block calls *are* supported)

### **System Target Files.**

- grt.tlc - Generic Real-Time Target
- rsim.tlc - Rapid Simulation Target
- tornado.tlc - Tornado (VxWorks) Real-Time Target

### **Template Makefiles.**

- grt
  - grt\_lcc.tmf — Lcc compiler
  - grt\_unix.tmf — The Open Group UNIX host
  - grt\_vc.tmf — Microsoft Visual C++
  - grt\_watc.tmf — Watcom C
- rsim
  - rsim\_lcc.tmf — Lcc compiler
  - rsim\_unix.tmf — UNIX host
  - rsim\_vc.tmf — Visual C++
  - rsim\_watc.tmf — Watcom C
- tornado.tmf
- win\_watc.tmf

### **Real-Time malloc Code Format**

- “About Real-Time malloc Code Format” on page 9-22
- “Unsupported Blocks” on page 9-22
- “System Target Files” on page 9-22
- “Template Makefiles” on page 9-23

**About Real-Time malloc Code Format.** The real-time malloc code format (corresponding to the generic real-time malloc target) is very similar to the real-time code format. The differences are

- Real-time malloc declares memory dynamically.

For MathWorks blocks, malloc calls are limited to the model initialization code. Generated code is designed to be free from memory leaks, provided that the model termination function is called.

- Real-time malloc allows you to deploy multiple instances of the same model with each instance maintaining its own unique data.
- Real-time malloc allows you to combine multiple models together in one executable. For example, to integrate two models into one larger executable, real-time malloc maintains a unique instance of each of the two models. If you do not use the real-time malloc format, the Simulink Coder code generator will not necessarily create uniquely named data structures for each model, potentially resulting in name clashes.

grt\_malloc\_main.c (or .cpp), the main routine for the generic real-time malloc (grt\_malloc) target, supports one model by default. See “Use GRT Malloc to Combine Models” on page 4-4 for information on modifying grt\_malloc\_main.c (or .cpp) to support multiple models. grt\_malloc\_main.c and grt\_malloc\_main.cpp are located in the folder `matlabroot/rtw/c/grt_malloc`.

**Unsupported Blocks.** The real-time malloc format does not support the following built-in blocks, as shown:

- Functions & Tables
  - Interpreted MATLAB Function block (note that Fcn blocks *are* supported)
  - S-Function block — MATLAB language S-functions, Fortran S-functions, or C/C++ MEX S-functions that call into the MATLAB environment (Fcn block calls *are* supported)

### System Target Files.

- grt\_malloc.tlc - Generic Real-Time Target with dynamic memory allocation

- `tornado.tlc` - Tornado (VxWorks) Real-Time Target

### Template Makefiles.

- `grt_malloc`
  - `grt_malloc_lcc.tmf` — Lcc compiler
  - `grt_malloc_unix.tmf` — The Open Group UNIX host
  - `grt_malloc_vc.tmf` — Microsoft Visual C++
  - `grt_malloc_watc.tmf` — Watcom C
- `tornado.tmf`

### S-Function Code Format

The S-function code format (corresponding to the S-function target) generates code that conforms to the Simulink MEX S-function API. Using the S-function target, you can build an S-function component and use it as an S-Function block in another model.

The S-function code format is also used by the accelerated simulation target to create the Accelerator MEX-file.

In general, you should not use the S-function code format in a system target file. However, you might need to do special handling in your inlined TLC files to account for this format. You can check the TLC variable `CodeFormat` to see if the current target is a MEX-file. If `CodeFormat = "S-Function"` and the TLC variable `Accelerator` is set to 1, the target is an accelerated simulation MEX-file.

See “Generated S-Function Block” on page 12-34, for more information.

### Embedded Code Format

- “About Embedded Code Format” on page 9-24
- “Using the Real-Time Model Data Structure” on page 9-24
- “Making Pre-R2012a Custom GRT-Based Targets ERT-Compatible” on page 9-26

- “Converting Your Target to Use `rtModel`” on page 9-27
- “Generating Pre-R2012a GRT Wrapper Code” on page 9-29

**About Embedded Code Format.** The Embedded-C code format corresponds to the Embedded Coder target (ERT), and targets derived from ERT. This code format includes a number of memory-saving and performance optimizations. See the Embedded Coder “Product Description” and configuration topics such as “Application Objectives”, “Target”, and “Code Appearance” for details.

**Using the Real-Time Model Data Structure.** The Embedded-C format uses the real-time model (RT\_MODEL) data structure. This structure is also referred to as the `rtModel` data structure. You can access `rtModel` data by using a set of macros analogous to the `ssSetxxx` and `ssGetxxx` macros that S-functions use to access `SimStruct` data, including noninlined S-functions compiled by the Simulink Coder code generator.

You need to use the set of macros `rtmGetxxx` and `rtmSetxxx` to access the real-time model data structure, which is specific to the Simulink Coder product. The `rtModel` is an optimized data structure that replaces `SimStruct` as the top level data structure for a model. The `rtmGetxxx` and `rtmSetxxx` macros are used in the generated code as well as from the `main.c` or `main.cpp` module. If you are customizing `main.c` or `main.cpp` (either a static file or a generated file), you need to use `rtmGetxxx` and `rtmSetxxx` instead of the `ssSetxxx` and `ssGetxxx` macros.

Usage of `rtmGetxxx` and `rtmSetxxx` macros is the same as for the `ssSetxxx` and `ssGetxxx` versions, except that you replace `SimStruct S` by real-time model data structure `rtM`. The following table lists `rtmGetxxx` and `rtmSetxxx` macros that are used in `grt_main.c`, `grt_main.cpp`, `grt_malloc_main.c`, and `grt_malloc_main.cpp`.

### Macros for Accessing the Real-Time Model Data Structure

<b>rtm Macro Syntax</b>	<b>Description</b>
<code>rtmGetdX(rtM)</code>	Get the derivatives of a block’s continuous states
<code>rtmGetOffsetTimePtr(RT_MDL rtM)</code>	Return the pointer of vector that stores sample time offsets of the model associated with <code>rtM</code>

## Macros for Accessing the Real-Time Model Data Structure (Continued)

<b>rtm Macro Syntax</b>	<b>Description</b>
<code>rtmGetNumSampleTimes(RT_MDL rtM)</code>	Get the number of sample times that a block has
<code>rtmGetPerTaskSampleHitsPtr(RT_MDL)</code>	Return a pointer of NumSampleTime × NumSampleTime matrix
<code>rtmGetRTWExtModeInfo(RT_MDL rtM)</code>	Return an external mode information data structure of the model. This data structure is used internally for external mode.
<code>rtmGetRTWLogInfo(RT_MDL)</code>	Return a data structure used by Simulink Coder logging. Internal use.
<code>rtmGetRTWRTModelMethodsInfo(RT_MDL)</code>	Return a data structure of Simulink Coder real-time model methods information. Internal use.
<code>rtmGetRTWSolverInfo(RT_MDL)</code>	Return data structure containing solver information of the model. Internal use.
<code>rtmGetSampleHitPtr(RT_MDL)</code>	Return a pointer of Sample Hit flag vector
<code>rtmGetSampleTime(RT_MDL rtM, int TID)</code>	Get a task's sample time
<code>rtmGetSampleTimePtr(RT_MDL rtM)</code>	Get pointer to a task's sample time
<code>rtmGetSampleTimeTaskIDPtr(RT_MDL rtM)</code>	Get pointer to a task's ID
<code>rtmGetSimTimeStep(RT_MDL)</code>	Return simulation step type ID (MINOR_TIME_STEP, MAJOR_TIME_STEP)
<code>rtmGetStepSize(RT_MDL)</code>	Return the fundamental step size of the model
<code>rtmGetT(RT_MDL, t)</code>	Get the current simulation time
<code>rtmSetT(RT_MDL, t)</code>	Set the time of the next sample hit
<code>rtmGetTaskTime(RT_MDL, tid)</code>	Get the current time for the current task
<code>rtmGetTTFinal(RT_MDL)</code>	Get the simulation stop time
<code>rtmSetTTFinal(RT_MDL, finalT)</code>	Set the simulation stop time
<code>rtmGetTimingData(RT_MDL)</code>	Return a data structure used by timing engine of the model. Internal use.

## Macros for Accessing the Real-Time Model Data Structure (Continued)

rtm Macro Syntax	Description
<code>rtmGetTPtr(RT_MDL)</code>	Return a pointer of the current time
<code>rtmGetTStart(RT_MDL)</code>	Get the simulation start time
<code>rtmIsContinuousTask(rtm)</code>	Determine whether a task is continuous
<code>rtmIsMajorTimeStep(rtm)</code>	Determine whether the simulation is in a major step
<code>rtmIsSampleHit(RT_MDL, tid)</code>	Determine whether the sample time is hit

For additional details on usage, see “SimStruct Macros and Functions Listed by Usage”.

**Making Pre-R2012a Custom GRT-Based Targets ERT-Compatible.** If you developed a GRT-based custom target in a release before R2012a, it is simple to make your target ERT compatible. By doing so, you can take advantage of many efficiencies.

There are several approaches to ERT compatibility:

- If your installation does not include an Embedded Coder license, you can convert a GRT-based target as described in “Converting Your Target to Use `rtModel`” on page 9-27. This enables your custom target to support current GRT features, including back end Embedded-C code generation.
- If your installation includes an Embedded Coder license, you can do either of the following:
  - Create an ERT-based target, but continue to use your customized version of `grt_main.c` or `grt_main.cpp` module. To do this, you can configure the ERT target to generate a pre-R2012a GRT calling interface, as described in “Generating Pre-R2012a GRT Wrapper Code” on page 9-29. This lets your target support the full ERT feature set, without changing your GRT-based run-time interface.
  - Reimplement your custom target as a completely ERT-based target, including use of an ERT generated main program. This approach lets



your target support the full ERT feature set, without the overhead caused by wrapper calls.

---

**Note** If you intend to use custom storage classes (CSCs) with a custom target, you must use an ERT-based target. See “Custom Storage Classes” in the Embedded Coder documentation for detailed information on CSCs.

---

For details on how GRT targets are made call-compatible with previous Simulink Coder product versions, see “Using the Real-Time Model Data Structure” on page 9-24.

**Converting Your Target to Use `rtModel`.** The real-time model data structure (`rtModel`) encapsulates model-specific information in a much more compact form than the `SimStruct`. Many ERT-related efficiencies depend on generation of `rtModel` rather than `SimStruct`, including

- Integer absolute and elapsed timing services
- Independent timers for asynchronous tasks
- Generation of improved C API code for signal, state, and parameter monitoring
- Pruning the data structure to minimize its size (ERT-derived targets only)

To take advantage of such efficiencies, you must update your GRT-based target to use the `rtModel` (unless you already did so for Release 13). The conversion requires changes to your system target file, template makefile, and main program module.

The following changes to the system target file and template makefile are required to use `rtModel` instead of `SimStruct`:

- In the system target file, add the following global variable assignment:

```
%assign GenRTModel = TLC_TRUE
```

- In the template makefile, define the symbol `USE_RTMODEL`. See one of the GRT template makefiles for an example.

The following changes to your main program module (that is, your customized version of `grt_main.c` or `grt_main.cpp`) are required to use `rtModel` instead of `SimStruct`:

- Include `rtmodel.h` instead of `simstruc.h`.
- Since the `rtModel` data structure has a type that includes the model name, define the following macros at the top of the main program file:

```
#define EXPAND_CONCAT(name1,name2) name1 ## name2
#define CONCAT(name1,name2) EXPAND_CONCAT(name1,name2)
#define RT_MODEL CONCAT(MODEL,_rtModel)
```

- Change the extern declaration for the function that creates and initializes the `SimStruct` to

```
extern RT_MODEL *MODEL(void);
```

- Change the definitions of `rt_CreateIntegrationData` and `rt_UpdateContinuousStates` to be as shown in the Release 14 version of `grt_main.c`.
- Change function prototypes to have the argument '`RT_MODEL`' instead of the argument '`SimStruct`'.
- The prototypes for the functions `rt_GetNextSampleHit`, `rt_UpdateDiscreteTaskSampleHits`, `rt_UpdateContinuousStates`, `rt_UpdateDiscreteEvents`, `rt_UpdateDiscreteTaskTime`, and `rt_InitTimingEngine` have changed. Change their names to use the prefix `rt_Sim` instead of `rt_` and then change the arguments you pass in to them. See the Release 14 version of `grt_main.c` for the list of arguments passed in to each function.
- Modify all macros that refer to the `SimStruct` to now refer to the `rtModel`. `SimStruct` macros begin with the prefix `ss`, whereas `rtModel` macros begin with the prefix `rtm`. For example, change `ssGetErrorStatus` to `rtmGetErrorStatus`.

**Generating Pre-R2012a GRT Wrapper Code.** The Simulink Coder product supports the “**Classic call interface**” model option. When this option is selected, the Simulink Coder product generates model function calls that are compatible with the main program module of the pre-R2012a GRT target (`grt_main.c` or `grt_main.cpp`). These calls act as wrappers that interface to code generated with R2012a or higher.

This option provides a quick way to use code generated with R2012a or higher with a main program module based on pre-R2012a `grt_main.c` or `grt_main.cpp`.

## Targets and Code Formats

The Simulink Coder product provides five different *code formats*. Each code format specifies a framework for code generation suited for specific applications. The five code formats and corresponding application areas are

- **Real-time** — Rapid prototyping
- **Real-time malloc** — Rapid prototyping
- **S-function** — Creating proprietary S-function MEX-file objects, code reuse, and speeding up your simulation
- **Model reference** — Creating MEX-file objects from entire models that other models can use, sometimes in place of S-functions
- **Embedded C** — Deeply embedded systems

This chapter discusses the relationship of code formats to the available target configurations, and factors you should consider when choosing a code format and target. This chapter also summarizes the real-time, real-time malloc, S-function, model referencing, and embedded C/C++ code formats.

## Targets and Code Styles

The Simulink Coder software generates two styles of code. One code style is suitable for rapid prototyping (and simulation by using code generation). The other style is suitable for embedded applications. This chapter discusses the program architecture, that is, the structure of code generated by the Simulink Coder code generator, associated with these two styles of code. The next table classifies the targets shipped with the product. For related details about

code style and target characteristics, see “Types of Target Code Formats” on page 9-16.

### Code Styles Listed by Target

Target	Code Style (Using C or C++ Unless Noted)
Embedded Coder embedded real-time (ERT) target	Embedded — Useful as a starting point when using generated C/C++ code in an embedded application (often referred to as a <i>production code target</i> ).
Simulink Coder Generic real-time (GRT) target	Rapid prototyping — Use as a starting point for creating a rapid prototyping target that does not use real-time operating system tasking primitives, and for verifying the generated code on your workstation. Uses components of ERT, with a different calling interface.
Real-time malloc target	Rapid prototyping — Similar to the generic real-time (GRT) target except that this target allocates model working memory dynamically rather than statically declaring it in advance.
Rapid simulation target (RSim)	Rapid prototyping — Non-real-time simulation of your model on your workstation. Useful as a high-speed or batch simulation tool.
S-function target	Rapid prototyping — Creates a C MEX S-function for simulation of your model within another Simulink model.
Tornado (VxWorks) real-time target <sup>5</sup>	Rapid prototyping — Runs model in real time using the VxWorks real-time operating system tasking primitives. Also useful as a starting point for targeting a real-time operating system.

5. Tornado® and VxWorks® are registered trademarks of Wind River® Systems, Inc.

## Code Styles Listed by Target (Continued)

Target	Code Style (Using C or C++ Unless Noted)
Real-Time Windows Target	Rapid prototyping — Runs model in real time at interrupt level while your PC is running a Microsoft Windows environment in the background.
xPC Target	Rapid prototyping — Runs model in real time on target PC running the xPC Target kernel.

Third-party vendors supply additional targets for the Simulink Coder product. Generally, these can be classified as rapid prototyping targets. For more information about third-party products, see the MathWorks Connections Program Web page: <http://www.mathworks.com/products/connections>.

This chapter is divided into three sections. The first section discusses model execution, the second section discusses the rapid prototyping style of code, and the third section discusses the embedded style of code.

## Backwards Compatibility of Code Formats

Because GRT targets now use Embedded-C code format, existing applications that depend on the RealTime code format's calling interface could have compatibility issues. To address this, a set of macros is generated (in *model.h*) that maps Embedded-C data structures to the identifiers that RealTime code format used. The following, which can be found in any *model.h* file created for a GRT target, describes these identifier mappings:

```

/* Backward compatible GRT Identifiers */
#define rtB                               model_B
#define BlockIO                           BlockIO_model
#define rtXdot                             model_Xdot
#define StateDerivatives                  StateDerivatives_model
#define tXdis                              model_Xdis
#define StateDisabled                     StateDisabled_model
#define rtY                               model_Y
#define ExternalOutputs                   ExternalOutputs_model
#define rtP                               model_P
#define Parameters                        Parameters_model

```

Since the GRT target now uses the Embedded-C code format for back end code generation, many Embedded-C optimizations are available to all Simulink Coder users. In general, the GRT and ERT targets now have many more common features, but the ERT target offers additional controls for common features. The availability of features is now determined by licensing, rather than being tied to code format. The following table compares features available with a Simulink Coder license with those available under an Embedded Coder license:

### Comparison of Features Licensed with the Simulink Coder Product Versus the Embedded Coder Product

Feature	Simulink Coder License	Embedded Coder License
rtModel data structure	<ul style="list-style-type: none"> <li>• Full rtModel structure generated</li> <li>• GRT variable declaration: <code>rtModel_model model_M;</code></li> </ul>	<ul style="list-style-type: none"> <li>• rtModel is optimized for the model</li> <li>• Optional suppression of error status field and data logging fields</li> <li>• ERT variable declaration: <code>RT_MODEL_model model_M;</code></li> </ul>
Custom storage classes (CSCs)	Code generation ignores CSCs; objects are assigned a CSC default to Auto storage class	Code generation with CSCs is supported
HTML code generation report	Basic HTML code generation report	Enhanced report with additional detail and hyperlinks to the model
Symbol formatting	Symbols (for signals, parameters and so on) are generated in accordance with hard-coded default	Detailed control over generated symbols.
User-defined maximum identifier length for generated symbols	Supported	Supported
Generation of terminate function	Always generated	Option to suppress terminate function

## Comparison of Features Licensed with the Simulink Coder Product Versus the Embedded Coder Product (Continued)

Feature	Simulink Coder License	Embedded Coder License
Combined output/update function	Separate output/update functions are generated	Option to generate combined output/update function
Optimized data initialization	Not available	Options to suppress generation of unnecessary initialization code for zero-valued memory, I/O ports, and so on
Comments generation	Basic options to include or suppress comment generation	Options to include Simulink block descriptions, Stateflow object descriptions, and Simulink data object descriptions in comments
Module Packaging Features (MPF)	Not supported	Extensive code customization features (see Embedded Coder topics such as “Data Types”, “User-Defined Data Types”, and “Custom Storage Classes”.)
Target-optimized data types header file	Requires full <code>tmwtypes.h</code> header file	Generates optimized <code>rtwtypes.h</code> header file, including definitions required by the target
User-defined types	User-defined types default to base types in code generation	User defined data type aliases are supported in code generation
Rate grouping	Not supported	Supported
Auto-generation of main program module	Not supported; static main program module is provided.	Automated and customizable generation of main program module is supported (static main program also available)
Reusable (multi-instance) code generation with static memory allocation	Not supported	Option to generate reusable code

## Comparison of Features Licensed with the Simulink Coder Product Versus the Embedded Coder Product (Continued)

Feature	Simulink Coder License	Embedded Coder License
Software constraint options	Support for floating point, complex, and nonfinite numbers is always enabled	Options to enable or disable support for floating-point, complex, and nonfinite numbers
Application life span	Defaults to inf	User-specified; determines most efficient word size for integer timers
Software-in-the-loop (SIL) testing	Model reference simulation target can be used for SIL testing	Additional SIL testing support by using auto-generation of SIL block
ANSI <sup>6</sup> -C/C++ code generation	Supported	Supported
ISO <sup>7</sup> -C/C++ code generation	Supported	Supported
GNU <sup>8</sup> -C/C++ code generation	Supported	Supported
Generate scalar inlined parameters as #DEFINE statements	Not supported	Supported
MAT-file variable name modifier	Supported	Supported
Data exchange: C API, external mode, ASAP2	Supported	Supported

### Selecting a Target

The first step to configuring a model for Simulink Coder code generation is to choose and configure a code generation target. When you select a target,

6. ANSI<sup>®</sup> is a registered trademark of the American National Standards Institute, Inc.
7. ISO<sup>®</sup> is a registered trademark of the International Organization for Standardization.
8. GNU<sup>®</sup> is a registered trademark of the Free Software Foundation.



other model configuration parameters change automatically to best serve requirements of the target. For example:

- Code interface parameters
- Build process parameters, such as the template make file
- Target hardware parameters, such as word size and byte ordering

Use the **Browse** button on the **Code Generation** pane to open the System Target File Browser. The browser lets you select a preset target configuration consisting of a system target file, template makefile, and make command. For a complete list of available target configurations, see “Available Targets” on page 9-10.

If you select a target configuration by using the System Target File Browser, your selection appears in the **System target file** field (*target.tlc*).

If you are using a target configuration that does not appear in the System Target File Browser, enter the name of your system target file in the **System target file** field. Click **Apply** or **OK** to configure for that target.

You also can select a target programmatically from MATLAB code, as described in “Selecting a System Target File Programmatically” on page 9-37.

After selecting a target, you can modify model configuration parameter settings.

If you want to switch between different targets in a single workflow for different code generation purposes (for example, rapid prototyping versus product code deployment), set up different configuration sets for the same model and switch the active configuration set for the current operation. For more information on how to set up configuration sets and change the active configuration set, see “Manage a Configuration Set” in the Simulink documentation.

To select a target configuration using the System Target File Browser,

- 1 Open the **Code Generation** pane of the Configuration Parameters dialog box.

- Click the **Browse** button next to the **System target file** field. This opens the System Target File Browser. The browser displays a list of currently available target configurations, including customizations. When you select a target configuration, the Simulink Coder software automatically chooses the system target file, template makefile, and make command for that configuration.

The next step shows the System Target File Browser with the generic real-time target selected.

- Click the desired entry in the list of available configurations. The background of the list box turns yellow to indicate an unapplied choice has been made. To apply it, click **Apply** or **OK**.

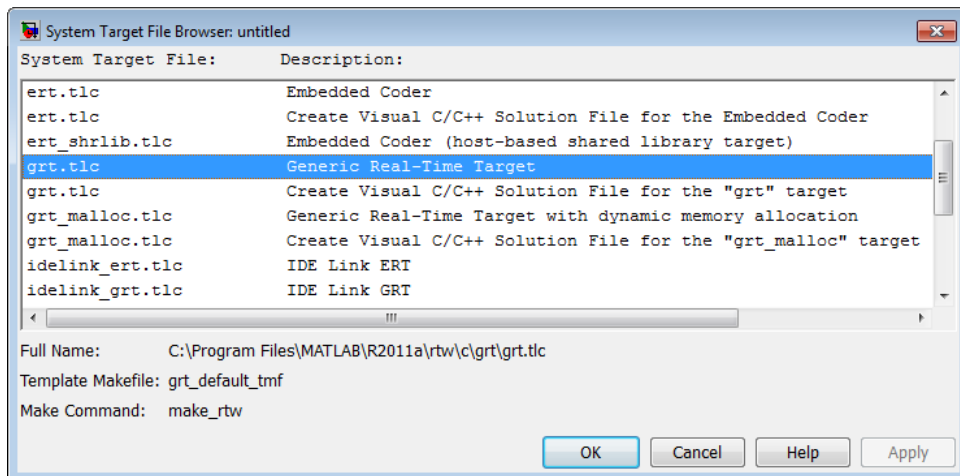

### System Target File Browser

When you choose a target configuration, the Simulink Coder software automatically chooses the system target file, template makefile, and make command for that configuration, and displays them in the **System target file** field. The description of the target file from the browser is placed below its name in the **Code Generation** pane.

## Selecting a System Target File Programmatically

Simulink models store model-wide parameters and target-specific data in *configuration sets*. Every configuration set contains a component that defines the structure of a particular target and the current values of target options. Some of this information is loaded from a system target file when you select a target using the System Target File Browser. You can configure models to generate alternative target code by copying and modifying old or adding new configuration sets and browsing to select a new target. Subsequently, you can interactively select an active configuration from among these sets (only one configuration set can be active at a given time).

Scripts that automate target selection need to emulate this process.

To program target selection

- 1** Obtain a handle to the active configuration set with a call to the `getActiveConfigSet` function.
- 2** Define string variables that correspond to the required Simulink Coder system target file, template makefile, and make command settings. For example, for the ERT target, you would define variables for the strings `'ert.tlc'`, `'ert_default_tmf'`, and `'make_rtw'`.
- 3** Select the system target file with a call to the `switchTarget` function. In the function call, specify the handle for the active configuration set and the system target file.
- 4** Set the `TemplateMakefile` and `MakeCommand` configuration parameters to the corresponding variables created in step 2.

For example:

```
cs = getActiveConfigSet(model);
stf = 'ert.tlc';
tmf = 'ert_default_tmf';
mc = 'make_rtw';
switchTarget(cs,stf,[]);
set_param(cs,'TemplateMakefile',tmf);
set_param(cs,'MakeCommand',mc);
```

## Template Makefiles and Make Options

The Simulink Coder product includes a set of built-in template makefiles that are designed to build programs for specific targets.

There are two types of template makefiles:

- *Compiler-specific* template makefiles are designed for use with a particular compiler or development system.

By convention, compiler-specific template makefiles are named according to the target and compiler (or development system). For example, `grt_vc.tmf` is the template makefile for building a generic real-time program under the Visual C++ compiler; `ert_lcc.tmf` is the template makefile for building an Embedded Coder program under the Lcc compiler.

- *Default* template makefiles make your model designs more portable, by choosing the compiler-specific makefile and compiler for your installation. “Choose and Configure a Compiler” on page 15-2 describes the operation of default template makefiles in detail.

Default template makefiles are named *target\_default\_tmf*. They are MATLAB language files that, when run, select the TMF for the specified target configuration. For example, `grt_default_tmf` is the default template makefile for building a generic real-time program; `ert_default_tmf` is the default template makefile for building an Embedded Coder program.

You can supply options to makefiles by using arguments to the **Make command** field in the **Code Generation** pane of the Configuration Parameters dialog box. Append the arguments after `make_rtw` (or `make_xpc` or other `make` command), as in the following example:

```
make_rtw OPTS="-DMYDEFINE=1"
```

The syntax for `make` command options differs slightly for different compilers.

Complete details on the structure of template makefiles are provided in the Embedded Coder documentation. This information is provided for those who want to customize template makefiles. This section describes compiler-specific template makefiles and common options you can use with each.

---

**Note** To control compiler optimizations for your Simulink Coder makefile build at the Simulink GUI level, use the **Compiler optimization level** option on the **Code Generation** pane of the Configuration Parameters dialog box. The **Compiler optimization level** option provides

- Target-independent values `Optimizations on` (faster runs) and `Optimizations off` (faster builds), which allow you to easily toggle compiler optimizations on and off during code development
- The value `Custom` for entering custom compiler optimization flags at Simulink GUI level (rather than at other levels of the build process)

If you specify compiler options for your Simulink Coder makefile build using `OPT_OPTS`, `MEX_OPTS` (except `MEX_OPTS="-v"`), or `MEX_OPT_FILE`, the value of **Compiler optimization level** is ignored and a warning is issued about the ignored parameter.

---

## Template Makefiles for UNIX Platforms

The template makefiles for UNIX platforms are designed to be used with the Free Software Foundation's GNU Make. These makefile are set up to conform to the guidelines specified in the IEEE<sup>®9</sup> Std 1003.2-1992 (POSIX) standard.

- `ert_unix.tmf`
- `grt_malloc_unix.tmf`
- `grt_unix.tmf`
- `rsim_unix.tmf`
- `rtwsfcn_unix.tmf`

You can supply options by using arguments to the `make` command.

- `OPTS` — User-specific options, for example,

```
make_rtw OPTS="-DMYDEFINE=1"
```

---

9. IEEE<sup>®</sup> is a registered trademark of The Institute of Electrical and Electronics Engineers, Inc.

- `OPT_OPTS`— Optimization options. Default is `-O`. To enable debugging specify as `OPT_OPTS=-g`. Because of optimization problems in IBM\_RS, the default is no optimization.
- `CPP_OPTS` — C++ compiler options.
- `USER_SRCS` — Additional user sources, such as files used by S-functions.
- `USER_INCLUDES` — Additional include paths, for example,

```
USER_INCLUDES=" -Iwhere-ever -Iwhere-ever2"
```

These options are also documented in the comments at the head of the respective template makefiles.

### **Template Makefiles for the Microsoft Visual C++ Compiler**

The Simulink Coder product offers two sets of template makefiles designed for use with the Visual C++ compiler.

To build an executable within the Simulink Coder build process, use one of the `target_vc.tmf` template makefiles:

- `ert_vc.tmf`
- `grt_malloc_vc.tmf`
- `grt_vc.tmf`
- `rsim_vc.tmf`
- `rtwsfcn_vc.tmf`

You can supply options by using arguments to the `make` command.

- `OPT_OPTS` — Optimization option. Default is `-O2`. To enable debugging specify as `OPT_OPTS=-Zi`.
- `OPTS` — User-specific options.
- `CPP_OPTS` — C++ compiler options.
- `USER_SRCS` — Additional user sources, such as files used by S-functions.
- `USER_INCLUDES` — Additional include paths, for example,

```
USER_INCLUDES=" -Iwhere-ever -Iwhere-ever2"
```

These options are also documented in the comments at the head of the respective template makefiles.

**Visual C++ Code Generation Only.** To create a Visual C++ project makefile (*model.mak*) without building an executable, use one of the *target\_msvc.tmf* template makefiles:

- *ert\_msvc.tmf*
- *grt\_malloc\_msvc.tmf*
- *grt\_msvc.tmf*

These template makefiles are designed to be used with *nmake*, which is bundled with the Visual C++ compiler.

You can supply the following options by using arguments to the *nmake* command:

- *OPTS* — User-specific options, for example,

```
make_rtw OPTS="/D MYDEFINE=1"
```

- *USER\_SRCS* — Additional user sources, such as files used by S-functions.
- *USER\_INCLUDES* — Additional include paths, for example,

```
USER_INCLUDES=" -Iwhere-ever -Iwhere-ever2"
```

These options are also documented in the comments at the head of the respective template makefiles.

### Template Makefiles for the Watcom C/C++ Compiler

The Simulink Coder product provides template makefiles to create an executable for the Microsoft Windows platform using Watcom C/C++. These template makefiles are designed to be used with *wmake*, which is bundled with Watcom C/C++.

---

**Note** The Watcom C compiler is no longer available from the manufacturer. However, the Simulink Coder product continues to ship with Watcom-related template makefiles.

---

- `ert_watc.tmf`
- `grt_malloc_watc.tmf`
- `grt_watc.tmf`
- `rsim_watc.tmf`
- `rtwsfcn_watc.tmf`

You can supply options by using arguments to the `make` command. Note that the location of the quotes is different from the other compilers and make utilities discussed in this chapter.

- `OPTS` — User-specific options, for example,

```
make_rtw "OPTS=-DMYDEFINE=1"
```

- `OPT_OPTS` — Optimization options. The default optimization option is `-oxat`. To turn off optimization and add debugging symbols, specify the `-d2` compiler switch in the `make` command, for example,

```
make_rtw "OPT_OPTS=-d2"
```

- `CPP_OPTS` — C++ compiler options.
- `USER_OBJS` — Additional user objects, such as files used by S-functions.
- `USER_PATH` — The folder path to the source (`.c` or `.cpp`) files that are used to create any `.obj` files specified in `USER_OBJS`. Multiple paths must be separated with a semicolon. For example,

```
USER_PATH="path1;path2"
```

- `USER_INCLUDES` — Additional include paths, for example,

```
USER_INCLUDES="-Iinclude-path1 -Iinclude-path2"
```



These options are also documented in the comments at the head of the respective template makefiles.

## Template Makefiles for the LCC Compiler

The Simulink Coder product provides template makefiles to create an executable for the Windows platform using Lcc compiler Version 2.4 and GNU Make (gmake).

- `ert_lcc.tmf`
- `grt_lcc.tmf`
- `grt_malloc_lcc.tmf`
- `rsim_lcc.tmf`
- `rtwsfcn_lcc.tmf`

You can supply options by using arguments to the `make` command:

- `OPTS` — User-specific options, for example,  

```
make_rtw OPTS=" -DMYDEFINE=1 "
```
- `OPT_OPTS` — Optimization options. Default is none. To enable debugging, specify `-g4` in the `make` command:  

```
make_rtw OPT_OPTS=" -g4 "
```
- `CPP_OPTS` — C++ compiler options.
- `USER_SRCS` — Additional user sources, such as files used by S-functions.
- `USER_INCLUDES` — Additional include paths, for example,  

```
USER_INCLUDES=" -Iwhere-ever -Iwhere-ever2 "
```

For Lcc, have a `/` as file separator before the filename instead of a `\`, for example, `d:\work\proj1\myfile.c`.

These options are also documented in the comments at the head of the respective template makefiles.

## Enabling the Simulink Coder Software to Build When Path Names Contain Spaces

The Simulink Coder software is able to handle path names that include spaces. Spaces might appear in the path from several sources:

- Your MATLAB installation folder
- The current MATLAB folder in which you initiate a build
- A compiler you are using for a Simulink Coder build

If your work environment includes one or more of the preceding scenarios, use the following support mechanisms as they apply::

- Add the following code to your template makefile (.tmf):

```
ALT_MATLAB_ROOT          = |>ALT_MATLAB_ROOT<|
ALT_MATLAB_BIN           = |>ALT_MATLAB_BIN<|
!if "$(MATLAB_ROOT)" != "$(ALT_MATLAB_ROOT)"
MATLAB_ROOT = $(ALT_MATLAB_ROOT)
!endif
!if "$(MATLAB_BIN)" != "$(ALT_MATLAB_BIN)"
MATLAB_BIN = $(ALT_MATLAB_BIN)
!endif
```

This code replaces `MATLAB_ROOT` with `ALT_MATLAB_ROOT` when the values of the two tokens are not equal, indicating the path for your MATLAB installation folder includes spaces. Likewise, `ALT_MATLAB_BIN` replaces `MATLAB_BIN`.

Note the preceding code is specific to `nmake`. See the supplied Simulink Coder template make files for platform-specific examples.

- When using operating system commands, such as `system` or `dos`, enclose path that specify executables or command parameters in double quotes (" "). For example,

```
system('dir "D:\Applications\Common Files"')
```

## Custom Targets

You can create your own system target files to build custom targets that interface with external code or operating environments.

See “About Embedded Target Development” on page 24-2 and the topics it references for details and examples showing how to make your custom targets appear in the System Target File Browser and display relevant controls in panes of the Configuration Parameters dialog box.

## Describing the Emulation and Embedded Targets

The Configuration Parameters dialog **Hardware Implementation** pane provides options that you can use to describe hardware properties, such as data size and byte ordering, and compiler behavior details that may vary with the compiler, such as integer rounding. The **Hardware Implementation** pane contains two subpanes:

- **Embedded Hardware** — Describes the embedded target hardware and the compiler that you will use with it. This information affects both simulation and code generation.
- **Emulation Hardware** — Describes the emulation target hardware and the compiler that you will use with it. This information affects only code generation.

The two subpanes provide identical options and value choices. By default, the **Embedded Hardware** subpane initially looks like this:

The screenshot shows the "Embedded hardware (simulation and code generation)" subpane. It includes the following controls:

- Device vendor:** A dropdown menu set to "Generic".
- Device type:** A dropdown menu set to "Unspecified (assume 32-bit Generic)".
- Number of bits:** A grid of input fields for data types:
 

char:	8	short:	16	int:	32
long:	32	float:	32	double:	64
native:	32	pointer:	32		
- Largest atomic size:** A dropdown menu set to "Char".
- floating-point:** A dropdown menu set to "None".
- Byte ordering:** A dropdown menu set to "Unspecified".
- Signed integer division rounds to:** A dropdown menu set to "Undefined".
- Shift right on a signed integer as arithmetic shift

The default assumption is that the embedded target and emulation target are the same, so the **Emulation Hardware** subpane by default does not need to specify anything and contains only a checked option labeled **None**. Code generated under this configuration will be suitable for production use, or for testing in an environment identical to the production environment.

If you clear the check box, the **Emulation Hardware** subpane appears, initially showing the same values as the **Embedded Hardware** subpane. If you change any of these values, then generate code, the code will be able to execute in the environment specified by the **Emulation Hardware** subpane, but will behave as if it were executing in the environment specified by the **Embedded Hardware** subpane. See “Describing Emulation Hardware Characteristics” on page 9-55 for details.

If you have used the **Code Generation** pane to specify a **System target file**, and the target file specifies a default microprocessor and its hardware properties, the default and properties appear as initial values in the **Hardware Implementation** pane.

Options with only one possible value cannot be changed. Any option that has more than one possible value provides a list of legal values. If you specify any hardware properties manually, check carefully that their values are consistent with the system target file. Otherwise, the generated code may fail to compile or execute, or may execute but give incorrect results.

---

**Note Hardware Implementation** pane options do not control hardware or compiler behavior in any way. Their purpose is solely to describe hardware and compiler properties to MATLAB software, which uses the information to generate code for the platform that runs as efficiently as possible, and gives bit-true agreement for the results of integer and fixed-point operations in simulation, production code, and test code.

---

The rest of this section describes the options in the **Embedded Hardware** and **Emulation Hardware** subpanes. Subsequent sections describe considerations that apply only to one or the other subpane. For more about **Hardware Implementation** options, see “Hardware Implementation Pane”. To see an example of **Hardware Implementation** pane capabilities, run the `rtwdemo_targetsettings` example.

### **Describing the Device Vendor**

The **Device vendor** option gives the name of the device vendor. To set the option, select a vendor name from the **Device vendor** menu. Your selection of vendor will determine the available device values in the **Device type** list.

---

If the desired vendor name does not appear in the menu, select **Generic** and then use the **Device type** option to further specify the device.

---

### Note

- For complete lists of **Device vendor** and **Device type** values, see “Device vendor” and “Device type” in the Simulink reference documentation.
  - To add **Device vendor** and **Device type** values to the default set that is displayed on the **Hardware Implementation** pane, see “Registering Additional Device Vendor and Device Type Values” on page 9-47.
- 

### Describing the Device Type

The **Device type** option selects a hardware device among the supported devices listed for your **Device vendor** selection. To set the option, select a microprocessor name from the **Device type** menu. If the desired microprocessor does not appear in the menu, change the **Device vendor** to **Generic**.

If you specified **Device vendor** as **Generic**, examine the listed device descriptions and select the device type that matches your hardware. If no available device type matches, select **Custom**.

If you select a device type for which the target file specifies default hardware properties, the properties appear as initial values in the subpane. Options with only one possible value cannot be changed. Any option that has more than one possible value provides a list of legal values. Select values for your hardware. If the device type is **Custom**, more options can be set, and each option has a list of possible values.

### Registering Additional Device Vendor and Device Type Values

To add **Device vendor** and **Device type** values to the default set that is displayed on the **Hardware Implementation** pane, you can use a hardware device registration API provided by the Simulink Coder software.

To use this API, you create an `sl_customization.m` file, located in your MATLAB path, that invokes the `registerTargetInfo` function and fills in a hardware device registry entry with device information. The device information will be registered with Simulink software for each subsequent Simulink session. (To register your device information without restarting MATLAB, issue the MATLAB command `sl_refresh_customizations`.)

For example, the following `sl_customization.m` file adds device vendor `MyDevVendor` and device type `MyDevType` to the Simulink device lists.

```
function sl_customization(cm)
    cm.registerTargetInfo(@loc_register_device);
end
```

```
function thisDev = loc_register_device
    thisDev = RTW.HWDeviceRegistry;
    thisDev.Vendor = 'MyDevVendor';
    thisDev.Type = 'MyDevType';
    thisDev.Alias = {};
    thisDev.Platform = {'Prod', 'Target'};
    thisDev.setWordSizes([8 16 32 32 32]);
    thisDev.LargestAtomicInteger = 'Char';
    thisDev.LargestAtomicFloat = 'None';
    thisDev.Endianess = 'Unspecified';
    thisDev.IntDivRoundTo = 'Undefined';
    thisDev.ShiftRightIntArith = true;
    thisDev.setEnabled({'IntDivRoundTo'});
end
```

If you subsequently select the device in the **Hardware Implementation** pane, it is displayed as follows:

Embedded hardware (simulation and code generation)

Device vendor:  Device type:

Number of bits

char:	<input type="text" value="8"/>	short:	<input type="text" value="16"/>	int:	<input type="text" value="32"/>
long:	<input type="text" value="32"/>	float:	<input type="text" value="32"/>	double:	<input type="text" value="64"/>
native:	<input type="text" value="32"/>	pointer:	<input type="text" value="32"/>		

Largest atomic size

integer:

floating-point:

Byte ordering:  Signed integer division rounds to:

Shift right on a signed integer as arithmetic shift

To register multiple devices, you can specify an array of `RTW.HWDeviceRegistry` objects in your `sl_customization.m` file. For example,

```
function sl_customization(cm)
    cm.registerTargetInfo(@loc_register_device);
end

function thisDev = loc_register_device

    thisDev(1) = RTW.HWDeviceRegistry;
    thisDev(1).Vendor = 'MyDevVendor';
    thisDev(1).Type = 'MyDevType1';
    ...

    thisDev(4) = RTW.HWDeviceRegistry;
    thisDev(4).Vendor = 'MyDevVendor';
    thisDev(4).Type = 'MyDevType4';
    ...

end
```

The following table lists the `RTW.HWDeviceRegistry` properties that you can specify in the `registerTargetInfo` function call in your `sl_customization.m` file.

Property	Description
Vendor	String specifying the <b>Device vendor</b> value for your hardware device.
Type	String specifying the <b>Device type</b> value for your hardware device.
Alias	Cell array of strings specifying any aliases or legacy names that users might specify that should resolve to this device. Specify each alias or legacy name in the format 'Vendor->Type'. (Embedded Coder software provides the utility functions <code>RTW.isHWDeviceTypeEq</code> and <code>RTW.resolveHWDeviceType</code> for detecting and resolving alias values or legacy values when testing user-specified values for the target device type.)
Platform	Cell array of enumerated string values specifying whether this device should be listed in the <b>Embedded hardware</b> subpane ( <code>{'Prod'}</code> ), the <b>Emulation hardware</b> subpane ( <code>{'Target'}</code> ), or both ( <code>{'Prod', 'Target'}</code> ).
setWordSizes	Array of integer sizes to associate with the <b>Number of bits</b> parameters <b>char</b> , <b>short</b> , <b>int</b> , <b>long</b> , and <b>native word size</b> , respectively.
LargestAtomicInteger	String specifying an enumerated value for the <b>Largest atomic size: integer</b> parameter: 'Char', 'Short', 'Int', or 'Long'.
LargestAtomicFloat	String specifying an enumerated value for the <b>Largest atomic size: floating-point</b> parameter: 'Float', 'Double', or 'None'.
Endianess	String specifying an enumerated value for the <b>Byte ordering</b> parameter: 'Unspecified', 'Little' for little Endian, or 'Big' for big Endian.
IntDivRoundTo	String specifying an enumerated value for the <b>Signed integer division rounds to</b> parameter: 'Zero', 'Floor', or 'Undefined'.



Property	Description
ShiftRightIntArith	Boolean value specifying whether your compiler implements a signed integer right shift as an arithmetic right shift ( <code>true</code> ) or not ( <code>false</code> ).
setEnabled	Cell array of strings specifying which device properties should be enabled (modifiable) in the <b>Hardware Implementation</b> pane when this device type is selected. In addition to the 'Endianess', 'IntDivRoundTo', and 'ShiftRightIntArith' properties listed above, you can enable individual <b>Number of bits</b> parameters using the property names 'BitPerChar', 'BitPerShort', 'BitPerInt', 'BitPerLong', and 'NativeWordSize'.

## Describing the Number of Bits

The **Number of bits** options describe the **native word size** of the microprocessor, and the bit lengths of **char**, **short**, **int**, and **long** data. For code generation to succeed:

- The bit lengths must be such that **char** <= **short** <= **int** <= **long**.
- Bit lengths must be multiples of 8, with a maximum of 32.
- The bit length for **long** data must not be less than 32.

Simulink Coder integer type names are defined in the file `rtwtypes.h`. The values that you provide must be consistent with the word sizes as defined in the compiler's `limits.h` header file. The following table lists the standard Simulink Coder integer type names and maps them to the corresponding Simulink names.

Simulink Coder Integer Type	Simulink Integer Type
<code>boolean_T</code>	<code>boolean</code>
<code>int8_T</code>	<code>int8</code>
<code>uint8_T</code>	<code>uint8</code>

Simulink Coder Integer Type	Simulink Integer Type
int16_T	int16
uint16_T	uint16
int32_T	int32
uint32_T	uint32

If no ANSI C type with a matching word size is available, but a larger ANSI C type is available, the Simulink Coder code generator uses the larger type for `int8_T`, `uint8_T`, `int16_T`, `uint16_T`, `int32_T`, and `uint32_T`.

An application can use integer data of any length from 1 (unsigned) or 2 (signed) bits up to 32 bits. If the integer length matches the length of an available type, the Simulink Coder code generator uses that type. If no matching type is available, the code generator uses the smallest available type that can hold the data, generating code that never uses unnecessary higher-order bits. For example, on a target that provided 8-bit, 16-bit, and 32-bit integers, a signal specified as 24 bits would be implemented as an `int32_T` or `uint32_T`.

Code that uses emulated integer data is not maximally efficient, but can be useful during application development for emulating integer lengths that are available only on production hardware. The use of emulation does not affect the results of execution.

### Describing the Byte Ordering

The **Byte ordering** option specifies whether the target hardware uses **Big Endian** (most significant byte first) or **Little Endian** (least significant byte first) byte ordering. If left as **Unspecified**, the Simulink Coder software generates code that determines the endianness of the target; this is the least efficient option.

### Describing Quotient Rounding for Signed Integer Division

ANSI C does not completely define the rounding technique to be used when dividing one signed integer by another, so the behavior is implementation-dependent. If both integers are positive, or both are negative,

the quotient must round down. If either integer is positive and the other is negative, the quotient can round up or down.

The **Signed integer division rounds to** parameter tells the Simulink Coder code generator how the compiler rounds the result of signed integer division. Providing this information does not affect the operation of the compiler, it only describes that behavior to the code generator, which uses the information to optimize code generated for signed integer division. The parameter options are:

- **Zero** — If the quotient is between two integers, the compiler chooses the integer that is closer to zero as the result.
- **Floor** — If the quotient is between two integers, the compiler chooses the integer that is closer to negative infinity.
- **Undefined** — Choose this option if neither **Zero** nor **Floor** describes the compiler's behavior, or if that behavior is unknown.

The following table illustrates the compiler behavior that corresponds to each of these three options:

<b>N</b>	<b>D</b>	<b>Ideal N/D</b>	<b>Zero</b>	<b>Floor</b>	<b>Undefined</b>
33	4	8.25	8	8	8
-33	4	-8.25	-8	-9	-8 or -9
33	-4	-8.25	-8	-9	-8 or -9
-33	-4	8.25	8	8	8 or 9

---

**Note** Select **Undefined** only as a last resort. When the code generator does not know the signed integer division rounding behavior of the compiler, it generates extra code.

---

The compiler's implementation for signed integer division rounding can be obtained from the compiler documentation, or by experiment if no documentation is available.

## Describing Arithmetic Right Shifts on Signed Integers

ANSI C does not define the behavior of right shifts on negative integers, so the behavior is implementation-dependent. The **Shift right on a signed integer as arithmetic shift** parameter tells the Simulink Coder code generator how the compiler implements right shifts on negative integers. Providing this information does not affect the operation of the compiler, it only describes that behavior to the code generator, which uses the information to optimize the code generated for arithmetic right shifts.

Select the option if the C compiler implements a signed integer right shift as an arithmetic right shift, and clear the option otherwise. An arithmetic right shift fills bits vacated by the right shift with the value of the most significant bit, which indicates the sign of the number in twos complement notation. The option is selected by default. If your compiler handles right shifts as arithmetic shifts, this is the preferred setting.

- When the option is selected, the Simulink Coder software generates simple efficient code whenever the Simulink model performs arithmetic shifts on signed integers.
- When the option is cleared, the Simulink Coder software generates fully portable but less efficient code to implement right arithmetic shifts.

The compiler's implementation for arithmetic right shifts can be obtained from the compiler documentation, or by experiment if no documentation is available.

## Describing Embedded Hardware Characteristics

“Describing the Emulation and Embedded Targets” on page 9-45 documents the options available on the **Hardware Implementation** subpanes. This section describes considerations that apply only to the **Embedded Hardware** subpane. When you use this subpane, keep the following in mind:

- Code generation targets can have word sizes and other hardware characteristics that differ from the MATLAB host. Furthermore, code can be prototyped on hardware that is different from either the deployment target or the MATLAB host. The Simulink Coder code generator takes these differences into account when generating code.

- The Simulink product uses some of the information in the **Embedded Hardware** subpane to get the same results from simulation without code generation as executing generated code, including detecting error conditions that could arise on the target hardware, such as hardware overflow.
- The Simulink Coder software generates code that produces bit-true agreement with Simulink results for integer and fixed-point operations. Generated code that emulates unavailable data lengths runs less efficiently than it would without emulation, but the emulation does not affect bit-true agreement with Simulink for integer and fixed-point results.
- If you change targets at any point during application development, reconfigure the hardware implementation parameters for the new target before generating or regenerating code. Bit-true agreement for the results of integer and fixed-point operations in simulation, production code, and test code might not occur when code executes on hardware for which it was not generated.
- Use the **Integer rounding mode** parameter on your model's blocks to simulate the rounding behavior of the C compiler that you intend to use to compile code generated from the model. This setting appears on the **Signal Attributes** pane of the parameter dialog boxes of blocks that can perform signed integer arithmetic, such as the Product and n-D Lookup Table blocks.
- For most blocks, the value of **Integer rounding mode** completely defines rounding behavior. For blocks that support fixed-point data and the Simplest rounding mode, the value of **Signed integer division rounds to** also affects rounding. For details, see "Rounding".
- When models contain Model blocks, all models that they reference must be configured to use identical hardware settings.

## Describing Emulation Hardware Characteristics

"Describing the Emulation and Embedded Targets" on page 9-45 documents the options available on the **Hardware Implementation** subpanes. This section describes considerations that apply only to the **Emulation Hardware** subpane.

---

**Note** (If the **Emulation Hardware** subpane contains a button labeled **Configure current execution hardware device**, see “Updating from Earlier Versions” on page 9-57, then continue from this point.)

---

The default assumption is that the embedded target and emulation target are the same, so the **Emulation Hardware** subpane by default does not need to specify anything and contains only a selected check box labeled **None**. Code generated under this configuration will be suitable for production use, or for testing in an environment identical to the production environment.

To generate code that runs on an emulation target for test purposes, but behaves as if it were running on an embedded target in a production application, you must specify the properties of both targets in the **Hardware Implementation** pane. The **Embedded Hardware** subpane specifies embedded target hardware properties, as described previously. To specify emulation target properties:

- 1 Clear the **None** option in the **Emulation Hardware** subpane.

Embedded hardware (simulation and code generation)

Device vendor:  Device type:

Number of bits

char:	<input type="text" value="8"/>	short:	<input type="text" value="16"/>	int:	<input type="text" value="32"/>
long:	<input type="text" value="32"/>	float:	<input type="text" value="32"/>	double:	<input type="text" value="64"/>
native:	<input type="text" value="32"/>	pointer:	<input type="text" value="32"/>		

Largest atomic size

integer:

floating-point:

Byte ordering:  Signed integer division rounds to:

Shift right on a signed integer as arithmetic shift

- 2 In the **Emulation Hardware** subpane, specify the properties of the emulation target, using the instructions in “Describing the Emulation and Embedded Targets” on page 9-45

If you have used the **Code Generation** pane to specify a **System target file**, and the target file specifies a default microprocessor and its hardware properties, the default and properties appear as initial values in both subpanes of the **Hardware Implementation** pane.

Options with only one possible value cannot be changed. Any option that has more than one possible value provides a list of legal values. If you specify any hardware properties manually, check carefully that their values are consistent with the system target file. Otherwise, the generated code may fail to compile or execute, or may execute but give incorrect results.

If you do not display the **Emulation Hardware** subpane, the Simulink and Simulink Coder software defaults every **Emulation Hardware** option to have the same value as the corresponding **Embedded Hardware** option. If you hide the **Emulation Hardware** subpane after setting its values, the values that you specified will be lost. The underlying configuration parameters immediately revert to the values that they had when you exposed the subpane, and these values, rather than the values that you specified, will appear if you re-expose the subpane.

## Updating from Earlier Versions

If your model was created before Release 14 and has not been updated, by default the **Hardware Implementation** pane initially looks like this:

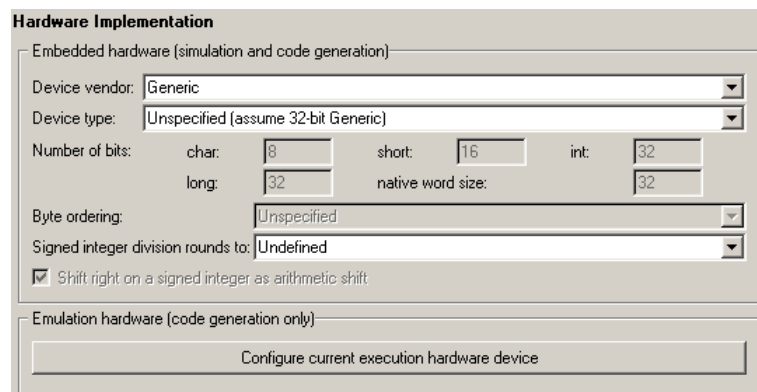

Click **Configure current execution hardware device**. The **Configure current execution hardware device** button disappears. The subpane then appears as shown in the first figure in this section. Save your model at this point to avoid redoing **Configure current execution hardware device** next time you access the **Hardware Implementation** pane.

## Specifying Target Interfaces

Use the **Interface** pane to control which math library is used at run time, whether to include one of three APIs in generated code, and certain other interface options.

To...	Select or Enter...
Specify the target-specific math library to use when generating code	<p>Select C89/C90 (ANSI), C99 (ISO), GNU99 (GNU), or C++ (ISO) for <b>Code replacement library</b>. (Additional values may be listed for licensed target products, for Embedded Targets and Desktop Targets, or if you have created and registered code replacement libraries with the Embedded Coder product.)</p> <p>Selecting C89/C90 (ANSI) provides the ANSI<sup>10</sup> C set of library functions. For example, selecting C89/C90 (ANSI) would result in generated code that calls <code>sin()</code> whether the input argument is double precision or single precision. However, if you select C99 (ISO), the call instead is to the function <code>sinf()</code>, which is single precision. If your compiler supports the ISO<sup>11</sup> C math extensions, selecting the ISO C library can result in more efficient code.</p> <p>For more information about code replacement libraries, see “Selecting and Viewing Code Replacement Libraries” on page 9-61.</p>
Direct where the Simulink Coder code generator should place fixed-point and other utility code	<p>Select Auto or Shared location for <b>Shared code placement</b>. The shared location directs code for utilities to be placed within the <code>slprj</code> folder in your working folder, which is used for building model reference targets. If you select Auto,</p> <ul style="list-style-type: none"> <li>• When the model contains Model blocks, places utility code within the <code>slprj/target/_sharedutils</code> folder.</li> <li>• When the model does not contain Model blocks, places utility code in the build folder (generally, in <code>model.c</code> or <code>model.cpp</code>).</li> </ul>

10. ANSI® is a registered trademark of the American National Standards Institute, Inc.

11. ISO® is a registered trademark of the International Organization for Standardization.



To...	Select or Enter...
Specify a string to be added to the variable names used when logging data to MAT-files, to distinguish logging data from Simulink Coder and Simulink applications	Enter a prefix or suffix, such as <code>rt_</code> or <code>_rt</code> , for <b>MAT-file variable name modifier</b> . The Simulink Coder code generator prefixes or appends the string to the variable names for system outputs, states, and simulation time specified in the <b>Data Import/Export</b> pane. See “Logging” on page 15-105 for information on MAT-file data logging.
Specify an API to be included in generated code	Select <b>C API</b> , <b>External mode</b> , or <b>ASAP2</b> for <b>Interface</b> . When you select <b>C API</b> or <b>External mode</b> , other options appear. <b>C API</b> and <b>External mode</b> are mutually exclusive. However, this is not the case for <b>C API</b> and <b>ASAP2</b> . For more information on working with these interfaces, see “Data Interchange Using the C API” on page 15-137, “Host/Target Communication” on page 15-50, and “ASAP2 Data Measurement and Calibration” on page 15-174.

---

**Note** Before setting **Code replacement library**, verify that your compiler supports the library you want to use. If you select a parameter value that your compiler does not support, compiler errors can occur. For example, if you select **C99 (ISO)** and your compiler does not support the ISO C math extensions, compile-time errors likely will occur.

---

When the Embedded Coder product is installed on your system, the **Code Generation > Interface** pane expands to include several additional options. For descriptions of **Code Generation > Interface** pane parameters, see “Code Generation Pane: Interface”. For a summary of option dependencies, see “Interface Dependencies” on page 9-59.

### Interface Dependencies

Several parameters available on the Interface pane have dependencies on settings of other parameters. The following table summarizes the dependencies.

<b>Parameter</b>	<b>Dependencies?</b>	<b>Dependency Details</b>
<b>Code replacement library</b>	No	
<b>Shared code placement</b>	No	
<b>Support: floating-point numbers</b> (ERT targets only)	No	
<b>Support: non-finite numbers</b>	Yes (ERT targets) No (GRT targets)	For ERT targets, enabled by <b>Support floating-point numbers</b>
<b>Support: complex numbers</b> (ERT targets only)	No	
<b>Support: absolute time</b> (ERT targets only)	No	
<b>Support: continuous time</b> (ERT targets only)	No	
<b>Support: non-inlined S-functions</b> (ERT targets only)	Yes	Requires that you enable <b>Support floating-point numbers</b> and <b>Support non-finite numbers</b>
<b>Classic call interface</b>	Yes (ERT targets) No (GRT targets)	For ERT targets, requires that you enable <b>Support floating-point numbers</b> and disable <b>Single output/update function</b>
<b>Single output/update function</b> (ERT targets only)	Yes	Disable for <b>Classic call interface</b>
<b>Terminate function required</b> (ERT targets only)	Yes	
<b>Generate reusable code</b> (ERT targets only)	Yes	
<b>Reusable code error diagnostic</b> (ERT targets only)	Yes	Enabled by <b>Generate reusable code</b>

<b>Parameter</b>	<b>Dependencies?</b>	<b>Dependency Details</b>
<b>Pass root-level I/O as (ERT targets only)</b>	Yes	Enabled by <b>Generate reusable code</b>
<b>MAT-file logging</b>	Yes	For GRT targets, requires that you enable <b>Support non-finite numbers</b> ; for ERT targets, requires that you enable <b>Support floating-point numbers</b> , <b>Support non-finite numbers</b> , and <b>Terminate function required</b>
<b>MAT-file file variable name modifier</b>	Yes	Enabled by <b>MAT-file logging</b>
<b>Suppress error status in real-time model data structure (ERT targets only)</b>	No	
<b>Interface</b>	No	
<b>Generate C API for: signals</b>	Yes	Set <b>Interface</b> to C API
<b>Generate C API for: parameters</b>	Yes	Set <b>Interface</b> to C API
<b>Generate C API for: states</b>	Yes	Set <b>Interface</b> to C API
<b>Transport layer</b>	Yes	Set <b>Interface</b> to External mode
<b>MEX-file arguments</b>	Yes	Set <b>Interface</b> to External mode
<b>Static memory allocation</b>	Yes	Set <b>Interface</b> to External mode
<b>Static memory buffer size</b>	Yes	Enable <b>Static memory allocation</b>

## Selecting and Viewing Code Replacement Libraries

- “Selecting a Target-Specific Math Library for Your Model” on page 9-62
- “Code Replacement Table Overview” on page 9-63
- “Using the Code Replacement Viewer” on page 9-65

## Selecting a Target-Specific Math Library for Your Model

A *code replacement library* (CRL) is a set of one or more code replacement tables that define the target-specific implementations of math functions and operators to be used in generating code for your Simulink model. The Simulink Coder product provides default CRLs, which you can select from the **Code replacement library** drop-down list on the **Code Generation > Interface** pane of the Configuration Parameters dialog box.

CRL	Description	Contains tables...
C89/C90 (ANSI)	Generates calls to the ISO/IEC 9899:1990 C standard math library for floating-point functions.	ansi_tfl_table_tmw.mat
C99 (ISO)	Generates calls to the ISO/IEC 9899:1999 C standard math library.	iso_tfl_table_tmw.mat ansi_tfl_table_tmw.mat
GNU99 (GNU)	Generates calls to the Free Software Foundation's GNU gcc math library, which provides C99 extensions as defined by compiler option <code>-std=gnu99</code> .	gnu_tfl_table_tmw.mat iso_tfl_table_tmw.mat ansi_tfl_table_tmw.mat
C++ (ISO)	Generates calls to the ISO/IEC 14882:2003 C++ standard math library.	iso_cpp_tfl_table_tmw.mat private_iso_cpp_tfl_table_tmw.mat iso_tfl_table_tmw.mat ansi_tfl_table_tmw.mat

CRL tables provide the basis for replacing default math functions and operators in your model code with target-specific code. If you select a library and then hover over the selected library with the cursor, a tool tip is displayed that describes the CRL and lists the code replacement tables it contains. Tables are listed in the order in which they are searched for a function or operator match.

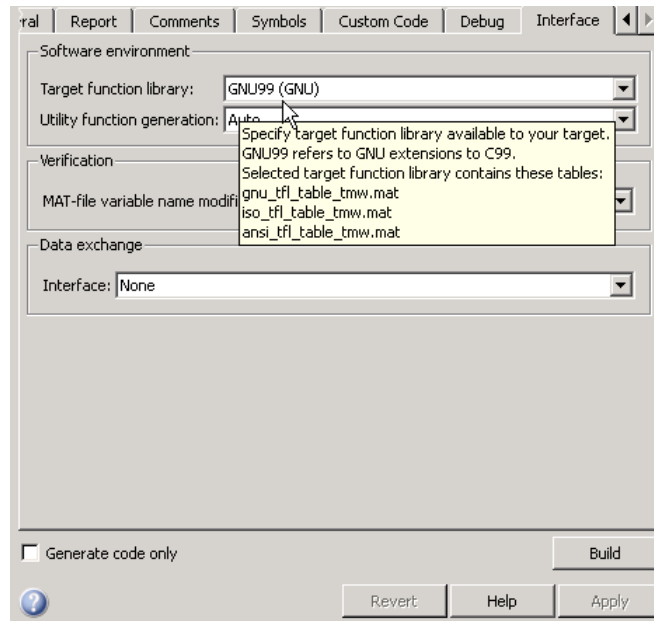

The Simulink Coder product allows you to view the content of CRL code replacement tables using the Code Replacement Viewer, as described in “Using the Code Replacement Viewer” on page 9-65. If you are licensed to use the Embedded Coder product, you additionally can create and register the code replacement tables that make up a CRL.

## Code Replacement Table Overview

Each CRL code replacement table contains one or more table entries, with each table entry representing a potential replacement for a single math function or an operator. Each table entry provides a mapping between a *conceptual view* of the function or operator (similar to the Simulink block view of the function or operator) and a *target-specific implementation* of that function or operator.

The conceptual view of a function or operator is represented in a CRL table entry by the following elements, which identify the function or operator entry to the code generation process:

- A function or operator key (a function name such as 'cos' or an operator ID string such as 'RTW\_OP\_ADD')
- A set of conceptual arguments that observe Simulink naming ('y1', 'u1', 'u2', ...), along with their I/O types (output or input) and data types
- Other attributes, such as fixed-point saturation and rounding characteristics for operators, to identify the function or operator to the code generation process as exactly as required for matching purposes

The target-specific implementation of a function or operator is represented in a CRL table entry by the following elements:

- The name of an implementation function (such as 'cos\_dbl' or 'u8\_add\_u8\_u8')
- A set of implementation arguments, along with their I/O types (output or input) and data types
- Parameters providing the build information for the implementation function, including header file and source file names and paths

Additionally, a CRL table entry includes a priority value (0-100, with 0 as the highest priority), which defines the entry's priority relative to other entries in the table.

During code generation for your model, when the code generation process encounters a call site for a math function or operator, it creates and partially populates a CRL entry object, for the purpose of querying the CRL for a replacement function. The information provided for the CRL query includes the function or operator key and the conceptual argument list. The CRL entry object is then passed to the CRL. If the CRL contains a matching table entry, a fully-populated CRL entry, including the implementation function name, argument list, and build information, is returned to the call site and used to generate code.

Within the CRL that is selected for your model, the tables that comprise the CRL are searched in the order in which they are listed (in the left or right pane of the Code Replacement Viewer or in the CRL's **Code replacement library** tool tip). Within each table, if multiple matches are found for a CRL entry object, priority level determines the match that is returned. A

higher-priority (lower-numbered) entry will be used over a similar entry with a lower priority (higher number).

## Using the Code Replacement Viewer

The Code Replacement Viewer allows you to examine the content of CRL code replacement tables. (For an overview of code replacement tables and the information they contain, see the preceding section.) To launch the viewer with all currently registered CRLs displayed, issue the following MATLAB command:

```
>> RTW.viewTf1
```

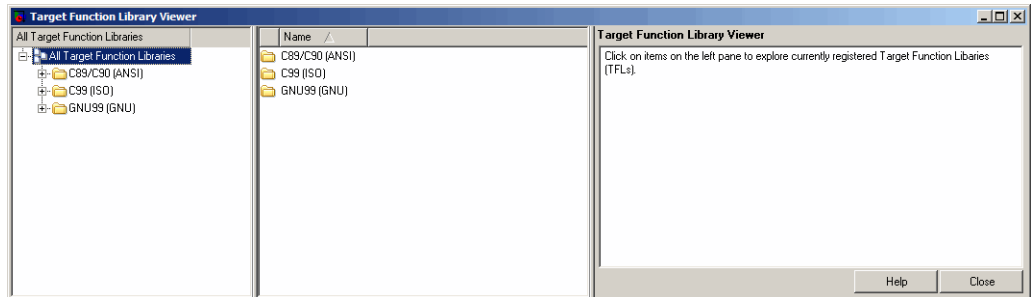

Select the name of a CRL in the left pane, and the viewer displays information about the CRL in the right pane. For example, the tables that make up the CRL are listed in priority order. In the following display, the GNU CRL has been selected.

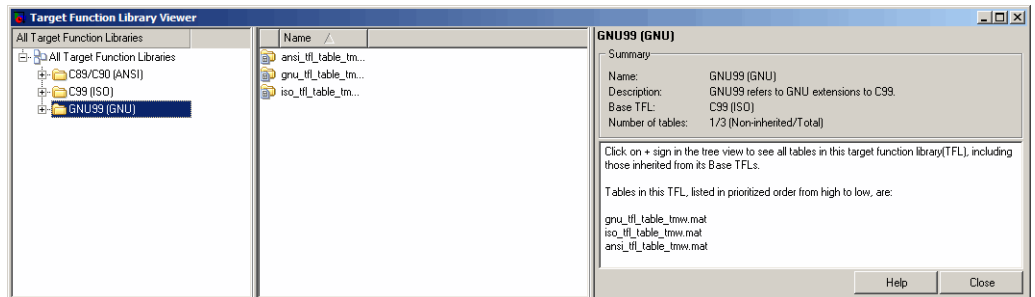

Click the plus sign (+) next to a CRL name in the left pane to expand its list of tables, and select a table from the list. The viewer displays the function

and operator entries in the selected table in the middle pane, along with abbreviated table entry information for each entry. In the following display, the ANSI table has been selected.

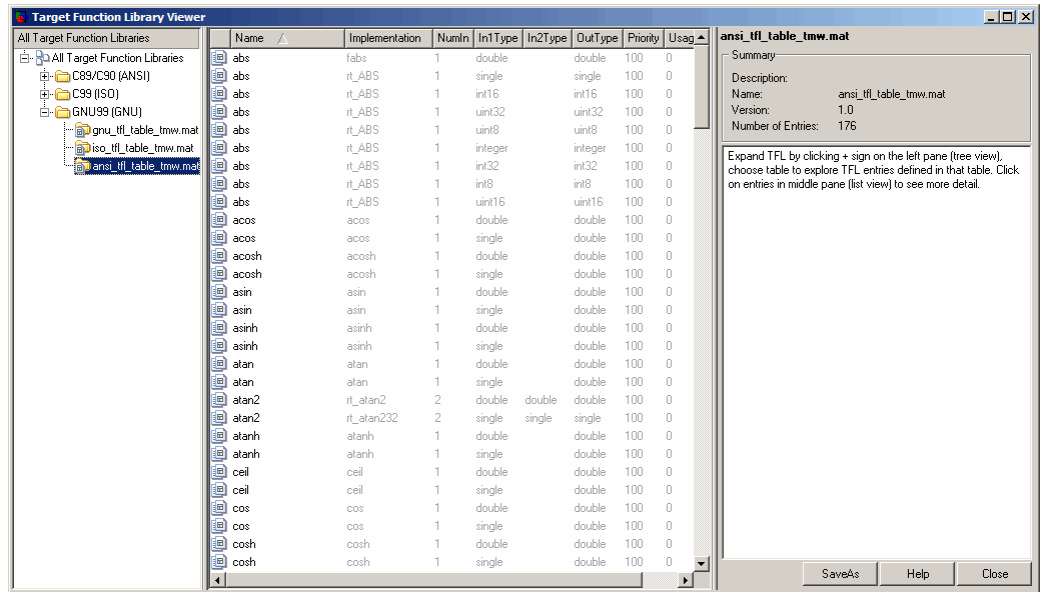

The following fields appear in the abbreviated table entry information provided in the middle pane:

Field	Description
Name	Name of the function or ID of the operator to be replaced (for example, cos or RTW_OP_ADD).
Implementation	Name of the implementation function, which can match or differ from Name.
NumIn	Number of input arguments.
In1Type	Data type of the first conceptual input argument.
In2Type	Data type of the second conceptual input argument.
OutType	Data type of the conceptual output argument.



Field	Description
Priority	The entry's search priority, 0-100, relative to other entries of the same name and conceptual argument list within this table. Highest priority is 0, and lowest priority is 100. The default is 100. If the table provides two implementations for a function or operator, the implementation with the higher priority will shadow the one with the lower priority.
UsageCount	Not used.

Select a function or operator entry in the middle pane. The viewer displays detailed information from the table entry in the right pane. In the following display, the second entry for the `cos` function has been selected.

The screenshot shows the Target Function Library Viewer interface. The left pane displays a tree view of function libraries, including C99/C90 (ANSI), C99 (ISO), and GNU99 (GNU). The middle pane shows a list of functions with columns: Name, Implementation, NumIn, In1Type, In2Type, OutType, Priority, and Usage. The 'cos' function is selected, showing its implementation as 'cos' with 1 input of type 'single' and an output of type 'double' with a priority of 100 and usage count of 0.

The right pane displays detailed information for the selected 'cos' function:

- General Information**
- Summary**
- Description:**
- Key:** cos with 1 input(s)
- Implementation:** cos () with 1 input(s)
- Implementation type:** FCN\_IMPL\_FUNC
- Saturation mode:** RTW\_SATURATE\_UNSPECIFIED
- Rounding mode:** RTW\_ROUND\_UNSPECIFIED
- GenCallback file:**
- Implementation header:** <math.h>
- Implementation source:**
- Priority:** 100
- Total Usage Count:** 0

The **Entry argument(s)** section shows:

Conceptual argument(s):		
Name	I/O type	Data type
y1	RTW_IO_OUTPUT	single
u1	RTW_IO_INPUT	single

The **Implementation:** section shows:

Name	I/O type	Data type
y1	RTW_IO_OUTPUT	double
u1	RTW_IO_INPUT	single

The following fields appear in the detailed table entry information provided in the right pane.

Field	Description
Description	Text description of the table entry (can be empty).
Key	Name of the function or ID of the operator to be replaced (for example, <code>cos</code> or <code>RTW_OP_ADD</code> ), and the number of conceptual input arguments.
Implementation	Name of the implementation function, and the number of implementation input arguments.
Implementation type	Type of implementation: <code>FCN_IMPL_FUNCT</code> for function or <code>FCN_IMPL_MACRO</code> for macro.
Saturation mode	Saturation mode supported by the implementation function for an operator replacement: <code>RTW_SATURATE_ON_OVERFLOW</code> , <code>RTW_WRAP_ON_OVERFLOW</code> , or <code>RTW_SATURATE_UNSPECIFIED</code> .
Rounding mode	Rounding mode supported by the implementation function for an operator replacement: <code>RTW_ROUND_FLOOR</code> , <code>RTW_ROUND_CEILING</code> , <code>RTW_ROUND_ZERO</code> , <code>RTW_ROUND_NEAREST</code> , <code>RTW_ROUND_NEAREST_ML</code> , <code>RTW_ROUND_SIMPLEST</code> , <code>RTW_ROUND_CONV</code> , or <code>RTW_ROUND_UNSPECIFIED</code> .
GenCallback file	Not used.
Implementation header	Name of the header file that declares the implementation function.
Implementation source	Name of the implementation source file.
Priority	The entry's search priority, 0-100, relative to other entries of the same name and conceptual argument list within this table. Highest priority is 0, and lowest priority is 100. The default is 100. If the table provides two implementations for a function or operator, the implementation with the higher priority will shadow the one with the lower priority.

Field	Description
Total Usage Count	Not used.
Conceptual argument(s)	Name, I/O type (RTW_IO_OUTPUT or RTW_IO_INPUT), and data type for each conceptual argument.
Implementation	Name, I/O type (RTW_IO_OUTPUT or RTW_IO_INPUT), and data type for each implementation argument.

If you select an operator entry, an additional tab containing fixed-point setting information is displayed in the right pane. For example:

The screenshot shows a dialog box titled "RTW\_OP\_ADD" with two tabs: "General Information" and "Fixed-point Settings". The "Fixed-point Settings" tab is active. It contains a "Summary" section with the following values:

- Slopes must be the same: no
- Must have zero net bias: no
- Relative scaling factor F: 1
- Relative scaling factor E: 0

Below the summary is a section for "Entry argument(s)" which contains two tables:

**Conceptual argument(s):**

Name	I/O type	Data type
y1	RTW_IO_OUTPUT	int16
u1	RTW_IO_INPUT	int16
u2	RTW_IO_INPUT	int16

**Implementation:**

Name	I/O type	Data type
y1	RTW_IO_OUTPUT	int16
u1	RTW_IO_INPUT	int16
u2	RTW_IO_INPUT	int16

At the bottom of the dialog are "Help" and "Close" buttons.

The following fields appear in the fixed-point setting information provided in the right pane:

Field	Description
Slopes must be the same	Indicates whether CRL replacement request processing must check that the slopes on all arguments (input and output) are equal. Used with fixed-point addition and subtraction replacement to disregard specific slope and bias values and map relative slope and bias values to a replacement function.
Must have zero net bias	Indicates whether CRL replacement request processing must check that the net bias on all arguments is zero. Used with fixed-point addition and subtraction replacement to disregard specific slope and bias values and map relative slope and bias values to a replacement function.
Relative scaling factor F	Slope adjustment factor (F) part of the relative scaling factor, $F2^E$ , for relative scaling CRL entries. Used with fixed-point multiplication and division replacement to map a range of slope and bias values to a replacement function.
Relative scaling factor E	Fixed exponent (E) part of the relative scaling factor, $F2^E$ , for relative scaling CRL entries. Used with fixed-point multiplication and division replacement to map a range of slope and bias values to a replacement function.

## Select the Target Language

Use the **Language** menu in the **Target selection** section of the **Code Generation** pane to select the target language for the code generated by the Simulink Coder code generator. You can select C or C++. The Simulink Coder software generates `.c` or `.cpp` files, depending on your selection, and places the files in your build folder.

---

**Note** If you select C++, you might need to configure the Simulink Coder software to use a compiler before you build a system. For details, see “Choose and Configure a Compiler” on page 15-2.

---

## Code Appearance

In this section...
“Configure Code Comments” on page 9-72
“Configure Generated Identifiers” on page 9-73

### Configure Code Comments

Configure how the code generator inserts comments into generated code, by modifying parameters on the Comments pane.

---

**Note** Comments can include international (non-US-ASCII) characters encountered during code generation when found in Simulink block names and block descriptions, user comments on Stateflow diagrams, Stateflow object descriptions, custom TLC files, and code generation template files.

---

To...	Select...
Include comments in generated code	<b>Include comments.</b> Selecting this parameter allows you to select one or more comment types to be placed in the code.
Include comments for blocks that were eliminated as the result of optimizations (such as parameter inlining)	<b>Show eliminated blocks.</b>

To...	Select...
Automatically insert comments that describe a block's code before the code in the generated file	<b>Simulink block / Stateflow object comments.</b>
Include comments for parameter variable names and names of source blocks in the model parameter structure declaration in <i>model_prm.h</i>	<b>Verbose comments for SimulinkGlobal storage class.</b> If you do not select this parameter, parameter comments are generated if less than 1000 parameters are declared. This reduces the size of the generated file for models with a large number of parameters. When you select the parameter, parameter comments are generated regardless of the number of parameters.

For descriptions of Comments pane parameters, see “Code Generation Pane: Comments” in the Simulink Coder reference documentation.

## Configure Generated Identifiers

- “Reserved Keywords” on page 9-74
- “Construction of Symbols” on page 9-78

Configure how the code generator uses symbols to name identifiers and objects by setting parameters on the **Symbols** pane.

Two options are available for GRT targets: **Maximum identifier length** and **Reserved names**. These are the only symbols options for GRT targets.

The **Maximum identifier length** field allows you to limit the number of characters in function, type definition, and variable names. The default is 31 characters. This is also the minimum length you can specify; the maximum is 256 characters. Consider increasing identifier length for models having a deep hierarchical structure, and when exercising some of the mnemonic identifier options described below.

Within a model containing Model blocks, no collisions of constituent model names can exist. When generating code from a model that uses model

referencing, the **Maximum identifier length** must be large enough to accommodate the root model name and the name mangling string (if any). A code generation error occurs if **Maximum identifier length** is too small.

When a name conflict occurs between a symbol within the scope of a higher level model and a symbol within the scope of a referenced model, the symbol from the referenced model is preserved. Name mangling is performed on the symbol from the higher level model.

The **Reserved names** field allows you to specify the set of keywords that the Simulink Coder code generation process should not use, facilitating code integration where functions and variables from external environments are unknown in the Simulink model. For a list of rules for specifying reserved names, see “Reserved names” in the Simulink Coder reference documentation.

If your model contains MATLAB Function or Stateflow blocks, the code generation process can use the reserved names specified for those blocks if you select **Use the same reserved names as Simulation Target**.

If the Embedded Coder product is installed on your system, the **Symbols** pane expands to include options for controlling identifier formats, mangle length, scalar inlined parameters, and Simulink data object naming rules. For details, see “Customize Generated Identifiers” in the Embedded Coder documentation.

For descriptions of Symbols pane parameters, see “Code Generation Pane: Symbols”.

## **Reserved Keywords**

- “C Reserved Keywords” on page 9-75
- “C++ Reserved Keywords” on page 9-75
- “Reserved Keywords for Code Generation” on page 9-76
- “Simulink<sup>®</sup> Coder<sup>™</sup> Code Replacement Library Keywords” on page 9-76

Simulink Coder software reserves certain words for its own use as keywords of the generated code language. Simulink Coder keywords are reserved for use internal to Simulink Coder software and should not be used in Simulink



models as identifiers or function names. C reserved keywords should also not be used in Simulink models as identifiers or function names. If your model contains any reserved keywords, the code generation build does not complete and an error message is displayed. To address this error, modify your model to use identifiers or names that are not reserved.

If you are generating C++ code using the Simulink Coder software, your model must not contain both the “Reserved Keywords for Code Generation” on page 9-76 and the “C++ Reserved Keywords” on page 9-75.

---

**Note** You can register additional reserved identifiers in the Simulink environment. For more information, see “Reserved names” in the Simulink Coder reference documentation.

---

### C Reserved Keywords.

auto	double	int	struct
break	else	long	switch
case	enum	register	typedef
char	extern	return	union
const	float	short	unsigned
continue	for	signed	void
default	goto	sizeof	volatile
do	if	static	while

### C++ Reserved Keywords.

catch	friend	protected	try
class	inline	public	typeid
const_cast	mutable	reinterpret_cast	typename
delete	namespace	static_cast	using
dynamic_cast	new	template	virtual

explicit	operator	this	wchar_t
export	private	throw	

**Reserved Keywords for Code Generation.**

abs	fortran	localZCE	rtNaN
asm	HAVESTDIO	localZCSV	SeedFileBuffer
bool	id_t	matrix	SeedFileBufferLen
boolean_T	int_T	MODEL	single
byte_T	int8_T	MT	TID01EQ
char_T	int16_T	NCSTATES	time_T
cint8_T	int32_T	NULL	true
cint16_T	int64_T	NUMST	TRUE
cint32_T	INTEGER_CODE	pointer_T	uint_T
creal_T	LINK_DATA_BUFFER_SIZE	PROFILING_ENABLED	uint8_T
creal32_T	LINK_DATA_STREAM	PROFILING_NUM_SAMPLES	uint16_T
creal64_T	localB	real_T	uint32_T
cuint8_T	localC	real32_T	uint64_T
cuint16_T	localDWork	real64_T	UNUSED_PARAMETER
cuint32_T	localP	RT	USE_RTMODEL
ERT	localX	RT_MALLOC	VCAST_FLUSH_DATA
false	localXdis	rtInf	vector
FALSE	localXdot	rtMinusInf	

**Simulink Coder Code Replacement Library Keywords.** The list of code replacement library (CRL) reserved keywords for your development environment varies depending on which CRLs currently are registered. Beyond the default ANSI, ISO, and GNU CRLs provided with Simulink Coder software, additional CRLs might be registered and available for use if you have installed other products that provide CRLs (for example, a target product), or if you have used Embedded Coder APIs to create and register custom CRLs.

To generate a list of reserved keywords for CRLs currently registered in your environment, use the following MATLAB function:

```
crl_ids = RTW.TargetRegistry.getInstance.getTf1ReservedIdentifiers()
```

This function returns an array of CRL keyword strings. Specifying the return argument is optional.

---

**Note** To list the CRLs currently registered in your environment, use the MATLAB command `RTW.viewTf1`.

---

To generate a list of reserved keywords for the CRL that you are using to generate code, call the function passing the name of the CRL as displayed in the **Code replacement library** menu on the **Code Generation > Interface** pane of the Configuration Parameters dialog box. For example,

```
crl_ids = RTW.TargetRegistry.getInstance.getTf1ReservedIdentifiers('GNU99 (GNU)')
```

Here is a partial example of the function output:

```
>> crl_ids = RTW.TargetRegistry.getInstance.getTf1ReservedIdentifiers('GNU99 (GNU)')

crl_ids =

    'exp10'
    'exp10f'
    'acosf'
    'acoshf'
    'asinf'
    'asinhf'
    'atanf'
    'atanhf'
    ...
    'rt_lu_cplx'
    'rt_lu_cplx_sgl'
    'rt_lu_real'
    'rt_lu_real_sgl'
    'rt_mod_boolean'
    'rt_rem_boolean'
```

```
'strcpy'  
'utAssert'
```

---

**Note** Some of the returned keyword strings appear with the suffix \$N, for example, 'rt\_atan2\$N'. \$N expands into the suffix \_snf only if nonfinite numbers are supported. For example, 'rt\_atan2\$N' represents 'rt\_atan2\_snf' if nonfinite numbers are supported and 'rt\_atan2' if nonfinite numbers are not supported. As a precaution, you should treat both forms of the keyword as reserved.

---

### Construction of Symbols

For GRT, GRT-malloc and RSim targets, the Simulink Coder code generator automatically constructs identifiers for variables and functions in the generated code. These symbols identify

- Signals and parameters that have Auto storage class
- Subsystem function names that are not user defined
- Stateflow names

The components of a generated symbol include

- The root model name, followed by
- The name of the generating object (signal, parameter, state, and so on), followed by
- A unique *name mangling* string

The name mangling string is conditionally generated to resolve potential conflicts with other generated symbols.

The length of generated symbols is limited by the **Maximum identifier length** parameter specified on the **Symbols** pane of the Configuration Parameters dialog box. When there is a potential name collision between two symbols, a name mangling string is generated. The string has the minimum number of characters required to avoid the collision. The other symbol components are then inserted. If **Maximum identifier length** is not large

enough to accommodate full expansions of the other components, they are truncated. To avoid this outcome, it is good practice to:

- Avoid name collisions. For example, avoid using default block names (for example, `Gain1`, `Gain2...`) when the model includes multiple blocks of the same type. Also, make subsystems atomic and reusable.
- Where possible, increase the **Maximum identifier length** parameter to accommodate the length of the symbols you expect to generate.

Model referencing might involve additional naming constraints. Within a model that uses referenced models, there can be no collisions between the names of the models. When you generate code from a model that includes referenced models, the **Maximum identifier length** parameter must be large enough to accommodate the root model name and the name mangling string (if needed). When a name conflict occurs between a symbol within the scope of a higher-level model and a symbol within the scope of a referenced model, the symbol from the referenced model is preserved. Name mangling is performed on the symbol from the higher-level model. For information, see “Configure Generated Identifiers” on page 9-73 and “Parameterize Model References”.

The Embedded Coder product provides additional flexibility over how symbols are constructed, by using a **Symbol format** field that controls the symbol formatting in much greater detail. See “Configure Symbols” in the Embedded Coder documentation for more information.

## Debug

Use parameters on the **Diagnostics** and **Code Generation > Debug** panes of the Configuration Parameter dialog box to configure a model such that generated code and the build process are optimized for debugging. You can set parameters that apply to the model compilation phase, the target language code generation phase, or both.

Parameters in the following table will be helpful if you are writing TLC code for customizing targets, integrating legacy code, or developing new blocks.

To...	Select...
Display progress information during code generation in the MATLAB Command Window	<b>Verbose build.</b> Compiler output also displays.
Prevent the build process from deleting the <i>model.rtw</i> file from the build folder at the end of the build	<b>Retain .rtw file.</b> This parameter is useful if you are modifying the target files, in which case you need to look at the <i>model.rtw</i> file.
Instruct the TLC profiler to analyze the performance of TLC code executed during code generation and generate a report	<b>Profile TLC.</b> The report is in HTML format and can be read in your Web browser.
Start the TLC debugger during code generation	<b>Start TLC debugger when generating code.</b> Alternatively, enter the argument <code>-dc</code> for the <b>System target file</b> parameter on the <b>Code Generation</b> pane. To start the debugger and run a debugger script, enter <code>-df filename</code> for <b>System target file</b> .

To...	Select...
<p>Generate a report containing statistics indicating how many times the Simulink Coder code generator reads each line of TLC code during code generation</p>	<p><b>Start TLC coverage when generating code.</b> Alternatively, enter the argument <code>-dg</code> for the <b>System Target File</b> parameter on the <b>Code Generation</b> pane.</p>
<p>Halt a build if any user-supplied TLC file contains an <code>%assert</code> directive that evaluates to <code>FALSE</code></p>	<p><b>Enable TLC assertion.</b> Alternatively, you can use MATLAB commands to control TLC assertion handling. To set the flag on or off, use the <code>set_param</code> command. The default is off.</p> <pre>set_param(model, 'TLCAssertion', 'on off')</pre> <p>To check the current setting, use <code>get_param</code>.</p> <pre>get_param(model, 'TLCAssertion')</pre>
<p>Detect loss of tunability</p>	<p><b>Diagnostics &gt; Data Validity &gt; Detect loss of tunability.</b> You can use this parameter to report loss of tunability when an expression is reduced to a numeric expression. This can occur if a tunable workspace variable is modified by Mask Initialization code, or is used in an arithmetic expression with unsupported operators or functions. Possible values are:</p> <ul style="list-style-type: none"> <li>• none — Loss of tunability can occur without notification.</li> <li>• warning — Loss of tunability generates a warning (default).</li> <li>• error — Loss of tunability generates an error.</li> </ul>

To...	Select...
	<p>For a list of supported operators and functions, see “Tunable Expression Limitations” on page 15-131</p>
<p>Enable model verification (assertion) blocks</p>	<p><b>Diagnostics &gt; Data Validity &gt; Model Verification block enabling</b> . Use this parameter to enable or disable model verification blocks such as Assert, Check Static Gap, and related range check blocks. The diagnostic has the same affect on generated code as it does on simulation behavior. For example, simulation and code generation ignore this parameter when model verification blocks are inside an S-function. Possible values are:</p> <ul style="list-style-type: none"> <li>• User local settings</li> <li>• Enable All</li> <li>• Disable All</li> </ul> <p>For Assertion blocks not disabled, generated code for a model includes one of the following statements, depending on the blocks input signal type (Boolean, real, or integer, respectively).</p> <pre>utAssert(input_signal); utAssert(input_signal != 0.0); utAssert(input_signal != 0);</pre> <p>By default, <code>utAssert</code> has no effect in generated code. For assertions to abort execution, you must enable them by specifying the following <code>make_rtw</code> command for <b>Code Generation &gt; Make command</b>:</p> <pre>make_rtw OPTS="-DDOASSERTS"</pre> <p>Use the following variant if you want triggered assertions to print the assertion statement instead of aborting execution:</p>



To...	Select...
	<pre data-bbox="660 352 1292 378">make_rtw OPTS="-DDOASSERTS -DPRINT_ASSERTS"</pre> <p data-bbox="660 421 1248 482">utAssert is defined as <code>#define utAssert(exp) assert(exp)</code>.</p> <p data-bbox="660 499 1307 690">To customize assertion behavior, provide your own definition of <code>utAssert</code> in a handwritten header file that overrides the default <code>utAssert.h</code>. For details on how to include a customized header file in generated code, see “Configure Model for External Code Integration” on page 14-33.</p> <p data-bbox="660 708 1273 864">When running a model in accelerator mode, the Simulink engine calls back to itself to execute assertion blocks instead of using generated code. Thus, user-defined callbacks are still called when assertions fail.</p>

For more information about the TLC debugging options, see “Debugging”. Also, consider using the Model Advisor as a tool for troubleshooting model builds.

For descriptions of Debug pane parameters, see “Code Generation Pane: Debug” in the Simulink Coder reference documentation.



# Source Code Generation

---

- “Initiate Code Generation” on page 10-2
- “Reload Generated Code” on page 10-3
- “Generated Source Files and File Dependencies” on page 10-4
- “Files and Folders Created by Build Process” on page 10-24
- “How Code Is Generated From a Model” on page 10-31
- “Code Generation of Matrices and Arrays” on page 10-33
- “Shared Utility Code” on page 10-37
- “Generating Code Using Simulink Coder™” on page 10-49

### Initiate Code Generation

You can generate code for your model with or without the compilation, linking, and other processing that occurs as part of a full model build. To generate code without initiating a full model build, select the **Generate code only** option on the **Code Generation** pane of the Configuration Parameters dialog box and click **Generate Code**. To initiate a full model build, clear the **Generate code only** option and click the **Build** button, or use any of the methods described in “Initiate the Build Process” on page 15-14.

## Reload Generated Code

You can reload the code generated for a model from the Model Explorer.

- 1 Click the **Code for *model*** node in the **Model Hierarchy** pane.
- 2 In the **Code** pane, click the **Refresh** link.

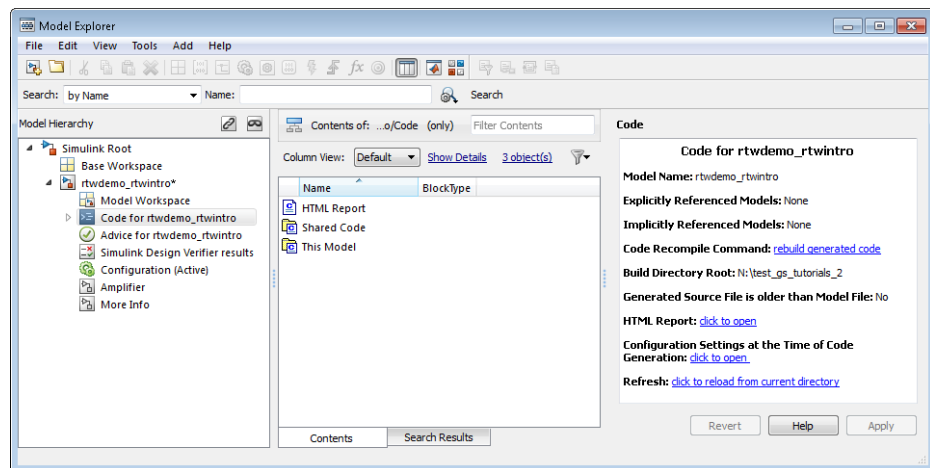

The Simulink Coder software reloads the code for the model from the build folder.

## Generated Source Files and File Dependencies

### In this section...

“About Generated Files and File Dependencies” on page 10-4

“Header Dependencies When Interfacing Legacy/Custom Code with Generated Code” on page 10-6

“Dependencies of the Generated Code” on page 10-16

“Specify Include Paths in Simulink® Coder™ Generated Source Files” on page 10-21

### About Generated Files and File Dependencies

The Simulink Coder software generates code into a set of source files that vary little among different targets. Not all possible files are generated for every model. Some files are created only when the model includes subsystems, calls external interfaces, or uses particular types of data. The Simulink Coder code generator handles most of the code formatting decisions (such as identifier construction and code packaging) in consistent ways.

The source and make files created during the Simulink Coder build process are generated into your build folder, which is created or reused in your current folder. Some files are unconditionally generated, while the existence of others depend on target settings and options (for example, support files for C API or external mode). See “Files and Folders Created by Build Process” on page 10-24 for descriptions of the generated files.

---

**Note** The file packaging of Embedded Coder targets differs slightly from the file packaging described below. See “Generate Code Modules” in the Embedded Coder documentation for more information.

---

Generated source file dependencies are depicted in the next figure. Arrows coming from a file point to files it includes. Other dependencies exist, for example on Simulink header files `tmwtypes.h` and `simstruc_types.h`, plus C or C++ library files. The figure maps inclusion relations between only those files that are generated in the build folder. Utility and model reference code

located in a project folder might also be referenced by these files. See “Project Folder Structure for Model Reference Targets” on page 3-16 for details.

The figure shows that parent system header files (*model.h*) include all child subsystem header files (*subsystem.h*). In more layered models, subsystems similarly include their children’s header files, on down the model hierarchy. As a consequence, subsystems are able to recursively “see” into their descendants’ subsystems, as well as to see into the root system (because every *subsystem.c* or *subsystem.cpp* includes *model.h* and *model\_private.h*).

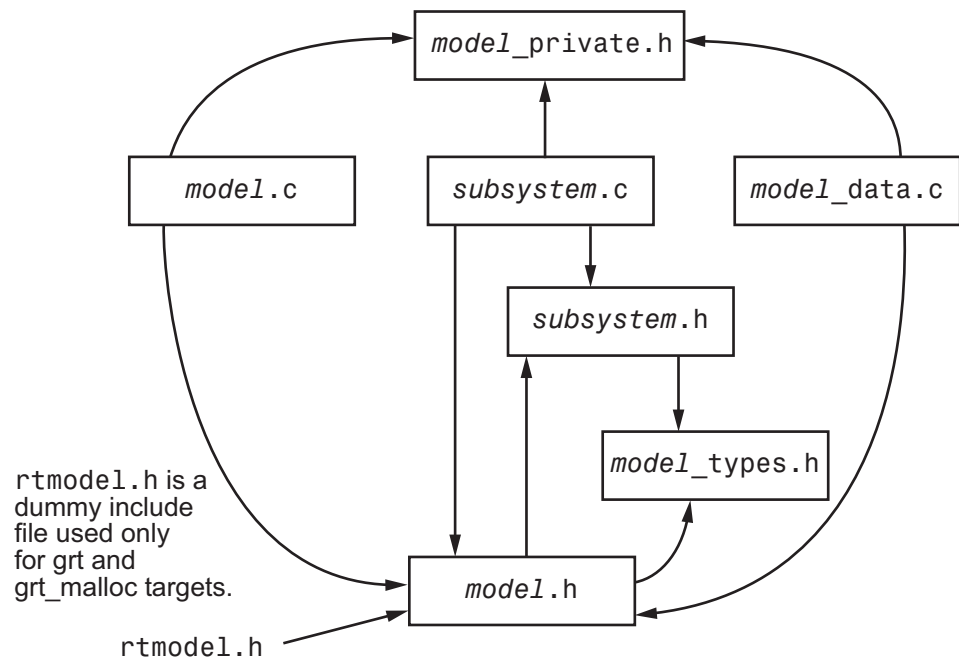

### Simulink® Coder™ Generated File Dependencies

**Note** In the preceding figure, files *model.h*, *model\_private.h*, and *subsystem.h* also depend on the Simulink Coder header file *rtwtypes.h*. Targets that are not based on the ERT target can have additional dependencies on *tmwtypes.h* and *simstruct\_types.h*.

## Header Dependencies When Interfacing Legacy/Custom Code with Generated Code

You can incorporate legacy or custom code into a Simulink Coder build in any of several ways. One common approach is by creating S-functions. For details on this approach, see “Insert S-Function Code” on page 14-46.

Another approach is to interface code using global variables created by declaring storage classes for signals and parameters. This requires customizing an outer code harness, typically referred to as a `main.c` or `main.cpp` file, to properly execute the generated code. In addition, the harness can contain custom code.

These scenarios require you to include header files specific to the Simulink Coder product to make available function declarations, type definitions, and defines to the legacy or custom code.

### `rtwtypes.h`

The header file `rtwtypes.h` defines data types, structures, and macros required by the generated code. Normally, you should include `rtwtypes.h` for both GRT and ERT targets instead of including `tmwtypes.h` or `simstruct_types.h`. However, the contents of the header file varies depending on your target selection.

For...	<code>rtwtypes.h</code>
GRT target	Provides a complete set of definitions by including <code>tmwtypes.h</code> and <code>simstruct_types.h</code> , both of which depend on <ul style="list-style-type: none"> <li>• System headers <code>limits.h</code> and <code>float.h</code></li> <li>• Simulink Coder headers: <code>rtw_matlogging.h</code>, <code>rtw_extmode.h</code>, <code>rtw_continuous.h</code>, and <code>rtw_solver.h</code></li> </ul>
ERT target and targets based on the ERT target	Is optimized, when possible, to include a minimum set of <code>#define</code> statements, enumerations, and so on; does not include <code>tmwtypes.h</code> and <code>simstruct_types.h</code>



The Simulink Coder build process generates the optimized version of `rtwtypes.h` for the ERT target when both of the following conditions exist:

- The **Classic call interface** option on the **Code Generation > Interface** pane of the Configuration Parameters dialog box is cleared.
- The model contains no noninlined S-functions

You should always include `rtwtypes.h`. If you include it for GRT targets, for example, it is easier to use your code with ERT-based targets.

#### **rtwtypes.h for GRT targets:**

```
#ifndef __RTWTYPES_H__
#define __RTWTYPES_H__
#include "tmwtypes.h"

/* This ID is used to detect inclusion of an incompatible
 * rtwtypes.h
 */
#define RTWTYPES_ID_C08S16I32L32N32F1

#include "simstruc_types.h"
#ifndef POINTER_T
# define POINTER_T
typedef void * pointer_T;
#endif
#ifndef TRUE
# define TRUE (1)
#endif
#ifndef FALSE
# define FALSE (0)
#endif
#endif
```

#### **Top of rtwtypes.h for ERT targets:**

```
#ifndef __RTWTYPES_H__
#define __RTWTYPES_H__
#ifndef __TMWTYPES__
#define __TMWTYPES__
```

```

#include <limits.h>

/*=====
 * Target hardware information
 * Device type: 32-bit Generic
 * Number of bits:   char:  8   short:  16   int:  32
 *                   long:  32   native word size:  32
 * Byte ordering: Unspecified
 * Signed integer division rounds to: Undefined
 * Shift right on a signed integer as arithmetic shift: on
 *=====*/

/* This ID is used to detect inclusion of an incompatible rtwtypes.h */
#define RTWTYPES_ID_C08S16I32L32N32F1

/*=====
 * Fixed width word size data types:
 * int8_T, int16_T, int32_T   - signed 8, 16, or 32 bit integers
 * uint8_T, uint16_T, uint32_T - unsigned 8, 16, or 32 bit integers
 * real32_T, real64_T       - 32 and 64 bit floating point numbers
 *=====*/

typedef signed char int8_T;
typedef unsigned char uint8_T;
typedef short int16_T;
typedef unsigned short uint16_T;
typedef int int32_T;
typedef unsigned int uint32_T;
typedef float real32_T;
typedef double real64_T;
. . .

```

For GRT and ERT targets, the location of `rtwtypes.h` depends on whether the build uses the *shared utilities* location. If you use a shared location, the Simulink Coder build process places `rtwtypes.h` in `s\prj\target\_sharedutils`; otherwise, it places `rtwtypes.h` in the standard build folder (*model\_target\_rtw*). See “Logging” on page 15-105 for more information on when and how to use the shared utilities location.

The header file `rtwtypes.h` should be included by source files that use Simulink Coder type names or other Simulink Coder definitions. A typical example is for files that declare variables using a Simulink Coder data type, for example, `uint32_T myvar;`.

A source file that is intended to be used by the Simulink Coder product and by a Simulink S-function can leverage the preprocessor macro `MATLAB_MEX_FILE`, which is defined by the `mex` function:

```
#ifndef MATLAB_MEX_FILE
#include "tmwtypes.h"
#else
#include "rtwtypes.h"
#endif
```

A source file meant to be used as the Simulink Coder `main.c` (or `.cpp`) file would also include `rtwtypes.h` without any preprocessor checks.

```
#include "rtwtypes.h"
```

Custom source files that are generated using the Target Language Compiler can also emit these `include` statements into their generated file.

### ***model.h***

The header file `model.h` declares model data structures and a public interface to the model entry points and data structures. This header file also provides an interface to the real-time model data structure (`model_M`) by using access macros. If your code interfaces to model functions or model data structures, as illustrated below, you should include `model.h`:

- Exported global signals

```
extern int32_T INPUT;    /* '<Root>/In' */
```

- Global structure definitions

```
/* Block parameters (auto storage) */
extern Parameters_mymodel mymodel_P;
```

- RTM macro definitions

```
#ifndef rtmGetSampleTime
# define rtmGetSampleTime(rtm, idx)
((rtm)->Timing.sampleTimes[idx])
#endif
```

- Model entry point functions (ERT example)

```
extern void mymodel_initialize(void);
extern void mymodel_step(void);
extern void mymodel_terminate(void);
```

A Simulink Coder target's `main.c` (or `.cpp`) file should include `model.h`. If the `main.c` (or `.cpp`) file is generated from a TLC script, the TLC source can include `model.h` using:

```
#include "%<CompiledModel.Name>.h"
```

If `main.c` or `main.cpp` is a static source file, a fixed header filename can be used, `rtmodel.h` for GRT or `autobuild.h` for ERT. These files include the `model.h` header file:

```
#include "model.h"      /* If main.c is generated */
```

or

```
#include "rtmodel.h"   /* If static main.c is used with GRT */
```

or

```
#include "autobuild.h" /* If static main.c is used with ERT */
```

Other custom source files might need to include `model.h` to interface to model data, for example exported global parameters or signals. The `model.h` file itself can have additional header dependencies, as listed in the tables System Header Files on page 10-11 and Simulink® Coder™ Header Files on page 10-13, due to requirements of generated code.

## System Header Files

Header File	Purpose	GRT Targets	ERT Targets
<float.h>	Defines math constants	Not included	Included when generated code honors the <b>Stop time</b> solver configuration parameter due to one of the following Simulink Coder interface option settings: <ul style="list-style-type: none"> <li>• <b>MAT-file logging</b> selected</li> <li>• <b>Interface</b> set to External mode</li> </ul>
<math.h>	Provides floating-point math functions	Included when the model contains a floating-point math function	Included when the model contains a floating-point math function that is not overridden by an entry in the code replacement library (CRL) selected for the model  For more information about CRLs, see “Selecting and Viewing Code Replacement Libraries” on page 9-61 in this chapter, and the CRL chapter in the Embedded Coder User’s Guide.
<stddef.h>	Defines NULL	Included when the model contains a utility function that needs it	Included when the model contains a utility function that needs it
<stdio.h>	Provides file I/O functions	Included when the model includes a To File block	Included when the model includes a To File block, or you open the Configuration Parameters dialog box and select <b>Code Generation &gt; Interface &gt; MAT-file logging</b> . See “MAT-file logging”.

**System Header Files (Continued)**

Header File	Purpose	GRT Targets	ERT Targets
<stdlib.h>	Provides utility functions such as <code>div()</code> and <code>abs()</code>	Included when the model includes <ul style="list-style-type: none"> <li>• A Stateflow chart</li> <li>• A Math Function block configured for <code>mod()</code> or <code>rem()</code>, which generate calls to <code>div()</code></li> </ul>	Included when the model includes <ul style="list-style-type: none"> <li>• A Stateflow chart and you select the <b>Support floating-point numbers</b> Simulink Coder interface configuration parameter</li> <li>• A Math Function block configured for <code>mod()</code> or <code>rem()</code>, which generate calls to <code>div()</code></li> </ul>
<string.h>	Provides memory functions such as <code>memset()</code> and <code>memcpy()</code>	Always included due to use of <code>memset()</code> in model initialization code	Included when block or model initialization code calls <code>memcpy()</code> or <code>memset()</code>  For a list of relevant blocks, enter <code>showblockdatatypeable</code> in the MATLAB Command Window and look for blocks with the N2 note.  To omit calls to <code>memset()</code> from model initialization code, select the <b>Remove root level I/O zero initialization</b> and <b>Remove internal data zero initialization</b> optimization configuration parameters.

## Simulink Coder Header Files

Header File	Purpose	GRT Targets	ERT Targets
<code>dt_info.h</code>	Defines data structures for external mode	Included when you configure a model for external mode	Included when you configure a model for external mode
<code>ext_work.h</code>	Defines external mode functions	Included when you configure a model for external mode	Included when you configure a model for external mode
<code>fixedpoint.h</code>	Provides fixed-point support for noninlined S-functions	Always included	Included when either of the following conditions exists: <ul style="list-style-type: none"> <li>The model uses noninlined S-functions</li> <li>You select the Simulink Coder interface configuration parameter <b>Classic call interface</b></li> </ul>
<code>model_types.h</code>	Defines model-specific data types	Always included	Always included
<code>rt_logging.h</code>	Supports MAT-file logging	Always included	Included when you open the Configuration Parameters dialog box and select <b>Code Generation &gt; Interface &gt; MAT-file logging</b> . See “MAT-file logging”.
<code>rt_nonfinite.h</code>	Provides support for nonfinite numbers in the generated code	Always included	Included when you select one of the following Simulink Coder interface configuration parameters: <ul style="list-style-type: none"> <li><b>MAT-file logging</b></li> <li><b>Support non-finite numbers</b> (and the generated code requires nonfinite numbers)</li> </ul>

**Simulink Coder Header Files (Continued)**

<b>Header File</b>	<b>Purpose</b>	<b>GRT Targets</b>	<b>ERT Targets</b>
rtw_continuous.h	Supports continuous time	Always included by simstruc_types.h	Included when you select the Simulink Coder interface configuration parameter <b>Support continuous time</b> and simstruc.h is not already included
rtw_extmode.h	Supports external mode	Always included by simstruc_types.h	Included when you configure the model for external mode and simstruc.h is not already included
rtw_matlogging.h	Supports MAT-file logging	Included by simstruc_types.h and rtw_logging.h	Included by rtw_logging.h
rtw_solver.h	Supports continuous states	Always included by simstruc_types.h	Included when you select the Simulink Coder interface configuration parameter <b>Support floating-point numbers</b> and simstruc.h is not already included
rtwtypes.h	Defines Simulink Coder data types; generated file	Always included; use the complete version of the file, which includes tmwtypes.h and simstruc_types.h (see simstruc_types.h for dependencies)	Always included; use the complete or optimized version of the file as explained in “rtwtypes.h” on page 10-6



**Simulink Coder Header Files (Continued)**

<b>Header File</b>	<b>Purpose</b>	<b>GRT Targets</b>	<b>ERT Targets</b>
<code>simstruc.h</code>	Provides support for calling noninlined S-functions that use the <code>Simstruct</code> definition; also includes <code>limits.h</code> , <code>string.h</code> , <code>tmwtypes.h</code> , and <code>simstruc_types.h</code>	Always included	Included when either of the following conditions exists: <ul style="list-style-type: none"> <li>The model uses noninlined S-functions</li> <li>You select the Simulink Coder interface configuration parameter <b>Classic call interface</b></li> </ul>
<code>simstruc_types.h</code>	Provides definitions used by generated code and includes the header files <code>rtw_matlogging.h</code> , <code>rtw_extmode.h</code> , <code>rtw_continuous.h</code> , <code>rtw_solver.h</code> , and <code>sysran_types.h</code>	Always included with <code>rtwtypes.h</code>	Not included; <code>rtwtypes.h</code> contains definitions and <code>model.h</code> contains header files
<code>sysran_types.h</code>	Supports external mode	Always included by <code>simstruc_types.h</code>	Included when you configure the model for external mode and <code>simstruc.h</code> is not already included

---

**Note** Header file dependencies noted in the preceding table apply to the system target files `grt.tlc` and `ert.tlc`. Targets derived from these base targets may have additional header dependencies. Also, code generation for blocks from blocksets, embedded targets, and custom S-functions may introduce additional header dependencies.

---

## Dependencies of the Generated Code

The Simulink Coder software can directly build standalone executables for the host system such as when using the GRT target. Several processor- and operating system-specific targets also provide automated builds using a cross-compiler. All of these targets are typically makefile-based interfaces for which the Simulink Coder software provides a “Template MakeFile (TMF) to makefile” conversion capability. Part of this conversion process is to include, in the generated makefile, source file, header file, and library file information (the dependencies) for a compilation.

In other instances, the generated model code needs to be integrated into a specific application. Or, it may be desired to enter the generated files and any file dependencies into a configuration management system. This section discusses the various aspects of the generated code dependencies and how to determine them.

Typically, the generated code for a model consists of a small set of files:

- *model.c* or *model.cpp*
- *model.h*
- *model\_data.c* or *model\_data.cpp*
- *model\_private.h*
- *rtwtypes.h*

These are generated in the build folder for a standalone model or a subfolder under the `slprj` folder for a model reference target. There is also a top-level `main.c` (or `.cpp`) file that calls the top model functions to execute the model. `main.c` (or `.cpp`) is a static (not generated) file (such as `grt_main.c` or `grt_main.cpp` for GRT-based targets), and is either a static file (`ert_main.c` or `ert_main.cpp`) or is dynamically generated for ERT-based targets.

The preceding files also have dependencies on other files, which occur due to:

- Including other header files
- Using macros declared in other header files
- Calling functions declared in other source files

- Accessing variables declared in other source files

These dependencies are introduced for a number of reasons such as:

- Blocks in a model generate code that makes function calls. This can occur in several forms:
  - The called functions are declared in other source files. In some cases such as a blockset, these source file dependencies are typically managed by compiling them into a library file.
  - In other cases, the called functions are provided by the compilers own run-time library, such as for functions in the ANSI<sup>12</sup> C header, `math.h`.
  - Some function dependencies are themselves generated files. Some examples are for fixed-point utilities and nonfinite support. These dependencies are referred to as shared utilities. The generated functions can appear in files in the build folder for standalone models or in the `_sharedutils` folder under the `slprj` folder for builds that involve model reference.
- Models with continuous time require solver source code files.
- Simulink Coder options such as external mode, C API, and MAT-file logging are examples that trigger additional dependencies.
- Specifying custom code can introduce dependencies.

## Providing the Dependencies

The Simulink Coder product provides several mechanisms for feeding file dependency information into the Simulink Coder build process. The mechanisms available to you depend on whether your dependencies are block based or are model or target based.

For block dependencies, consider using

- S-functions and blocksets
  - folders that contain S-function MEX-files used by a model are added to the header include path.

---

12. ANSI® is a registered trademark of the American National Standards Institute, Inc.

- Makefile rules are created for these folders to allow source code to be found.
- For S-functions that are not inlined with a TLC file, the S-function source filename is added to the list of sources to compile.
- The S-Function block parameter `SFunctionModules` provides the ability to specify additional source filenames.
- The `rtwmakecfg.m` mechanism provides further capability in specifying dependencies. See “Use `rtwmakecfg.m` API to Customize Generated Makefiles” on page 14-124 for more information.

For more information on applying these approaches to legacy or custom code integration, see “Integrate External Code Using Legacy Code Tool” on page 14-28.

- S-Function Builder block, which provides its own GUI for specifying dependency information

For model- or target-based dependencies, such as custom header files, consider using

- The **Code Generation > Custom Code** pane of the Configuration Parameters dialog box, which provides the ability to specify additional libraries, source files, and include folders.
- TLC functions `LibAddToCommonIncludes()` and `LibAddToModelSources()`, which allow you to specify dependencies during the TLC phase. See “`LibAddToCommonIncludes(incFileName)`” and “`LibAddSourceFileCustomSection` (file, builtInSection, newSection)” in the Target Language Compiler documentation for details. The Embedded Coder product also provides a TLC-based customization template capability for generating additional source files.

## **Makefile Considerations**

As previously mentioned, Simulink Coder targets are typically makefile based and the Simulink Coder product provides a “Template MakeFile (TMF) to makefile” conversion capability. The template makefile contains a token expansion mechanism in which the build process expands different tokens in the makefile to include the additional dependency information. The resulting

makefile contains the complete dependency information. See “Customize Template Makefiles” on page 24-75 for more information on working with template makefiles.

The generated makefile contains the following information:

- Names of the source file dependencies (by using various SRC variables)
- folders where source files are located (by using unique rules)
- Location of the header files (by using the INCLUDE variables)
- Precompiled library dependencies (by using the LIB variables)
- Libraries which need to be compiled and created (by using rules and the LIB variables)

A property of make utilities is that the specific location for a given source C or C++ file does not need to be specified. If a rule exists for that folder and the source filename is a prerequisite in the makefile, the make utility can find the source file and compile it. Similarly, the C or C++ compiler (preprocessor) does not require absolute paths to the headers. Given the name of header file by using an `#include` directive and an include path, it is able to find the header. The generated C or C++ source code depends on this standard compiler capability.

Also, libraries are typically created and linked against, but occlude the specific functions that are being used.

Although the build process succeeds and can create a minimum-size executable, these properties can make it difficult to manually determine the minimum list of file dependencies along with their fully qualified paths. The makefile can be used as a starting point to determining the dependencies that the generated model code has.

An additional approach to determining the dependencies is by using linker information, such as a linker map file, to determine the symbol dependencies. The location of Simulink Coder and blockset source and header files is provided below to assist in locating the dependencies.

## Simulink Coder Static File Dependencies

Several locations in the MATLAB folder tree contain static file dependencies specific to the Simulink Coder product:

- `matlabroot/rtw/c/src/`

This folder has subfolders and contains additional files that may need to be compiled. Examples include solver functions (for continuous time support), external mode support files, C API support files, and S-function support files. Source files in this folder are included into the build process using in the SRC variables of the makefile.

- `matlabroot/rtw/extern/include/*.h`
- `matlabroot/simulink/include/*.h`

These folders contain additional header file dependencies such as `tmwtypes.h`, `simstruc_types.h`, and `simstruc.h`.

---

**Note** For ERT-based targets, several header dependencies from the above locations can be avoided. ERT-based targets generate the minimum set of type definitions, macros, and so on, in the file `rtwtypes.h`.

---

## Blockset Static File Dependencies

Blockset products leverage the `rtwmakecfg.m` mechanism to provide the Simulink Coder software with dependency information. As such, the `rtwmakecfg.m` file provided by the blockset contains the listing of include path and source path dependencies for the blockset. Typically, blocksets create a library from the source files, which the generated model code can then link against. The libraries are created and identified using the `rtwmakecfg.m` mechanism.

To locate the `rtwmakecfg.m` files for blocksets in your MATLAB installed tree, use the following command:

```
>> which -all rtwmakecfg.m
```

For example, for the DSP System Toolbox product, the `which` command displays a path similar to the following:

C:\Program Files\MATLAB\toolbox\dspblks\dspmex\rtwmakecfg.m

If the model being compiled uses one or more of the blocksets listed by the `which` command, you can determine folder and file dependency information from the respective `rtwmakecfg.m` file. For example, here is an excerpt of the `rtwmakecfg.m` file for the DSP System Toolbox product.

```
function makeInfo=rtwmakecfg()
%RTWMAKECFG adds include and source directories to RTW make files.
% makeInfo=RTWMAKECFG returns a structured array containing build info.
% Please refer to the rtwmakecfg API section in the Simulink Coder
% documentation for details on the format of this structure.

.
.
.

makeInfo.includePath = { ...
    fullfile(matlabroot,'toolbox','dspblks','include') };

makeInfo.sourcePath = {};
```

## Specify Include Paths in Simulink Coder Generated Source Files

You can add `#include` statements to generated code. Such references can come from several sources, including TLC scripts for inlining S-functions, custom storage classes, bus objects, and data type objects. The included files typically consist of header files for legacy code or other customizations. Additionally, you can specify compiler include paths with the `-I` compiler option. The Simulink Coder build process uses the specified paths to search for included header files.

Usage scenarios for the generated code include, but are not limited to, the following:

- Simulink Coder generated code is compiled with a custom build process that requires an environment-specific set of `#include` statements.

In this scenario, the code generator is likely invoked with the **Generate code only** check box selected. Consider using fully qualified paths, relative

paths, or just the header filenames in the `#include` statements, and additionally leverage include paths.

- The generated code is compiled using the Simulink Coder build process.

In this case, compiler include paths (`-I`) can be provided to the Simulink Coder build process in several ways:

- The **Code Generation > Custom Code** pane of the Configuration Parameters dialog box allows you to specify additional include paths. The include paths are propagated into the generated makefile when the template makefile (TMF) is converted to the actual makefile.
- The `rtwmakecfg.m` mechanism allows S-functions to introduce additional include paths into the Simulink Coder build process. The include paths are propagated when the template makefile (TMF) is converted to the actual makefile.
- When building a custom Simulink Coder target that is makefile-based, the desired include paths can be directly added into the targets template makefile.
- A `USER_INCLUDES` make variable that specifies a folder in which the Simulink Coder build process should search for included files can be specified on the Simulink Coder make command. For example,

```
make_rtw USER_INCLUDES=-Id:\work\feature1
```

The user includes are passed to the command-line invocation of the make utility, which will add them to the overall flags passed to the compiler.

### **Recommended Approaches**

The following are recommended approaches for using `#include` statements and include paths in conjunction with the Simulink Coder build process to generate code that remains portable and minimizes compatibility problems with future versions.

Assume that additional header files are located at

```
c:\work\feature1\foo.h  
c:\work\feature2\bar.h
```



- A simple approach is to include in the `#include` statements only the filename, such as

```
#include "foo.h"  
#include "bar.h"
```

Then, the include path passed to the compiler should contain all folders in which the headers files exist:

```
cc -Ic:\work\feature1 -Ic:\work\feature2    ...
```

- A second recommended approach is to use relative paths in `#include` statements and provide an anchor folder for these relative paths using an include path, for example,

```
#include "feature1\foo.h"  
#include "feature2\bar.h"
```

Then specify the anchor folder (for example `\work`) to the compiler:

```
cc -Ic:\work    ...
```

### Folder Dependencies to Avoid

When using the Simulink Coder build process, avoid dependencies on its build and project folder structure, such as the `model_ert_rtw` build folder or the `slprj` project folder. Thus, the `#include` statements should not just be relative to where the generated source file exists. For example, if your MATLAB current working folder is `c:\work`, a generated `model.c` source file would be generated into a subfolder such as

```
c:\work\model_ert_rtw\model.c
```

The `model.c` file would have `#include` statements of the form

```
#include "..\feature1\foo.h"  
#include "..\feature2\bar.h"
```

However, as this creates a dependency on the Simulink Coder folder structure, you should instead use one of the approaches described above.

## Files and Folders Created by Build Process

The following sections discuss

- “Files Created During the Build Process” on page 10-24
- “Folders Used During the Build Process” on page 10-28

### Files Created During the Build Process

This section lists *model.\** files created during the code generation and build process for the GRT and GRT malloc targets when used with stand-alone models. Additional folders and files are created to support shared utilities and model references.

The build process derives many of the files from the model file you create with Simulink. You can think of the model file as a very high-level programming language source file.

---

**Note** Files generated by the Embedded Coder build process are packaged slightly differently. Depending on model architectures and code generation options, the Simulink Coder build process might generate other files.

---

Descriptions of the principal generated files follow. Note that these descriptions use the generic term *model* for the model name:

- *model.rtw*

An ASCII file, representing the compiled model, generated by the Simulink Coder build process. This file is analogous to the object file created from a high-level language source program. By default, the Simulink Coder build process deletes this file when the build process is complete. However, you can choose to retain the file for inspection.

- *model.c*

C source code that corresponds to the model file and is generated by the Target Language Compiler. This file contains

- Include files *model.h* and *model\_private.h*

- All data except data placed in *model\_data.c*
- Model-specific scheduler code
- Model-specific solver code
- Model registration code
- Algorithm code
- Optional GRT wrapper functions
- *model.h*

Defines model data structures and a public interface to the model entry points and data structures. Also provides an interface to the real-time model data structure (*model\_rtM*) via access macros. *model.h* is included by subsystem *.c* files in the model. It includes

  - Exported Simulink data symbols
  - Exported Stateflow machine parented data
  - Model data structures, including *rtM*
  - Model entry point functions
- *model\_private.h*

Contains local `define` constants and local data required by the model and subsystems. This file is included by the generated source files in the model. You might need to include *model\_private.h* when interfacing legacy hand-written code to a model. See “Header Dependencies When Interfacing Legacy/Custom Code with Generated Code” on page 10-6 for more information. This header file contains

  - Imported Simulink data symbols
  - Imported Stateflow machine parented data
  - Stateflow entry points
  - Simulink Coder details (various macros, enums, and so forth that are private to the code)
- *model\_types.h*

Provides forward declarations for the real-time model data structure and the parameters data structure. These structure might be used by function

declarations of reusable functions. *model\_types.h* is included by all the generated header files in the model.

- *model\_data.c*

A conditionally generated C source code file containing declarations for the parameters data structure and the constant block I/O data structure, and any zero representations for structure data types that are used in the model. If these data structures are not used in the model, *model\_data.c* is not generated. Note that these structures are declared extern in *model.h*. When present, this file contains

- Constant block I/O parameters
- Include files *model.h* and *model\_private.h*
- Definitions for the zero representations for any user-defined structure data types used by the model
- Constant parameters

- *model.exe* (Microsoft Windows platforms) or *model* (UNIX platforms), generated in the current folder, not in the build folder

Executable program file created under control of the `make` utility by your development system (unless you have explicitly specified that Simulink Coder generate code only and skip the rest of the build process)

- *model.mk*

Customized makefile generated by the Simulink Coder build process. This file builds an executable program file.

- *rtmodel.h*

Contains `#include` directives required by static main program modules such as *grt\_main.c* and *grt\_malloc\_main.c*. Since these modules are not created at code generation time, they include *rt\_model.h* to access model-specific data structures and entry points. If you create your own main program module, take care to include *rtmodel.h*.

- *rtwtypes.h*

For GRT targets, a header file that includes *simstruc\_types.h*, which, in turn, includes *tmwtypes.h*. For Embedded Coder ERT targets, *rtwtypes.h* provides the defines, enums, and so on, instead of including *tmwtypes.h* and *simstruc\_types.h*. The *rtwtypes.h* file generated for

ERT is an optimized (reduced) file based on the settings provided with the model that is being built. See “Header Dependencies When Interfacing Legacy/Custom Code with Generated Code” on page 10-6 in the Simulink Coder documentation for more information.

- *rt\_nonfinite.c*

C source file that declares and initializes global nonfinite values for *inf*, *minus inf*, and *nan*. Nonfinite comparison functions are also provided. This file is always generated for GRT-based targets and optionally generated for other targets.

- *rt\_nonfinite.h*

C header file that defines *extern* references to nonfinite variables and functions. This file is always generated for GRT-based targets and optionally generated for other targets.

- *rtw\_proj.tmw*

Simulink Coder file generated for the *make* utility to use to determine when to rebuild objects when the name of the current Simulink Coder project changes

- *model.bat*

Windows batch file used to set up the compiler environment and invoke the *make* command

- *modelsources.txt*

List of additional sources that should be included in the compilation.

Optional files:

- *model\_targ\_data\_map.m*

MATLAB language file used by external mode to initialize the external mode connection

- *model\_dt.h*

C header file used for supporting external mode. Declares structures that contain data type and data type transition information for generated model data structures.

- *subsystem.c*

C source code for each noninlined nonvirtual subsystem or copy thereof when the subsystem is configured to place code in a separate file

- *subsystem.h*

C header file containing exported symbols for noninlined nonvirtual subsystems. Analogous to *model.h*.

- *model\_capi.h*, *model\_capi.c*

Header and sources file that contain data structures that describe the model's signals, states, and parameters without using external mode. See “Data Interchange Using the C API” on page 15-137 in Simulink Coder User's Guide for more information.

- *rt\_sfcn\_helper.h*, *rt\_sfcn\_helper.c*

Header and source files providing functions used by noninlined S-functions in a model. The functions *rt\_CallSys*, *rt\_enableSys*, and *rt\_DisableSys* are used when noninlined S-functions call downstream function-call subsystems.

In addition, when you select the **Create code generation report** check box, the Simulink Coder software generates a set of HTML files (one for each source file plus a *model\_contents.html* index file) in the *html* subfolder within your build folder.

The above source files have dependency relationships, and there are additional file dependencies that you might need to take into account. These are described in “Generated Source Files and File Dependencies” on page 10-4 in the Simulink Coder documentation.

## Folders Used During the Build Process

The Simulink Coder build process places output files in three folders:

- The working folder

If you choose to generate an executable program file, the Simulink Coder build process writes the file *model.exe* (Windows) or *model* (UNIX) to your working folder.

- The build folder — *model\_target\_rtw*

A subfolder within your working folder. The build folder name is *model\_target\_rtw*, where *model* is the name of the source model and *target* is the selected target type (for example, *grt* for the generic real-time target). The build folder stores generated source code and all other files created during the build process (except the executable program file).

- Project folder — *slprj*

A subfolder within your working folder. When models referenced via Model blocks are built for simulation or Simulink Coder code generation, files are placed in *slprj*. The Embedded Coder configuration has an option that places generated shared code in *slprj* without the use of model reference. Subfolders in *slprj* provide separate places for simulation code, some Simulink Coder code, utility code shared between models, and other files. Of particular importance to Simulink Coder users are:

- Header files from models referenced by this model  
`slprj/target/model/referenced_model_includes`
- Model reference Simulink Coder target files  
`slprj/target/model`
- MAT-files used during code generation of model reference Simulink Coder target and stand-alone code generation  
`slprj/target/model/tmwinternal`
- Shared (fixed-point) utilities  
`slprj/target/_sharedutils`

See “Work with Project Folders” on page 3-14 for more information on organizing your files with respect to project folders.

The build folder always contains the generated code modules *model.c*, *model.h*, and the generated makefile *model.mk*.

Depending on the target, code generation, and build options you select, the build folder might also include

- *model.rtw*
- Object files (*.obj* or *.o*)

- Code modules generated from subsystems
- HTML summary reports of files generated (in the `html` subfolder)
- TLC profiler report files
- Block I/O, state, and parameter tuning information file (*model\_capi.c*)
- Simulink Coder project (*model.tmw*) files

For additional information about using project folders, see “Project Folder Structure for Model Reference Targets” on page 3-16 and “Customize Build to Use Shared Utility Code” on page 22-34 in the Simulink Coder documentation.



## How Code Is Generated From a Model

In this section...
“Model Compilation” on page 10-31
“Code Generation” on page 10-31

### Model Compilation

The build process begins with the Simulink software compiling the block diagram. During this stage, Simulink

- Evaluates simulation and block parameters
- Propagates signal widths and sample times
- Determines the execution order of blocks within the model
- Computes work vector sizes, such as those used by S-functions. (For more information about work vectors, see “DWork Vector Basics”).

When Simulink completes this processing, it compiles an intermediate representation of the model. This intermediate description is stored in a language-independent format in the ASCII file *model.rtw*. The *model.rtw* file is the input to the next stage of the build process. For a general description of the *model.rtw* file format, see “model.rtw file”.

### Code Generation

The Simulink Coder code generator uses the Target Language Compiler (TLC) and a supporting TLC function library to transform the intermediate model description stored in *model.rtw* into target-specific code.

The target language compiled by the TLC is an interpreted programming language designed to convert a model description to code. The TLC executes a TLC program comprising several target files (.tlc scripts). The TLC scripts specify how to generate code from the model, using the *model.rtw* file as input.

The TLC

- 1 Reads the *model.rtw* file

## 2 Compiles and executes commands in a system target file

The system target file is the entry point or main file. You select it from those available on the MATLAB path with the system target file browser or you can type the name of any such file on your system prior to building.

## 3 Compiles and executes commands in block-level target files

For blocks in the Simulink model, there is a corresponding target file that is either dynamically generated or statically provided.

---

**Note** The Simulink Coder software executes all user-written S-function target files, but optionally executes block target files for Simulink blocks.

---

## 4 Writes a source code version of the Simulink block diagram

## Code Generation of Matrices and Arrays

### In this section...

“Simulink® Coder™ Matrix Parameters” on page 10-34

“Internal Data Storage for Complex Number Arrays” on page 10-36

MATLAB, Simulink, and Simulink Coder software store matrix data and arrays(1–D, 2–D, ...) in column-major format as a vector. Column-major format orders elements in a matrix starting from the first column, top to bottom, and then moving on to the next column. For example, the following 3x3 matrix:

```
A =
     1     2     3
     4     5     6
     7     8     9
```

translates to an array of length 9 in the following order:

```
A(1) = A(1,1) = 1;
A(2) = A(2,1) = 4;
A(3) = A(3,1) = 7;
A(4) = A(1,2) = 2;
A(5) = A(2,2) = 5;
```

and so on.

In column-major format, the next element of an array in memory is always accessed by incrementing the first index of the array. For example, these element pairs are stored sequentially in memory:  $A(i)$  and  $A(i+1)$ ,  $B(i, j)$  and  $B(i+1, j)$ ,  $C(i, j, k)$  and  $C(i+1, j, k)$ . For more information on the internal representation of MATLAB data, see “MATLAB Data” in the MATLAB External Interfaces document.

Code generation software uses column-major format for several reasons:

- The world of signal and array processing is largely column major: MATLAB, LAPack, Fortran90, DSP libraries.

- A column is equivalent to a channel in frame-based processing. In this case, column-major storage is more efficient.
- A column major array is self-consistent with its component submatrices:
  - A column major 2-D array is a simple concatenation of 1-D arrays.
  - A column major 3-D array is a simple concatenation of 2-D arrays.
  - The stride of the first dimension is always 1 element, where the stride is the number of memory locations to index to the next element in the same dimension. The stride of the n'th dimension element is always the product of sizes of the lower dimensions.
  - Row-major n-D arrays have their stride of 1 for the highest dimension. Any submatrix manipulations are typically accessing a scattered data set in memory, which does not allow for efficient indexing.

## Simulink Coder Matrix Parameters

The compiled model file, *model.rtw*, represents matrices as strings in MATLAB syntax, with no implied storage format. This format allows you to copy the string out of an *.rtw* file and paste it into a MATLAB file and have it recognized by MATLAB.

Simulink Coder software declares Simulink block matrix parameters as scalar or 1-D array variables

```
real_T scalar;  
real_T mat[ nRows * nCols ];
```

where *real\_T* can be any of the data types supported by Simulink, and matches the variable type given in the model file.

For example, the 3-by-3 matrix in the 2-D Look-Up Table block

```
1  2  3  
4  5  6  
7  8  9
```

is stored in *model.rtw* as

```
Parameter {
```

```

    Name      "OutputValues"
    Value      Matrix(3,3)
[[1.0, 2.0, 3.0]; [4.0, 5.0, 6.0]; [7.0, 8.0, 9.0];]
    String     "t"
    StringType "Variable"
    ASTNode {
        IsNonTerminal      0
        Op      SL_NOT_INLINED
        ModelParameterIdx      3
    }
}

```

and results in this definition in *model.h*

```

typedef struct Parameters_tag {
    real_T s1_Look_Up_Table_2_D_Table[9];
        /* Variable:s1_Look_Up_Table_2_D_Table
        * External Mode Tunable:yes
        * Referenced by block:
        * <S1>/Look-Up Table (2-D
        */

    [ ... other parameter definitions ... ]

} Parameters;

```

The *model.h* file declares the actual storage for the matrix parameter and you can see that the format is column-major.

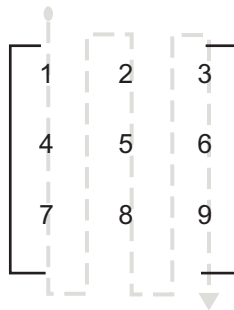

```
Parameters model_P = {
```

```
/* 3 x 3 matrix s1_Look_Up_Table_2_D_Table */  
{ 1.0, 4.0, 7.0, 2.0, 5.0, 8.0, 3.0, 6.0, 9.0 },  
[ ... other parameter declarations ... ]  
};
```

---

**Note** C typically uses row-major format, while MATLAB and Simulink use column-major format. The code generation software cannot be configured to generate code with row-major ordering. If you are integrating other C code with the generated code, you might need to transpose the data into column-major format as a 1-D array.

---

## Internal Data Storage for Complex Number Arrays

Simulink and Simulink Coder internal data storage formatting differs from MATLAB internal data storage formatting only in the storage of complex number arrays. In MATLAB, the real and imaginary parts are stored in separate arrays. In the Simulink and Simulink Coder products they are stored in an "interleaved" format, where the numbers in memory alternate real, imaginary, real, imaginary, and so forth. This convention allows efficient implementations of small signals on Simulink lines and for Mux blocks and other "virtual" signal manipulation blocks (i.e., they don't actively copy their inputs, merely the references to them).

## Shared Utility Code

### In this section...

“About Shared Utility Code” on page 10-37

“Controlling Shared Utility Code Placement” on page 10-38

“rtwtypes.h and Shared Utility Code” on page 10-38

“Incremental Shared Utility Code Generation and Compilation” on page 10-39

“Shared Utility Checksum” on page 10-39

“Shared Fixed-Point Utility Functions” on page 10-41

“Share User-Defined Data Types Across Models” on page 10-43

### About Shared Utility Code

Blocks in a model can require common functionality to implement their algorithm. In many cases, it is most efficient to modularize this functionality into standalone support or helper functions, rather than inlining the code for the functionality for each block instance.

Typically, functions that can have multiple callers are packaged into a library. Traditionally, such functions are defined statically, that is, the function source code exists in a file before you use the Simulink Coder software to generate code for your model.

In other cases, several model- and block-specific properties can affect which functions are used and their behavior. Additionally, these properties can affect type definitions (for example, `typedef`) in shared utility header files. Since there are many possible combinations of properties that determine unique behavior, it is not practical to statically define all possible function files before code generation. Instead, you can use the Simulink Coder shared utility mechanism, which generates support functions during code generation process.

## Controlling Shared Utility Code Placement

You control the shared utility code placement mechanism with the **Shared code placement** option on the **Code Generation > Interface** pane of the Configuration Parameters dialog box. By default, the option is set to **Auto**. For this setting, if the model being built does not include any Model blocks, the Simulink Coder build process places any code required for fixed-point and other utilities in one of the following:

- The `model.c` or `model.cpp` file
- In a separate file in the Simulink Coder build folder (for example, `vdp_grt_rtw`)

Thus, the code is specific to the model.

If a model does contain Model blocks, the Simulink Coder build process creates and uses a shared utilities folder within `s1prj`. Model reference builds require the use of shared utilities. The naming convention for shared utility folders is `s1prj/target/_sharedutils`, where `target` is `sim` for simulations with Model blocks or the name of the system target file for Simulink Coder target builds. Some examples follow:

```
s1prj/sim/_sharedutils      % folder used with simulation
s1prj/grt/_sharedutils     % folder used with grt.tlc STF
s1prj/ert/_sharedutils     % folder used with ert.tlc STF
s1prj/mytarget/_sharedutils % folder used with mytarget.tlc STF
```

To force a model build to use the `s1prj` folder for shared utility generation, even when the current model contains no Model blocks, set the **Shared code placements** option to **Shared location**. This forces the Simulink Coder build process to place utilities under the `s1prj` folder rather than in the normal Simulink Coder build folder. This setting is useful when you are manually combining code from several models, as it prevents symbol collisions between the models.

## rtwtypes.h and Shared Utility Code

The generated header file `rtwtypes.h` provides defines, enumerations, and so on. The location of this file is controlled by whether the build process is using the shared utilities folder. Typically, the Simulink Coder build



process places `rtwtypes.h` in the standard build folder, `model_target_rtw`. However, if a shared folder is required, the product places `rtwtypes.h` in `slprj/target/_sharedutils`.

## Incremental Shared Utility Code Generation and Compilation

As explained in “Controlling Shared Utility Code Placement” on page 10-38, you can specify that C source files, which contain function definitions, and header files, which contain macro definitions, be generated in a shared utilities folder. For the purpose of this discussion, the term functions means functions and macros.

A shared function can be used by blocks within the same model and by blocks in different models when using model reference or when building multiple standalone models from the same start build folder. However, the Simulink Coder software generates the code for a given function only once for the block that first triggers code generation. As the product determines the need to generate function code for subsequent blocks, it performs a file existence check. If the file exists, the function is not regenerated. Thus, the shared utility code mechanism requires that a given function and file name represent the same functional behavior regardless of which block or model generates the function. To satisfy this requirement:

- Model properties that affect function behavior are included in a shared utility checksum or affect the function and file name.
- Block properties that affect the function behavior also affect the function and file name.

During compilation, makefile rules for the shared utilities folder are configured to compile only new C files, and incrementally archive the object file into the shared utility library, `rtwshared.lib` or `rtwshared.a`. Thus, incremental compilation is also done.

## Shared Utility Checksum

As explained in “Incremental Shared Utility Code Generation and Compilation” on page 10-39, the Simulink Coder software uses the shared utilities folder when you explicitly configure a model to use the

shared location or the model contains Model blocks. During the code generation process, if relative to the current folder, the configuration file `slprj/target/_sharedutils/checksummap.mat` exists, the product reads that file and makes sure that the current model being built has identical settings for the required model properties. If mismatches occur between the properties defined in `checksummap.mat` and the current model properties, a Warning dialog appears.

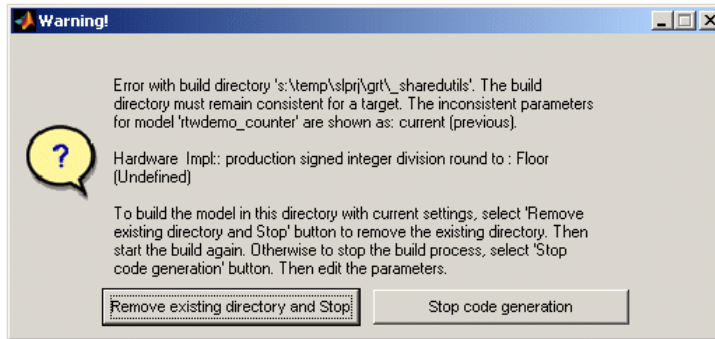

The following table lists properties that must match for the shared utility checksum.

Category	Properties
Hardware Implementation configuration properties	<pre> get_param(bdroot, 'TargetShiftRightIntArith') get_param(bdroot, 'TargetEndianness') get_param(bdroot, 'ProdEndianness') get_param(bdroot, 'TargetBitPerChar') get_param(bdroot, 'TargetBitPerShort') get_param(bdroot, 'TargetBitPerInt') get_param(bdroot, 'TargetBitPerLong') get_param(bdroot, 'ProdHWWordLengths') get_param(bdroot, 'TargetWordSize') get_param(bdroot, 'ProdWordSize') get_param(bdroot, 'TargetHWDeviceType') get_param(bdroot, 'ProdHWDeviceType')                     </pre>

Category	Properties
	<pre>get_param(bdroot, 'TargetIntDivRoundTo')</pre> <pre>get_param(bdroot, 'ProdIntDivRoundTo')</pre>
Additional configuration properties	<pre>get_param(bdroot, 'TargetLibSuffix')</pre> <pre>get_param(bdroot, 'TargetLang')</pre> <pre>get_param(bdroot, 'TemplateMakefile')</pre>
ERT target properties	<pre>get_param(bdroot, 'PurelyIntegerCode')</pre> <pre>get_param(bdroot, 'SupportNonInlinedSFcns')</pre>
Platform property	Return value of the computer command

## Shared Fixed-Point Utility Functions

An important set of generated functions that are placed in the shared utility folder are the fixed-point support functions. Based on model and block properties, there are many possible versions of fixed-point utilities functions that make it impractical to provide a complete set as static files. Generating only the required fixed-point utility functions during the code generation process is an efficient alternative.

The shared utility checksum mechanism makes sure that several critical properties are identical for all models that use the shared utilities. For the fixed-point functions, there are additional properties that affect function behavior. These properties are coded into the functions and file names to maintain requirements. The additional properties include

Category	Function/Property
Block properties	<ul style="list-style-type: none"> <li>• Fixed-point operation being performed by the block</li> <li>• Fixed-point data type and scaling (Slope, Bias) of function inputs and outputs</li> <li>• Overflow handling mode (Saturation, Wrap)</li> <li>• Rounding Mode (Floor, Ceil, Zero)</li> </ul>
Model properties	<pre>get_param(bdroot, 'NoFixptDivByZeroProtection')</pre>

The naming convention for the fixed-point utilities is based on the properties as follows:

```
operation + [zero protection] + output data type + output bits +
[input1 data] + input1 bits + [input2 data type + input2 bits] +
[shift direction] + [saturate mode] + [round mode]
```

Below are examples of generated fixed-point utility files, the function or macro names in the file are identical to the file name without the extension.

```
FIX2FIX_U12_U16.c
FIX2FIX_S9_S9_SR99.c
ACCUM_POS_S30_S30.h
MUL_S30_S30_S16.h
div_nzp_s16s32_floor.c
div_s32_sat_floor.c
```

For these examples, the respective fields correspond as follows:

Operation	FIX2FIX	FIX2FIX	ACCUM_POS	MUL	div	div
Zero protection	NULL	NULL	NULL	NULL	_nzp	NULL
Output data type	_U	_S	_S	_S	_s	_s
Output bits	12	9	30	30	16	32
Input data type	_U	_S	_S	_S [and _S]	s	NULL
Input bits	16	9	30	30 [and 16]	32	NULL
Shift direction	NULL	SR99	NULL	NULL	NULL	NULL
Saturate mode	NULL	NULL	NULL	NULL	NULL	_sat
Round mode	NULL	NULL	NULL	NULL	_floor	_floor

---

**Note** For the ACCUM\_POS example, the output variable is also used as one of the input variables. Therefore, only the output and second input is contained in the file and macro name. For the second div example, both inputs and the output have identical data type and bits. Therefore, only the output is included in the file and function name.

---

## Share User-Defined Data Types Across Models

- “About Sharing Data Types” on page 10-43
- “Example: Sharing Simulink Data Type Objects” on page 10-44
- “Example: Sharing Enumerated Data Types” on page 10-45

### About Sharing Data Types

By default, user-defined data types that are shared among multiple models generate duplicate type definitions in the `model_types.h` file for each model. However, Simulink Coder software provides the ability to generate user-defined data type definitions into a header file in the `_sharedutils` folder that can be shared across multiple models, removing the need for duplicate copies of the data type definitions. User-defined data types that you can set up in a shared header file include:

- Simulink data type objects that you instantiate from the classes `Simulink.AliasType`, `Simulink.Bus`, and `Simulink.NumericType`.
- Enumeration types that you define in MATLAB code

The general procedure for setting up user-defined data types to be shared among multiple models is as follows:

- 1** Define the data type.
- 2** Set data scope and header file properties that allow the data type to be shared.
- 3** Use the data type as a signal type in your models.
- 4** Before generating code for each model, set the **Shared code placement** parameter on the **Code Generation > Interface** pane of the Configuration Parameters dialog box to the value `Shared location`.
- 5** Generate code.

---

**Note** You can configure the definition of the user-defined data type to occur in a header file that is located in the `_sharedutils` folder, however user-defined data type names are not used by the shared utility functions that are generated into the `_sharedutils` folder. Currently, the user-defined data type names are used only by model code located in code folders for each model.

---

For more information, see “Example: Sharing Simulink Data Type Objects” on page 10-44 and “Example: Sharing Enumerated Data Types” on page 10-45.

### Example: Sharing Simulink Data Type Objects

To export a user-defined Simulink data type object for sharing among multiple models.

**1** In the base workspace, create a data type object of one of the following classes:

- `Simulink.AliasType`
- `Simulink.Bus`
- `Simulink.NumericType`

For example:

```
a = Simulink.AliasType
```

**2** To specify that the data type should be exported to a specified header file, use the data type object property `DataScope`. Specify the value `'Exported'` for the `DataScope` property. For example:

```
a.DataScope = 'Exported'
```

**3** To specify the name of the header file to which the data type should be exported, use the data type object property `HeaderFile`. For example:

```
a.HeaderFile = 'a.h'
```

Alternatively, if you leave the `HeaderFile` value empty, the name of the generated header file defaults to the name of the data type, in this case, `a.h`.

- 4 Use the data type object as a signal type in a model.
- 5 Before generating code, if you want to generate the header file into the shared utilities folder for sharing definitions between multiple models, set the **Shared code placement** parameter on the **Code Generation > Interface** pane of the Configuration Parameters dialog box to the value `Shared location`.
- 6 Generate code. Here is an example of the definition code that is generated to `a.h` in the shared utilities folder:

```
#ifndef RTW_HEADER_a_h_
#define RTW_HEADER_a_h_
#include "rtwtypes.h"

typedef double a;

#endif      /* RTW_HEADER_a_h_ */
```

To share the data type definition from other models, the alternatives include:

- Simply use the same workspace variable in multiple models. If the contents of the data type object are the same, generating code will not regenerate the header file. For example, model A and model B can export the same data type to the same header file in the shared utilities folder.
- Define the same data type object in other models, but set it up to import the shared data type definition from the header file. Specify the value 'Imported' for the data type object property `DataScope`. For example:

```
a = Simulink.AliasType
a.DataScope = 'Imported'
a.HeaderFile = 'a.h'
```

### Example: Sharing Enumerated Data Types

To export a user-defined enumerated data type for sharing among multiple models:

- 1 Define an enumerated data type in MATLAB code. For example, the following MATLAB file defines `BasicColors`:

```
% BasicColors.m
classdef(Enumeration) BasicColors < Simulink.IntEnumType
    enumeration
        Red(0)
        Yellow(1)
        Blue(2)
    end
    methods (Static = true)
        function retVal = getDefaultvalue()
            retVal = BasicColors.Blue;
        end
    end
end
```

- 2** To specify that the data type should be exported to a specified header file, you must override the default `getDataScope` method of the enumerated class. Specify the value 'Exported' as the `getDataScope` return value. For example:

```
methods (Static = true)
...
    function retVal = getDataScope()
        retVal = 'Exported';
    end
...
end
```

- 3** To specify the name of the header file to which the data type should be exported, you must override the default `getHeaderFile` method of the enumerated class. Specify a file name as the `getHeaderFile` return value. For example:

```
methods (Static = true)
...
    function retVal = getHeaderFile()
        retVal = 'BasicColors.h';
    end
...
end
```



Alternatively, if you leave the return value of the `getHeaderFile` method unspecified, the name of the generated header file defaults to the name of the data type, in this case, `BasicColors.h`.

- 4** Here is `BasicColors.m` after the data scope and header file changes.

```
% BasicColors.m
classdef(Enumeration) BasicColors < Simulink.IntEnumType
    enumeration
        Red(0)
        Yellow(1)
        Blue(2)
    end
    methods (Static = true)
        function retVal = getDefaultvalue()
            retVal = BasicColors.Blue;
        end
        function retVal = getDataScope()
            retVal = 'Exported';
        end
        function retVal = getHeaderFile()
            retVal = 'BasicColors.h';
        end
    end
end
```

Make sure `BasicColors.m` is present in the MATLAB path.

- 5** Use the type `enum:BasicColors` as a signal type in a model.
- 6** Before generating code, if you want to generate the header file into the shared utilities folder for sharing definitions between multiple models, set the **Shared code placement** parameter on the **Code Generation > Interface** pane of the Configuration Parameters dialog box to the value `Shared` location.
- 7** Generate code. Here is an example of the definition code that is generated to `BasicColors.h` in the shared utilities folder:

```
#ifndef RTW_HEADER_BasicColors_h
#define RTW_HEADER_BasicColors_h
```

```
/* Type definition for enum:BasicColors type */
typedef enum {
    Red = 0,
    Yellow,
    Blue
} BasicColors;
#endif
```

To share the data type definition from other models, the alternatives include:

- Simply use the same enumerated type as a signal type in multiple models. If the contents of the enumerated type are the same, generating code will not regenerate the header file. For example, model A and model B can export the same data type to the same header file in the shared utilities folder.
- Define the same enumerated type in other models, but set it up to import the shared data type definition from the header file. In the enumerated type definition file, specify the value 'Imported' as the `getDataScope` return value. For example:

```
methods (Static = true)
...
    function retVal = getDataScope()
        retVal = 'Imported';
    end
...
end
```

## Generating Code Using Simulink Coder™

This example shows how to select a target for a Simulink model, generate C code for real-time simulation, and view generated files.

1. Open the model.

```
model='rtwdemo_rtwintro';
open_system(model)
```

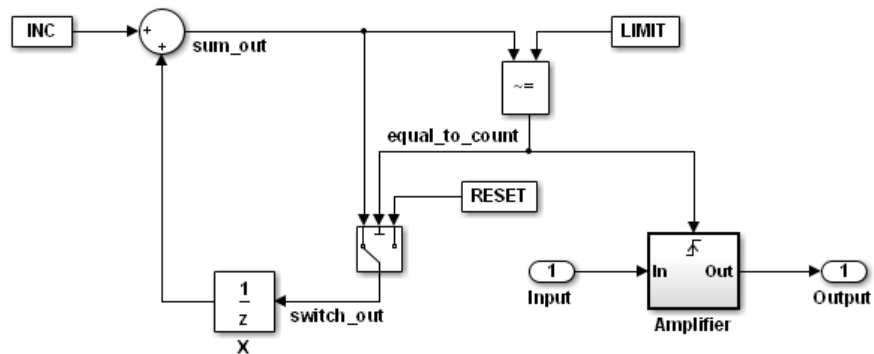

### Algorithm Description

An 8-bit counter feeds a triggered subsystem parameterized by constants INC, LIMIT, and RESET. The I/O for the model is Input and Output. The Amplifier subsystem amplifies the input signal by gain factor K, which is updated whenever signal equal to count is true.



Copyright 1994-2012 The MathWorks, Inc.

2. Open the Configuration Parameters dialog box from the model editor by clicking **Simulation > Configuration Parameters**.

Alternately, type the following commands at the MATLAB command prompt

```
cs = getActiveConfigSet(model);
openDialog(cs);
```

3. Select the **Code Generation** node.

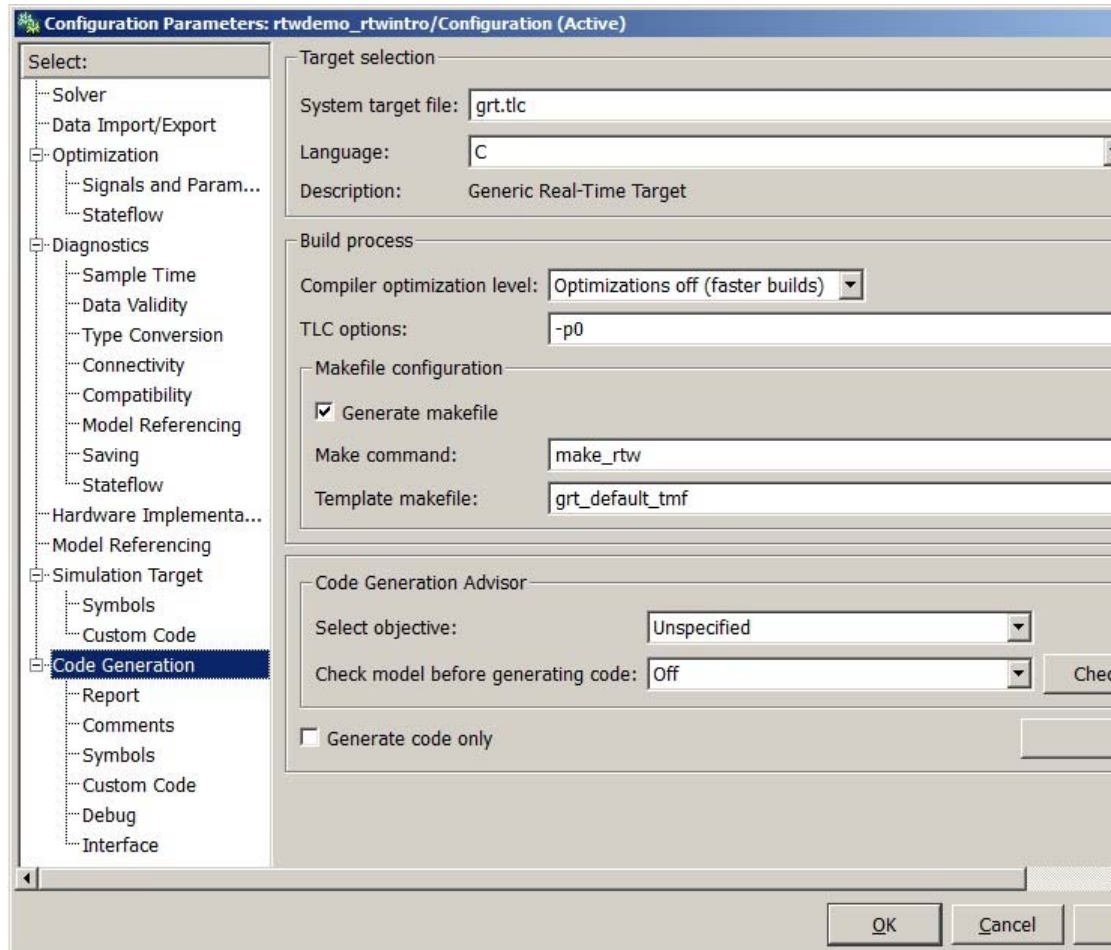

4. In the **Target Selection** pane, click **Browse** to select a target.

You can generate code for a particular target environment or purpose. Some built-in targeting options are provided using system target files, which control the code generation process for a target.

Target selection

System target file:

Language:

Description: Generic Real-Time Target

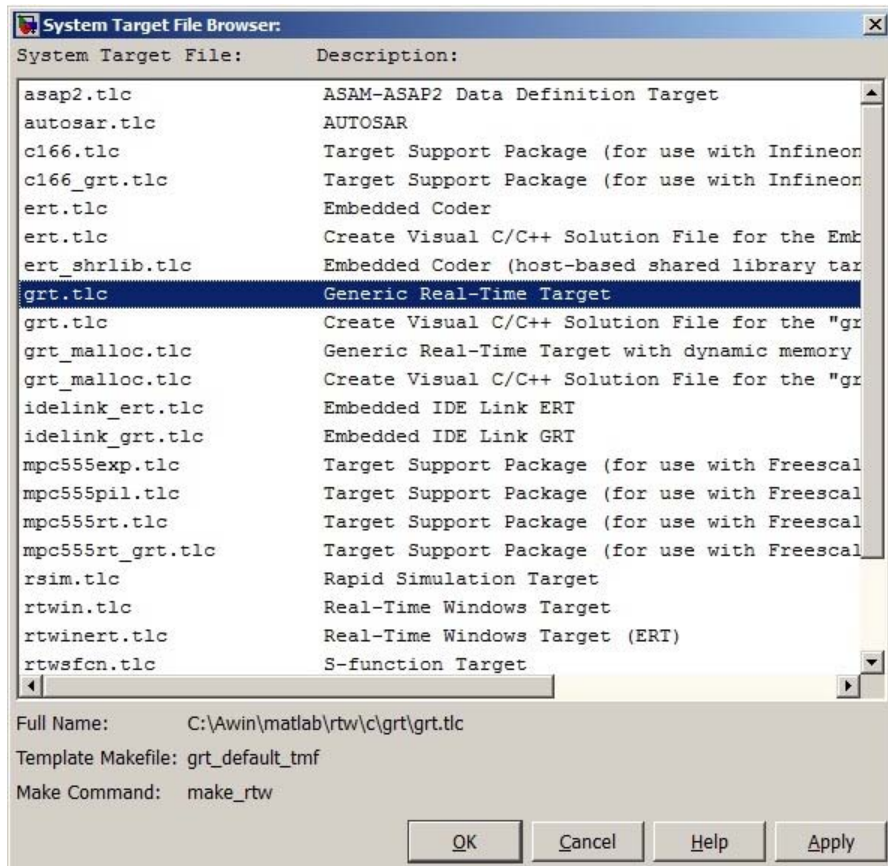

5. Select the **Generic Real-Time (GRT)** target and click **Apply**.

Optionally, in the **Code Generation Advisor** pane set the **Select objective** field to **Execution efficiency** or **Debugging**. Then click **Check model...** to identify and systematically change parameters to meet your objectives.

6. In the **Code Generation** pane, click **Build** to generate code.

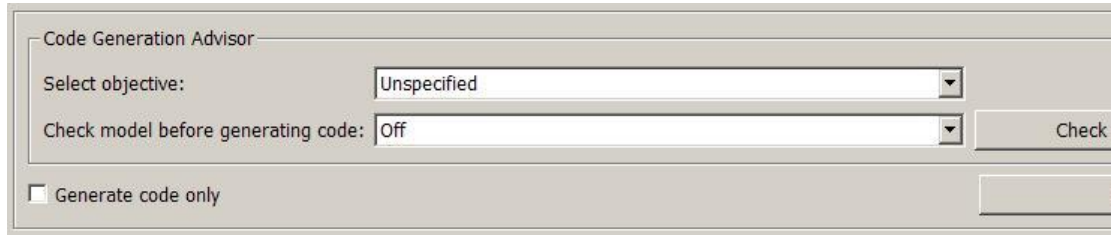

7. View the code generation report that appears.

The report includes links to model files such as `rtwdemo_rtwinintro.c` and associated utility and header files.

The screenshot displays the 'Code Generation Report' window. The title bar reads 'Code Generation Report'. At the top, there are 'Back' and 'Forward' buttons. The main content area is divided into two columns. The left column contains a 'Contents' section with 'Summary' highlighted in yellow, and a 'Generated Files' section with expandable categories: 'Model files' (expanded to show `rtwdemo_rtwintr0.c`, `rtwdemo_rtwintr0.h`, `rtwdemo_rtwintr0_private.h`, and `rtwdemo_rtwintr0_types.h`), 'Utility files (7)', 'Interface files (1)', and 'Other files (1)'. The right column features a large heading 'Code Generation Report for rtwdemo\_rtwintr0' and a 'Summary' section. The summary text includes: 'Code generation for model "rtwdemo\_rtwintr0.mdl".', 'Model version : 1.250', 'Simulink Coder version : 8.0 (R2011a) 27-Oct-2010', 'C source code generated on : Wed Nov 10 11:30:44 2010', 'Configuration settings at the time of code generation: [click to open](#)', 'Code generation objectives: **Unspecified**', and 'Validation result: Not run'.

The figure below contains a portion of `rtwdemo_rtwintr0.c`

```

Step function for model: rtwdemo_rtwintr
File: rtwdemo_rtwintr.c

1  /* Model step function */
2  void rtwdemo_rtwintr_step(void)
3  {
4      uint8_T rtb_sum_out;
5      boolean_T rtb_equal_to_count;
6
7      /* Sum: '<Root>/Sum' incorporates:
8       * Constant: '<Root>/INC'
9       * UnitDelay: '<Root>/X'
10     */
11     rtb_sum_out = (uint8_T)(1U + (uint32_T)rtwdemo_rtwintr_DWork.X);
12
13     /* RelationalOperator: '<Root>/RelOpt' incorporates:
14      * Constant: '<Root>/LIMIT'
15     */
16     rtb_equal_to_count = (rtb_sum_out != 16);
17
18     /* Outputs for Triggered SubSystem: '<Root>/Amplifier' incorporates:
19      * TriggerPort: '<S1>/Trigger'
20     */
21     if (rtb_equal_to_count && (rtwdemo_rtwintr_PrevZCSigState.Amplifier_Trig_ZCE
22      != POS_ZCSIG)) {
23         /* Outputport: '<Root>/Output' incorporates:
24          * Gain: '<S1>/Gain'
25          * Inport: '<Root>/Input'
26         */
27         rtwdemo_rtwintr_Y.Output = rtwdemo_rtwintr_U.Input << 1;
28     }
29
30     rtwdemo_rtwintr_PrevZCSigState.Amplifier_Trig_ZCE = (uint8_T)
31         (rtb_equal_to_count ? (int32_T)POS_ZCSIG : (int32_T)ZERO_ZCSIG);
32
33     /* End of Outputs for SubSystem: '<Root>/Amplifier' */
34
35     /* Switch: '<Root>/Switch' */
36     if (rtb_equal_to_count) {
37         /* Update for UnitDelay: '<Root>/X' */
38         rtwdemo_rtwintr_DWork.X = rtb_sum_out;
39     } else {
40         /* Update for UnitDelay: '<Root>/X' incorporates:
41          * Constant: '<Root>/RESET'
42         */
43         rtwdemo_rtwintr_DWork.X = 0U;
44     }
45
46     /* End of Switch: '<Root>/Switch' */
47 }

```



8. Close the model.

```
bdclose(model)  
rtwdemoclean;
```



# Report Generation

---

- “Reports for Code Generation” on page 11-2
- “HTML Code Generation Report Location” on page 11-3
- “HTML Code Generation Report for Referenced Models” on page 11-4
- “Generate a Code Generation Report” on page 11-5
- “Generate Code Generation Report After Build Process” on page 11-6
- “Open Code Generation Report” on page 11-8
- “Generate Code Generation Report Programmatically” on page 11-10
- “Search in the Code Generation Report” on page 11-11
- “View Code Generation Report in Model Explorer” on page 11-12
- “Package and Share the Code Generation Report” on page 11-14
- “Document Generated Code with Simulink® Report Generator™” on page 11-16

## Reports for Code Generation

Simulink Coder software provides an HTML code generation report so that you can view and analyze the generated code. When your model is built, the code generation process produces an HTML file that is displayed in an HTML browser or in the Model Explorer. The code generation report includes:

- The **Summary** section lists version, date, and code generation objectives information. The **Configuration settings at the time of code generation** link opens a noneditable view of the Configuration Parameters dialog box. The dialog box shows the Simulink model settings at the time of code generation, including TLC options.
- The **Subsystem Report** section contains information on nonvirtual subsystems in the model.
- In the **Generated Files** section on the **Contents** pane, you can click the names of source code files generated from your model to view their contents in a MATLAB Web browser window. In the displayed source code, global variables are hypertext that links to their definitions.
- A **Search** box in the left navigation pane. For more information, see “Search in the Code Generation Report” on page 11-11.

For an example, see “Generate a Code Generation Report” on page 11-5 and “View Code Generation Report in Model Explorer” on page 11-12.

The contents of HTML reports varies depending on different target types. You can generate individual HTML reports for a subsystem or referenced model. For more information, see “HTML Code Generation Report for Referenced Models” on page 11-4 and “Generate Code for Referenced Models” on page 3-4.

If you have a Simulink Report Generator license, you can document your code generation project in multiple formats, including HTML, PDF, RTF, Microsoft Word, and XML. For an example of how to create a Microsoft Word report, see “Document Generated Code with Simulink® Report Generator™” on page 11-16.

## HTML Code Generation Report Location

The default location for the code generation report files is in the `html` subfolder of the build folder, `model_target_rtw/html/`. *target* is the name of the **System target file** specified on the **Code Generation** pane. The default name for the top-level HTML report file is `model_codegen_rpt.html` or `subsystem_codegen_rpt.html`. For more information on the location of the build folder, see “Control the Location for Generated Files” on page 5-18.

## HTML Code Generation Report for Referenced Models

To generate a code generation report for a top model and code generation reports for each referenced model, you need to specify the **Create code generation report** on the **Code Generation > Report** pane for the top model and each referenced model. You can open the code generation report of a referenced model in one of two ways:

- From the top-model code generation report, you can access the referenced model code generation report by clicking a link under **Referenced Models** in the left navigation pane. Clicking a link opens the code generation report for the referenced model in the browser. To navigate back to the top model code generation report, use the **Back** button at the top of the left navigation pane.
- From the referenced model diagram window, select **Code > C/C++ Code > Code Generation Report > Open Model Report**.

To generate a code generation report for a referenced model individually, follow the instructions in “Generate a Code Generation Report” on page 11-5 and “Open Code Generation Report” on page 11-8 for the referenced model.

## Generate a Code Generation Report

To generate a code generation report when the model is built:

- 1** In the model diagram window, select **Code > C/C++ Code > Code Generation Report > Options**. The Configuration Parameters dialog box opens with the **Code Generation > Report** pane visible.
- 2** Select the **Create code generation report** parameter.
- 3** If you want the code generation report to automatically open after generating code, select the **Open report automatically** parameter (which is enabled by selecting **Create code generation report**).
- 4** Generate code.

The build process writes the code generation report files to the `html` subfolder of the build folder (see “HTML Code Generation Report Location” on page 11-3). Next, the build process automatically opens a MATLAB Web browser window and displays the code generation report.

To open an HTML code generation report at any time after a build, see “Open Code Generation Report” on page 11-8 and “Generate Code Generation Report After Build Process” on page 11-6.

## Generate Code Generation Report After Build Process

After generating code, if you did not configure your model to create a code generation report, you can generate a code generation report without rebuilding your model.

- 1 In the model diagram window, select **Code > C/C++ Code > Code Generation Report > Open Model Report**.
- 2 If your current working folder contains the code generation files the following dialog opens.

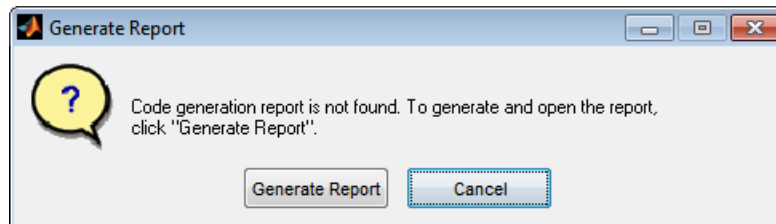

Click **Generate Report**.

- 3 If the code generation files are not in your current working directory, the following dialog opens.

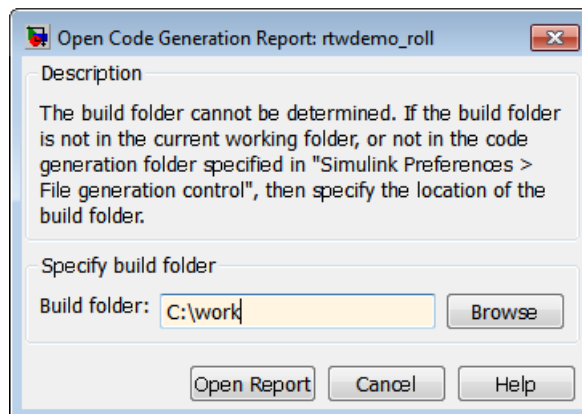

Enter the full path of the build folder for your model, `../model_target_rtw` and click **Open Report**.



The software generates a report from the code generation files in the build folder you specified.

---

**Note** An alternative method for generating the report after the build process is complete is to configure your model to generate a report and build your model. In this case, Embedded Coder generates the report without regenerating the code.

---

## Open Code Generation Report

You can refer to existing code generation reports at any time. If you generated a code generation report, you can open the report by selecting **Code > C/C++ Code > Code Generation Report > Open Model Report**. If you are opening a report for a subsystem, select **Open Subsystem Report**.

If your current working folder does not contain the code generation files and the code generation report, the following dialog opens:

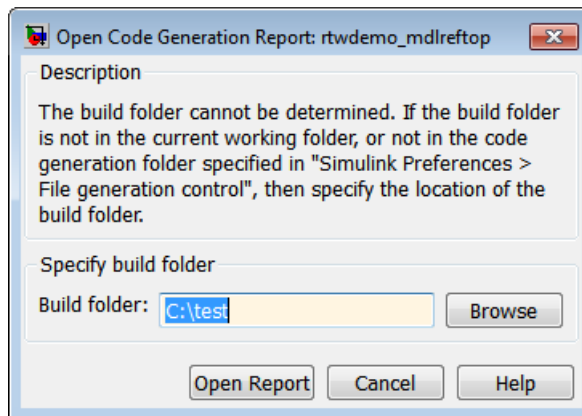

Enter the full path of the build folder for your model, `../model_target_rtw` and click **Open Report**.

Alternatively, you can open the code generation report (`model_codegen_rpt.html` or `subsystem_codegen_rpt.html`) manually into a MATLAB Web browser window, or into another Web browser. For the location of the generated report files, see “HTML Code Generation Report Location” on page 11-3.

### Limitation

If you modify legacy or custom code after building your model or generating the code generation report, you must rebuild your model or regenerate the report for the code generation report to include the updated legacy source files. For example, if you modify your legacy code and then use the **Code > C/C++ Code > Code Generation Report > Open Model Report** menu to open an existing report, the software does not check if the legacy source file is

out of date compared to the generated code. Therefore, the code generation report is not regenerated and the report includes the out-of-date legacy code. This issue also occurs if you open a code generation report using the `coder.report.open` function.

To regenerate the code generation report, do one of the following:

- Rebuild your model.
- Generate the report using the `coder.report.generate` function.

# Generate Code Generation Report Programmatically

At the MATLAB command line, you can generate, open, and close an HTML Code Generation Report with the following functions:

- `coder.report.generate` generates the code generation report for the specified model.
- `coder.report.open` opens an existing code generation report.
- `coder.report.close` closes the code generation report.

## Search in the Code Generation Report

When the code generation report is displayed in the MATLAB Web browser window, you can search the report using the **Search** box in the left navigation pane. The search is not case sensitive.

Pressing **Ctrl-F** sets focus to the **Search** box. Type text into the **Search** box and hit **Enter** to start the search. The search highlights any found terms in the displayed page and scrolls to the first instance found. Press **Enter** to scroll through the subsequent search hits. If no terms are found, the background of the search box is highlighted red.

## View Code Generation Report in Model Explorer

After generating an HTML code generation report, you can view the report in the right pane of the Model Explorer. You can also browse the generated files directly in the Model Explorer.

When you generate code, or open a model that has generated code for its current target configuration in your working folder, the **Hierarchy** (left) pane of Model Explorer contains a node named **Code for model1**. Under that node are other nodes, typically called **This Model** and **Shared Code**. Clicking **This Model** displays in the **Contents** (middle) pane a list of generated source code files in the build folder of that model. The next figure shows code for the `rtwdemo_counter` model.

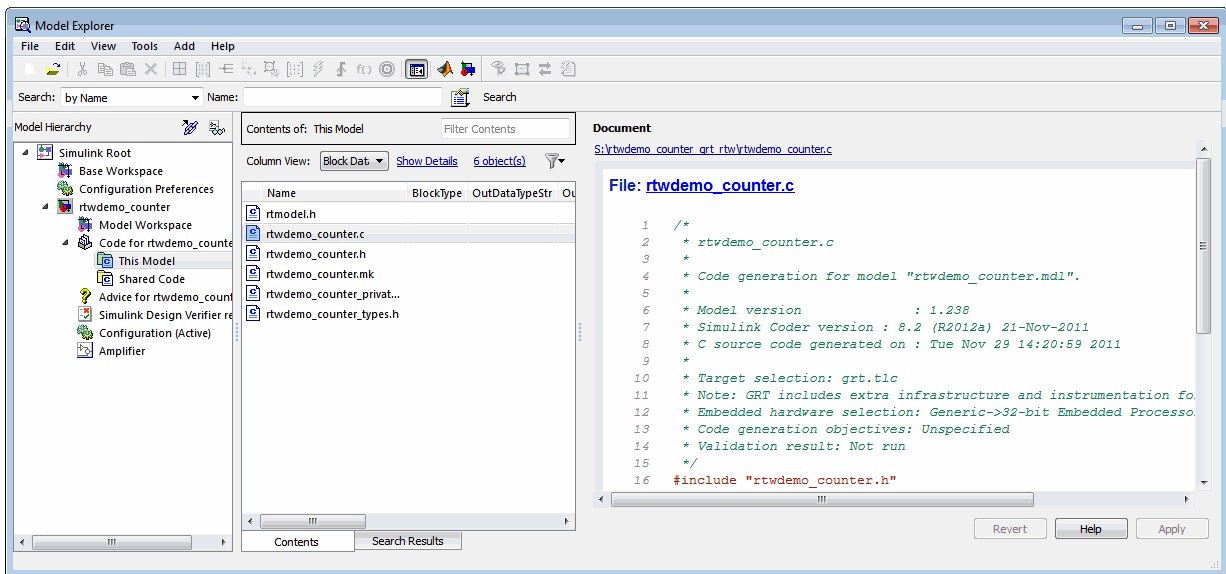

In this example, the file `S:/rtwdemo_counter_grt_rtw/rtwdemo_counter.c` is being displayed. To view any file in the **Contents** pane, click it once.

The views in the **Document** (right) pane are read only. The code listings there contain hyperlinks to functions and macros in the generated code. Clicking the file hyperlink opens that source file in a text editing window where you can modify its contents.

If an open model contains Model blocks, and if generated code for any of these models exists in the current `slprj` folder, nodes for the referenced models appear in the **Hierarchy** pane one level below the node for the top model. Such referenced models do not need to be open for you to browse and read their generated source files.

If the Simulink Coder software generates shared utility code for a model, a node named **Shared Code** appears directly under the **This Model** node. It collects any source files that exist in the `./slprj/target/_sharedutils` subfolder.

---

**Note** You cannot use the **Search** tool built into Model Explorer toolbar to search generated code displayed in the Code Viewer. On PCs, typing **Ctrl+F** when focused on the **Document** pane opens a Find dialog box that you can use to search for strings in the currently displayed file. You can also search for text in the HTML report window, and you can open any of the files in the editor.

---

## Package and Share the Code Generation Report

### In this section...

“Package the Code Generation Report” on page 11-14

“View the Code Generation Report” on page 11-15

### Package the Code Generation Report

To share the code generation report, you can package the code generation report files and supporting files into a zip file for transfer. The default location for the code generation report files is in two folders:

- /slprj
- html subfolder of the build folder, *model\_target\_rtw*, for example *rtwdemo\_counter\_grt\_rtw/html*

To create a zip file from the MATLAB command window:

**1** In the Current Folder browser, select the two folders:

- /slprj
- Build folder: *model\_target\_rtw*

**2** Right-click to open the context menu.

**3** In the context menu, select **Create Zip File**. A file appears in the Current Folder browser.

**4** Name the zip file.

Alternatively, you can use the MATLAB zip command to zip the code generation report files:

```
zip('myzip',{'slprj','rtwdemo_counter_grt_rtw'})
```



---

**Note** If you need to relocate the static and generated code files for a model to another development environment, such as a system or an integrated development environment (IDE) that does not include MATLAB and Simulink products, use the Simulink Coder pack-and-go utility. For more information, see “Relocate Code to Another Development Environment” on page 15-33.

---

## **View the Code Generation Report**

To view the code generation report after transfer, unzip the file and save the two folders at the same folder level in the hierarchy. Navigate to the *model\_target\_rtw/html/* folder and open the top-level HTML report file named *model\_codgen\_rpt.html* or *subsystem\_codegen\_rpt.html* in a Web browser.

## Document Generated Code with Simulink Report Generator

### In this section...

“Generate Code for the Model” on page 11-17

“Open the Report Generator” on page 11-18

“Set Report Name, Location, and Format” on page 11-20

“Include Models and Subsystems in a Report” on page 11-21

“Customize the Report” on page 11-22

“Generate the Report” on page 11-23

The Simulink Report Generator software creates documentation from your model in multiple formats, including HTML, PDF, RTF, Microsoft Word, and XML. This example shows one way to document a code generation project in Microsoft Word. The generated report includes:

- System snapshots (model and subsystem diagrams)
- Block execution order list
- Simulink Coder and model version information for generated code
- List of generated files
- Optimization configuration parameter settings
- Simulink Coder target selection and build process configuration parameter settings
- Subsystem map
- File name, path, and generated code listings for the source code

To adjust Simulink Report Generator settings to include custom code and then generate a report for a model, complete the following tasks:

- 1** “Generate Code for the Model” on page 11-17
- 2** “Open the Report Generator” on page 11-18

- 3 “Set Report Name, Location, and Format” on page 11-20
- 4 “Include Models and Subsystems in a Report” on page 11-21
- 5 “Customize the Report” on page 11-22
- 6 “Generate the Report” on page 11-23

For more information on generating other reports, see the Simulink Report Generator User Guide.

## Generate Code for the Model

Before you use the Report Generator to document your project, generate code for the model.

- 1 In the MATLAB Current Folder browser, navigate to a folder where you have write access.
- 2 Create a working folder from the MATLAB command line by typing:  

```
mkdir report_ex
```
- 3 Make `report_ex` your working folder:  

```
cd report_ex
```
- 4 Open the `sldemo_f14` model by clicking the following model name below or by entering the model name on the MATLAB command line.
- 5 In the model window, choose **File > Save As**, navigate to the working folder, `report_ex`, and save a copy of the `sldemo_f14` model as `myf14`.
- 6 Open the Model Explorer by selecting **Model Explorer** from the model **View** menu.
- 7 In the **Model Hierarchy** pane, click the expander for the model name to reveal its components.
- 8 In the left pane, click **Configuration (Active)**.

- 9 Select the **Solver** tab. In the **Solver options** section, specify the **Type** parameter as **Fixed-step**.
- 10 Select the **General** tab. Select **Generate code only**. Scroll down if the configuration parameter is not visible.
- 11 Click **Apply**.
- 12 Click **Generate code**. The Simulink Coder build process generates code for the model.

### **Open the Report Generator**

After you generate the code, open the Report Generator.

- 1 In the model diagram window, select **Tools > Report Generator**.

- 2 In the Report Explorer window, in the options pane (center), click the folder **rtw** (\toolbox\rtw). Click the setup file that it contains, **codegen.rpt**.

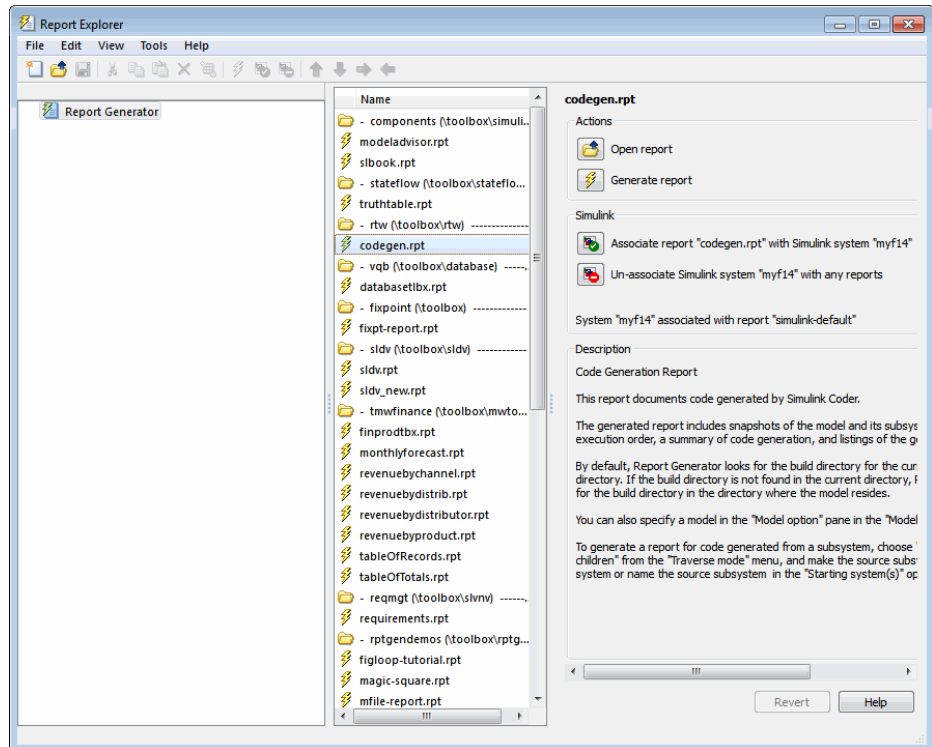

- 3 Double-click **codegen.rpt** or select it and click the **Open report** button



The Report Explorer displays the structure of the setup file in the outline pane (left).

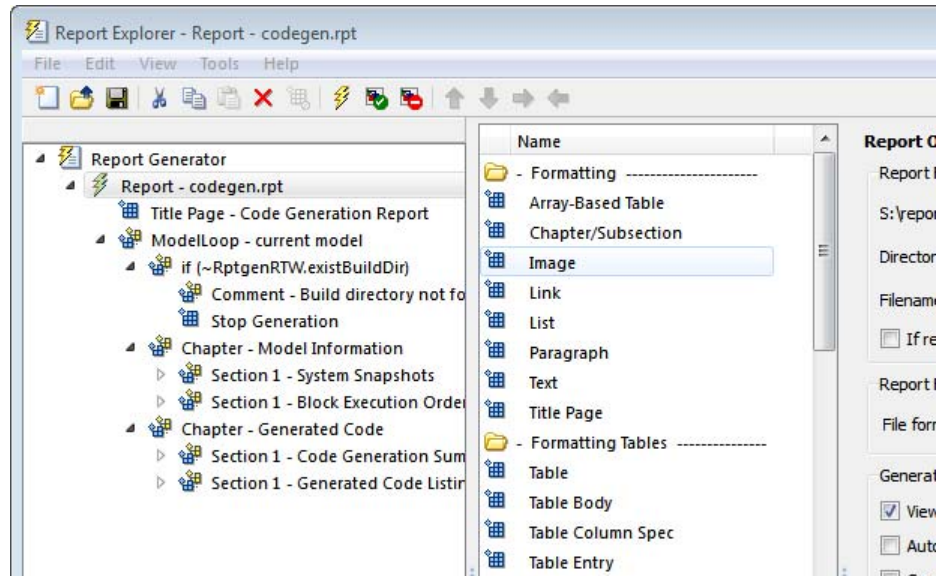

## Set Report Name, Location, and Format

Before generating a report, you can specify report output options, such as the folder, file name, and format. For example, to generate a Microsoft Word report named `MyCGModelReport.rtf`:

- 1 In the properties pane, under **Report Options**, review the options listed.

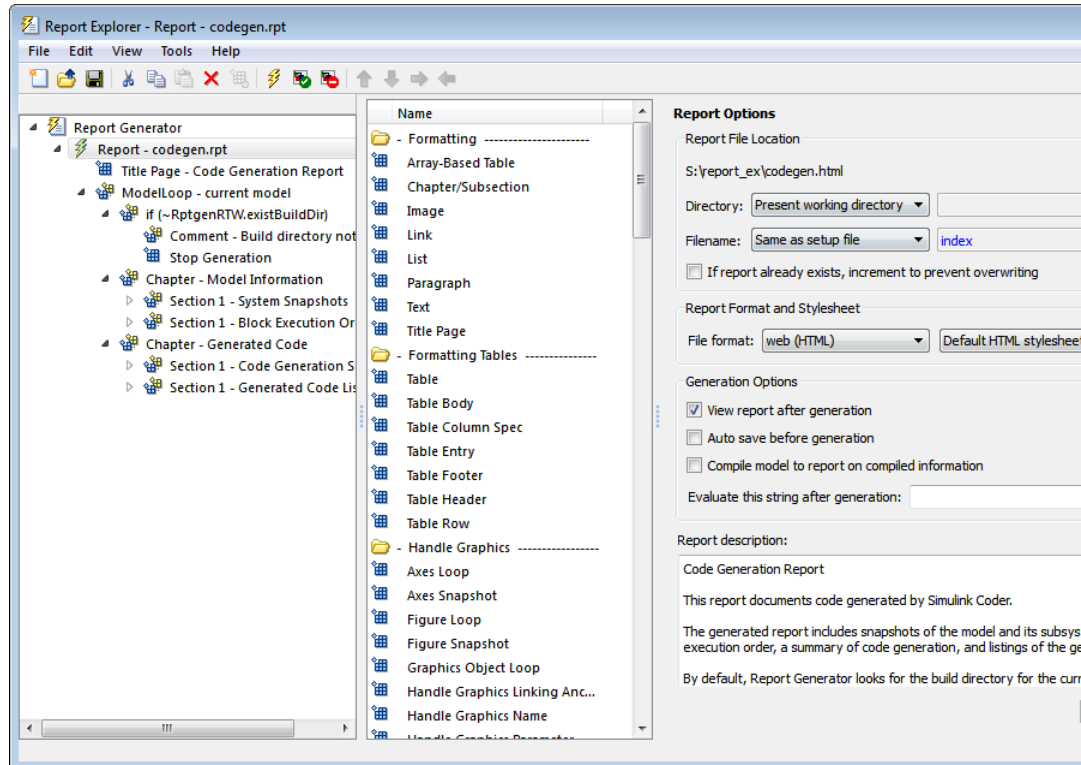

- 2 Leave the **Directory** field set to Present working directory.
- 3 For **Filename**, select Custom: and replace index with the name MyModelCGReport.
- 4 For **File format**, specify Rich Text Format and replace Standard Print with Numbered Chapters & Sections.

## Include Models and Subsystems in a Report

Specify the models and subsystems that you want to include in the generated report by setting options in the Model Loop component.

- 1 In the outline pane (left), select **Model Loop**. Report Generator displays Model Loop component options in the properties pane.
- 2 If not already selected, select **Current** block diagram for the **Model name** option.
- 3 In the outline pane, click **Report - codegen.rpt\***.

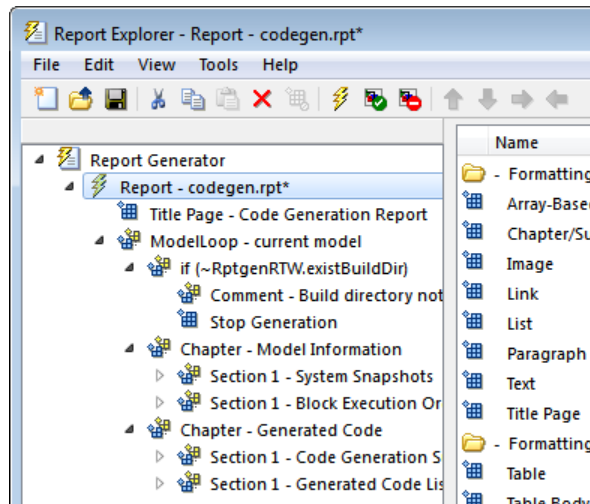

## Customize the Report

After specifying the models and subsystems to include in the report, you can customize the sections included in the report.

- 1 In the outline pane (left), expand the node **Chapter - Generated Code**. By default, the report includes two sections, each containing one of two report components.
- 2 Expand the node **Section 1 — Code Generation Summary**.
- 3 Select **Code Generation Summary**. Options for the component are displayed in the properties pane.



- 4 Click **Help** to review the report customizations that you can make with the Code Generation Summary component. For this example, do not customize the component.
- 5 In the Report Explorer window, expand the node **Section 1 — Generated Code Listing**.
- 6 Select **Import Generated Code**. Options for the component are displayed in the properties pane.
- 7 Click **Help** to review the report customizations that you can make with the Import Generated Code component.

## Generate the Report

After you adjust the report options, from the **Report Explorer** window, generate the report by clicking **File > Report**. A **Message List** dialog box opens, which displays messages that you can monitor as the report is generated. Model snapshots also appear during report generation. The **Message List** dialog box might be hidden behind other dialog boxes.

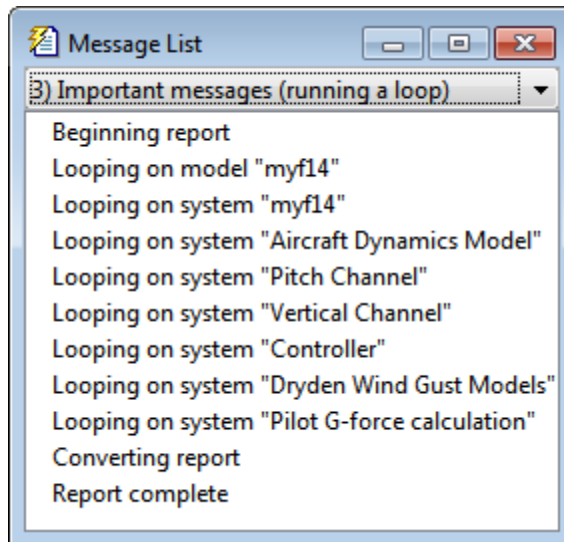

When the report is complete, open the report, `MyModelCGReport.rtf` in the folder `report_ex` (in this example).

For alternative ways of generating reports with the Simulink Report Generator, see “Report Generation”.

# Deployment

---

- Chapter 12, “Desktops”
- Chapter 13, “Real-Time Systems”
- Chapter 14, “External Code Integration”
- Chapter 15, “Program Building, Interaction, and Debugging”



# Desktops

---

- “Rapid Simulations” on page 12-2
- “Generated S-Function Block” on page 12-34

## Rapid Simulations

### In this section...

- “About Rapid Simulation” on page 12-2
- “Rapid Simulation Performance” on page 12-3
- “General Rapid Simulation Workflow” on page 12-3
- “Identify Rapid Simulation Requirements” on page 12-4
- “Configure Inports to Provide Simulation Source Data” on page 12-6
- “Configure and Build Model for Rapid Simulation” on page 12-6
- “Set Up Rapid Simulation Input Data” on page 12-9
- “Scripts for Batch and Monte Carlo Simulations” on page 12-19
- “Run Rapid Simulations” on page 12-20
- “Rapid Simulation Target Limitations” on page 12-33

### About Rapid Simulation

After you create a model, you can use the Simulink Coder rapid simulation (RSim) target to characterize the model behavior. The RSim target executable that results from the build process is for non-real-time execution on your host computer. The executable is highly optimized for simulating models of hybrid dynamic systems, including models that use variable-step solvers and zero-crossing detection. The speed of the generated code makes the RSim target ideal for batch or Monte Carlo simulations.

Use the RSim target to generate an executable that runs fast, standalone simulations. You can repeat simulations with varying data sets, interactively or programmatically with scripts, without rebuilding the model. This can accelerate the characterization and tuning of model behavior and code generation testing.

Using command-line options:

- Define parameter values and input signals in one or more MAT-files that you can load and reload at the start of simulations without rebuilding your model.

- Redirect logging data to one or more MAT-files that you can then analyze and compare.
- Control simulation time.
- Specify External mode options.

---

**Note** To run an RSim executable, configure your computer to run MATLAB and have the MATLAB and Simulink installation folders accessible. To deploy a standalone host executable ( i.e., without MATLAB and Simulink installed), consider using the Host-Based Shared Library target (ert\_shrlib)."

---

## Rapid Simulation Performance

The performance advantage that you gain from rapid simulation varies. Larger simulations achieve speed improvements of up to 10 times faster than standard Simulink simulations. Some models might not show any noticeable improvement in simulation speed. To determine the speed difference for your model, time your standard Simulink simulation and compare the results with a rapid simulation. In addition, test the model performance in Rapid Accelerator simulation mode.

## General Rapid Simulation Workflow

Like other stages of Model-Based Design, characterization and tuning of model behavior is an iterative process, as shown in the general workflow diagram in the figure. Tasks in the workflow are:

- 1** Identify your rapid simulation requirements.
- 2** Configure Inport blocks that provide input source data for rapid simulations.
- 3** Configure the model for rapid simulation.
- 4** Set up simulation input data.
- 5** Run the rapid simulations.

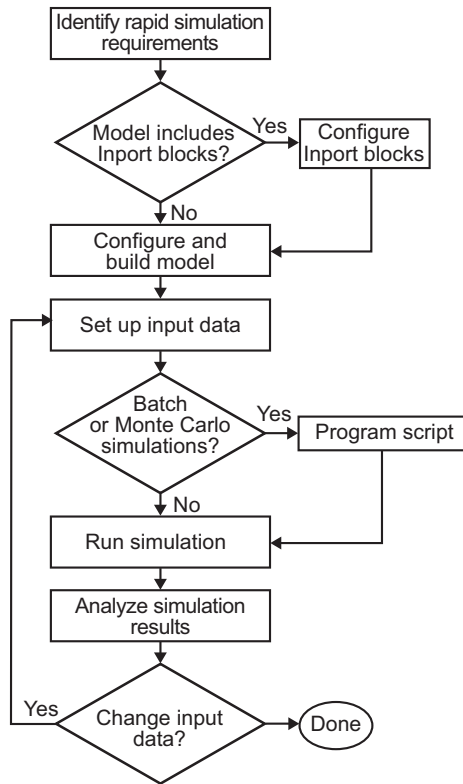

## Identify Rapid Simulation Requirements

The first step to setting up a rapid simulation is to identify your simulation requirements.

Question...	For More Information, See...
How long do you want simulations to run?	“Configure and Build Model for Rapid Simulation” on page 12-6
Are there any solver requirements? Do you expect to use the same solver for which the model is configured for your rapid simulations?	“Configure and Build Model for Rapid Simulation” on page 12-6



Question...	For More Information, See...
Do your rapid simulations need to accommodate flexible custom code interfacing? Or, do your simulations need to retain storage class settings?	“Configure and Build Model for Rapid Simulation” on page 12-6
Will you be running simulations with multiple data sets?	“Set Up Rapid Simulation Input Data” on page 12-9
Will the input data consist of global parameters, signals, or both?	“Set Up Rapid Simulation Input Data” on page 12-9
What type of source blocks provide input data to the model — From File, Inport, From Workspace?	“Set Up Rapid Simulation Input Data” on page 12-9
Will the model’s parameter vector ( <i>model_P</i> ) be used as input data?	“Create a MAT-File That Includes a Model Parameter Structure” on page 12-10
What is the data type of the input parameters and signals?	“Set Up Rapid Simulation Input Data” on page 12-9
Will the source data consist of one variable or multiple variables?	“Set Up Rapid Simulation Input Data” on page 12-9
Does the input data include tunable parameters?	“Create a MAT-File That Includes a Model Parameter Structure” on page 12-10
Do you need to gain access to tunable parameter information — model checksum and parameter data types, identifiers, and complexity?	“Create a MAT-File That Includes a Model Parameter Structure” on page 12-10
Will you have a need to vary the simulation stop time for simulation runs?	“Configure and Build Model for Rapid Simulation” on page 12-6 and “Override a Model Simulation Stop Time” on page 12-23
Do you want to set a time limit for the simulation? Consider setting a time limit if your model experiences frequent zero crossings and has a small minor step size.	“Set a Clock Time Limit for a Rapid Simulation” on page 12-23

Question...	For More Information, See...
Do you need to preserve the output of each simulation run?	“Specify a New Output File Name for a Simulation” on page 12-32 and “Specify New Output File Names for To File Blocks” on page 12-33
Do you expect to run the simulations interactively or in batch mode?	“Scripts for Batch and Monte Carlo Simulations” on page 12-19

## Configure Inports to Provide Simulation Source Data

You can use Inport blocks as a source of input data for rapid simulations. To do so, configure the blocks so that they can import data from external MAT-files. By default, the Inport block inherits parameter settings from downstream blocks. In most cases, to import data from an external MAT-file, you must explicitly set the following parameters to match the source data in the MAT-file.

- **Main > Interpolate data**
- **Signal Attributes > Port dimensions**
- **Signal Attributes > Data type**
- **Signal Attributes > Signal type**

If you do not have control over the model content, you might need to modify the data in the MAT-file to conform to what the model expects for input. Input data characteristics and specifications of the Inport block that receives the data must match.

For details on adjusting these parameters and on creating a MAT-file for use with an Inport block, see “Create a MAT-File for an Inport Block” on page 12-15. For descriptions of the preceding block parameters, see the description of the Inport block in the Simulink documentation.

## Configure and Build Model for Rapid Simulation

After you identify your rapid simulation requirements, configure the model for rapid simulation.

- 1 Open the Configuration Parameters dialog box.

- 2 Go to the **Code Generation** pane.
- 3 On the **Code Generation** pane, click **Browse**. The System Target File Browser opens.
- 4 Select `rsim.tlc` (Rapid Simulation Target) and click **OK**.

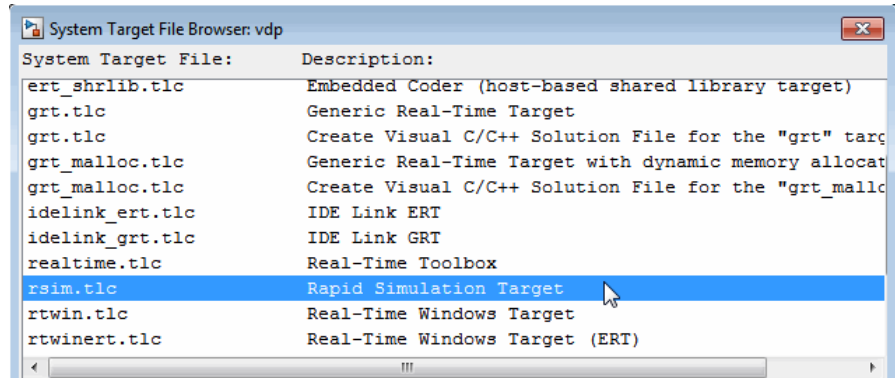

On the **Code Generation** pane, the Simulink Coder software populates the **Make command** and **Template makefile** fields with default settings and adds the **RSim Target** pane under **Code Generation**.

- 5 Click **RSim Target** to view the **RSim Target** pane.

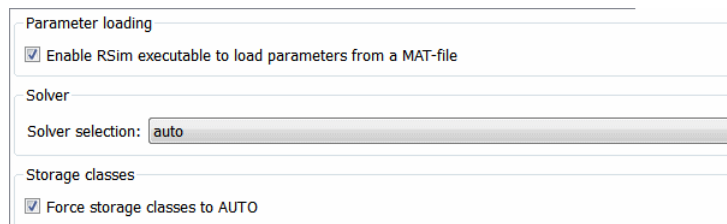

- 6 Set the RSim target configuration parameters to your rapid simulation requirements.

If You Want to...	Then...
Generate code that allows the RSim executable to load parameters from a MAT-file	Select <b>Enable RSim executable to load parameters from a MAT-file</b> (default).
Let the target choose a solver based on the solver already configured for the model.	Set <b>Solver selection</b> to auto (default). The Simulink Coder software uses a built-in solver if a fixed-step solver is specified on the <b>Solver</b> pane or calls the Simulink solver module (a shared library) if a variable-step solver is specified.
Explicitly instruct the target to use a fixed-step solver	Set <b>Solver selection</b> to Use fixed-step solvers. In the Configuration Parameters dialog box, on the <b>Solver</b> pane, specify a fixed-step solver.
Explicitly instruct the target to use a variable-step solver	Set <b>Solver selection</b> to Use Simulink solver module. In the Configuration Parameters dialog box, on the <b>Solver</b> pane, specify a variable-step solver.
Force all storage classes to Auto for flexible custom code interfacing	Select <b>Force storage classes to AUTO</b> (default).
Retain storage class settings, such as ExportedGlobal or ImportedExtern, due to application requirements	Clear <b>Force storage classes to AUTO</b> .

- 7 Set up data import and export options. On the **Data Import/Export** pane, in the **Save to Workspace** section, select the **Time**, **States**, **Outputs**, and **Final States** options, as they apply. By default, the Simulink Coder software saves simulation logging results to a file named *model.mat*. For more information, see “Export Simulation Data”.
- 8 If you are using External mode communications, set up the interface, using the **Code Generation > Interface** pane. See “Host/Target Communication” on page 15-50 for details.
- 9 Return to the **Code Generation** pane and click **Build**. The Simulink Coder code generator builds a highly optimized executable that you can run on your host computer with varying data, without rebuilding.

For more information on compilers that are compatible with the Simulink Coder product, see “Choose and Configure a Compiler” on page 15-2 and “Template Makefiles and Make Options” on page 9-38 .

## Set Up Rapid Simulation Input Data

- “About Rapid Simulation Data Setup” on page 12-9
- “Create a MAT-File That Includes a Model Parameter Structure” on page 12-10
- “Create a MAT-File for a From File Block” on page 12-14
- “Create a MAT-File for an Inport Block” on page 12-15

### About Rapid Simulation Data Setup

The format and setup of input data for a rapid simulation depends on your requirements.

If the Input Data Source Is...	Then...
The model’s global parameter vector ( <i>model_P</i> )	Use the <code>rsimgetrtp</code> function to get the vector content and then save it to a MAT-file.
The model’s global parameter vector and you want a mapping between the vector and tunable parameters	In the Configuration Parameters dialog box, on the <b>Optimization &gt; Signals and Parameters</b> pane, enable the <b>Inline Parameters</b> option. Call the <code>rsimgetrtp</code> function to get the global parameter structure and then save it to a MAT-file.
Provided by a From File block	Create a MAT-file that a From File block can read.
Provided by an Inport block	Create a MAT-file that adheres to one of the three data file formats that the Inport block can read.
Provided by a From Workspace block	Create structure variables in the MATLAB workspace.

The RSim target requires that MAT-files used as input for From File and Inport blocks contain data. The grt target inserts MAT-file data directly into the generated code, which is then compiled and linked as an executable. In contrast, RSim allows you to replace data sets for each successive simulation. A MAT-file containing From File or Inport block data must be present if a From File block or Inport block exists in your model.

### Create a MAT-File That Includes a Model Parameter Structure

To create a MAT-file that includes a model global parameter structure (*model\_P*),

- 1 Get the structure by calling the function `rsimgetrtp`.
- 2 Save the parameter structure to a MAT-file.

If you want to run simulations over varying data sets, consider converting the parameter structure to a cell array and saving the parameter variations to a single MAT-file.

**Get the Parameter Structure for a Model.** Get the global parameter structure (*model\_P*) for a model by calling the function `rsimgetrtp`.

```
param_struct = rsimgetrtp('model')
```

Argument	Description
<i>model</i>	The model for which you are running the rapid simulations.

The `rsimgetrtp` function forces an update diagram action for the specified model and returns a structure that contains the following fields.

Field	Description
modelChecksum	A four-element vector that encodes the structure of the model. The Simulink Coder software uses the checksum to check whether the structure of the model has changed since the RSim executable was generated. If you delete or add a block, and then generate a new <i>model_P</i> vector, the new checksum no longer matches the original checksum. The RSim executable detects this incompatibility in parameter vectors and exits to avoid returning incorrect simulation results. If the model structure changes, you must regenerate the code for the model.
parameters	A structure that contains the model's global parameters.

The parameter structure contains the following information.

Field	Description
dataTypeName	The name of the parameter data type, for example, <code>double</code>
dataTypeID	Internal data type identifier used by the Simulink Coder software
complex	The value 0 if real; 1 if complex
dtTransIdx	Internal data index used by Simulink Coder software
values	A vector of the parameter values associated with this structure
map	If you select the <b>Inline parameters</b> option, this field contains the mapping information that correlates the 'values' to the tunable parameters of the model. This mapping information, in conjunction with <code>rsimsetrtpparam</code> , is useful for creating subsequent <code>rtP</code> structures without compiling the block diagram.

If you select the **Inline parameters** option for the model, then tunable parameter information is also available in the `parameters` field.

The Simulink Coder software reports a tunable fixed-point parameter according to its stored value. For example, an `sfix(16)` parameter value of 1.4 with a scaling of  $2^{-8}$  has a value of 358 as an `int16`.

In the following example, `rsimgetrtp` returns the parameter structure for the example model `rtwdemo_rsimtf` to `param_struct`.

```
param_struct = rsimgetrtp('rtwdemo_rsimtf')

param_struct =

    mode1Checksum: [1.7165e+009 3.0726e+009 2.6061e+009 2.3064e+009]
    parameters: [1x1 struct]
```

**Save the Parameter Structure to a MAT-File.** After you issue a call to `rsimgetrtp`, save the return value of the function call to a MAT-file. Using a command-line option, you can then specify that MAT-file as input for rapid simulations.

The following example saves the parameter structure returned for `rtwdemo_rsimtf` to the MAT-file `myrsimdemo.mat`.

```
save myrsimdemo.mat param_struct;
```

For information on using command-line options to specify required files, see “Run Rapid Simulations” on page 12-20.

**Convert the Parameter Structure for Running Simulations on Varying Data Sets.** If you need to use rapid simulations to test changes to specific parameters, you can convert the model parameter structure to a cell array. You can then access a specific parameter by using the `@` operator to specify the index for a specific parameter in the file.

To convert the structure to a cell array:

- 1 Save the `parameters` vector of the structure returned by `rsimgetrtp` to a temporary variable. The following example saves the parameter vector to temporary variable `p`.

```
param_struct = rsimgetrtp('rtwdemo_rsimtf');
p = param_struct.parameters;
```



- 2 Convert the structure to a cell array.

```
param_struct.parameters = [];
```

- 3 Assign the saved contents of the temporary variable to the original structure name as an element of the cell array.

```
param_struct.parameters{1} = p;  
param_struct.parameters{1}
```

```
ans =
```

```
    dataTypeName: 'double'  
    dataTypeId: 0  
    complex: 0  
    dtTransIdx: 0  
    values: [-140 -4900 0 4900]  
map: []
```

- 4 Make a copy of the cell array to preserve the original parameter values.

```
param_struct.parameters{2} = param_struct.parameters{1};  
param_struct.parameters{2}
```

```
ans =
```

```
    dataTypeName: 'double'  
    dataTypeId: 0  
    complex: 0  
    dtTransIdx: 0  
    values: [-140 -4900 0 4900]  
map: []
```

For a subsequent data set, increment the array index.

- 5 Modify any combination of the parameter values.

```
param_struct.parameters{2}.values=[ -150 -5000 0 4950];
```

- 6 Repeat steps 4 and 5 for each parameter data set that you want to use as input to a rapid simulation of the model.

- 7 Save the cell array representing the parameter structure to a MAT-file.

```
save rtwdemo_rsimtf.mat param_struct;
```

For more information on how to specify each data set when you run the simulations, see “Change Block Parameters for an RSim Simulation” on page 12-30.

### **Create a MAT-File for a From File Block**

You can use a MAT-file as the input data source for a From File block. The format of the data in the MAT-file must match the data format expected by that block.

To create a MAT-file for a From File block:

- 1 For array format data, in the workspace create a matrix that consists of two or more rows. The first row must contain monotonically increasing time points. Other rows contain data points that correspond to the time point in that column. The time and data points must be data of type double.

For example:

```
t=[0:0.1:2*pi]';  
Ina1=[2*sin(t) 2*cos(t)];  
Ina2=sin(2*t);  
Ina3=[0.5*sin(3*t) 0.5*cos(3*t)];  
var_matrix=[t Ina1 Ina2 Ina3]';
```

For other supported data types, such as int16 or fixed-point, the time data points must be of type double, just as for array format data. However, the sample data can be of any dimension.

For more information on setting up the input data, see the description of the From File block in the Simulink documentation.

- 2 Save the matrix to a MAT-file.

The following example saves the matrix `var_matrix` to the MAT-file `myrsimdemo.mat` in Version 7.3 format.

```
save '-v7.3' myrsimdemo.mat var_matrix;
```

Using a command-line option, you can then specify that MAT-file as input for rapid simulations.

## Create a MAT-File for an Inport Block

You can use a MAT-file as the input data source for an Inport block.

The format of the data in the MAT-file must adhere to one of the three column-based formats listed in the following table. The table lists the formats in order from least flexible to most flexible.

Format	Description
Single time/data matrix	<ul style="list-style-type: none"> <li>• Least flexible.</li> <li>• One variable.</li> <li>• Two or more <i>columns</i>. Number of columns must equal the sum of the dimensions of all root Inport blocks plus 1. First column must contain monotonically increasing time points. Other columns contain data points that correspond to the time point in a given row.</li> <li>• Data of type double.</li> </ul> <p>For an example, see Single time/data matrix in the following procedure, step 4. For more information, see “Import Data Arrays” in the Simulink documentation.</p>

Format	Description
Signal-and-time structure	<ul style="list-style-type: none"> <li>• More flexible than the single time/data matrix format.</li> <li>• One variable.</li> <li>• Must contain two top-level fields: <code>time</code> and <code>signals</code>. The <code>time</code> field contains a <i>column</i> vector of the simulation times. The <code>signals</code> field contains an array of substructures, each of which corresponds to an Inport block. The substructure index corresponds to the Inport block number. Each <code>signals</code> substructure must contain a field named <code>values</code>. The <code>values</code> field must contain an array of inputs for the corresponding Inport block, where each input corresponds to a time point specified by the <code>time</code> field.</li> </ul>

Format	Description
	<ul style="list-style-type: none"> <li>• If the <code>time</code> field is set to an empty value, clear the check box for the Inport block <b>Interpolate data</b> parameter.</li> <li>• No data type limitations, but must match Inport block settings.</li> </ul> <p>For an example, see Signal-and-time structure in the following procedure, step 4. For more information on this format, see “Import Data Structures” in the Simulink documentation.</p>

Format	Description
Per-port structure	<ul style="list-style-type: none"> <li>• Most flexible</li> <li>• Multiple variables. Number of variables must equal the number of Inport blocks.</li> <li>• Consists of a separate structure-with-time or structure-without-time for each Inport block. Each Inport block data structure has only one <code>signals</code> field. To use this format, in the <b>Input</b> text field, enter the names of the structures as a comma-separated list, <code>in1, in2, ..., inN</code>, where <code>in1</code> is the data for your model’s first port, <code>in2</code> for the second port, and so on.</li> <li>• Each variable can have a different time vector.</li> <li>• If the <code>time</code> field is set to an empty value, clear the check box for the Inport block <b>Interpolate data</b> parameter.</li> <li>• No data type limitations, but must match Inport block settings.</li> <li>• To save multiple variables to the same data file, you must save them in the order expected by the model, using the <code>-append</code> option.</li> </ul> <p>For an example, see Per-port structure in the following procedure, step 4. For more information, see “Import Data Structures” in the Simulink documentation.</p>

The supported formats and the following procedure are illustrated in `rtwdemo_rsim_i`.

To create a MAT-file for an Inport block:

- 1 Choose one of the preceding data file formats.
- 2 Update Inport block parameter settings and specifications to match specifications of the data to be supplied by the MAT-file.

By default, the Inport block inherits parameter settings from downstream blocks. To import data from an external MAT-file, explicitly set the following parameters to match the source data in the MAT-file.

- **Main > Interpolate data**
- **Signal Attributes > Port dimensions**
- **Signal Attributes > Data type**
- **Signal Attributes > Signal type**

If you choose to use a structure format for workspace variables and the time field is empty, you must clear **Interpolate data** or modify the field so that it is set to a nonempty value. Interpolation requires time data.

For descriptions of the preceding block parameters, see the description of the Inport block in the Simulink documentation.

- 3 Build an RSim executable for the model. The Simulink Coder build process creates and calculates a structural checksum for the model and embeds it in the generated executable. The RSim target uses the checksum to verify that data being passed into the model is consistent with what the model executable expects.
- 4 Create the MAT-file that provides the source data for the rapid simulations. You can create the MAT-file from a workspace variable. Using the specifications in the preceding format comparison table, create the workspace variables for your simulations.

An example of each format follows:

#### Single time/data matrix

```
t=[0:0.1:2*pi]';  
Ina1=[2*sin(t) 2*cos(t)];  
Ina2=sin(2*t);  
Ina3=[0.5*sin(3*t) 0.5*cos(3*t)];
```

```
var_matrix=[t Ina1 Ina2 Ina3];
```

### **Signal-and-time structure**

```
t=[0:0.1:2*pi]';
var_single_struct.time=t;
var_single_struct.signals(1).values(:,1)=2*sin(t);
var_single_struct.signals(1).values(:,2)=2*cos(t);
var_single_struct.signals(2).values=sin(2*t);
var_single_struct.signals(3).values(:,1)=0.5*sin(3*t);
var_single_struct.signals(3).values(:,2)=0.5*cos(3*t);
v=[var_single_struct.signals(1).values...
var_single_struct.signals(2).values...
var_single_struct.signals(3).values];
```

### **Per-port structure**

```
t=[0:0.1:2*pi]';
Inb1.time=t;
Inb1.signals.values(:,1)=2*sin(t);
Inb1.signals.values(:,2)=2*cos(t);
t=[0:0.2:2*pi]';
Inb2.time=t;
Inb2.signals.values(:,1)=sin(2*t);
t=[0:0.1:2*pi]';
Inb3.time=t;
Inb3.signals.values(:,1)=0.5*sin(3*t);
Inb3.signals.values(:,2)=0.5*cos(3*t);
```

- 5** Save the workspace variables to a MAT-file.

### **Single time/data matrix**

The following example saves the workspace variable `var_matrix` to the MAT-file `rsim_i_matrix.mat`.

```
save rsim_i_matrix.mat var_matrix;
```

### **Signal-and-time structure**

The following example saves the workspace structure variable `var_single_struct` to the MAT-file `rsim_i_single_struct.mat`.

```
save rsim_i_single_struct.mat var_single_struct;
```

### Per-port structure

To order data when saving per-port structure variables to a single MAT-file, use the `save` command's `-append` option. Be sure to append the data in the order that the model expects it.

The following example saves the workspace variables `Inb1`, `Inb2`, and `Inb3` to MAT-file `rsim_i_multi_struct.mat`.

```
save rsim_i_multi_struct.mat Inb1;
save rsim_i_multi_struct.mat Inb2 -append;
save rsim_i_multi_struct.mat Inb3 -append;
```

The `save` command does not preserve the order in which you specify your workspace variables in the command line when saving data to a MAT-file. For example, if you specify the variables `v1`, `v2`, and `v3`, in that order, the order of the variables in the MAT-file could be `v2 v1 v3`.

Using a command-line option, you can then specify the MAT-files as input for rapid simulations.

## Scripts for Batch and Monte Carlo Simulations

The RSim target is for batch simulations in which parameters and input signals vary for multiple simulations. New output file names allow you to run new simulations without overwriting prior simulation results. You can set up a series of simulations to run by creating a `.bat` file for use on a Microsoft Windows platform.

Create a file for the Windows platform with any text editor and execute it by typing the file name, for example, `mybatch`, where the name of the text file is `mybatch.bat`.

```
rtwdemo_rsimtf -f rtwdemo_rsimtf.mat=run1.mat -o results1.mat -tf 10.0
rtwdemo_rsimtf -f rtwdemo_rsimtf.mat=run2.mat -o results2.mat -tf 10.0
rtwdemo_rsimtf -f rtwdemo_rsimtf.mat=run3.mat -o results3.mat -tf 10.0
rtwdemo_rsimtf -f rtwdemo_rsimtf.mat=run4.mat -o results4.mat -tf 10.0
```

In this case, batch simulations run using four sets of input data in files `run1.mat`, `run2.mat`, and so on. The RSim executable saves the data to the files specified with the `-o` option.

The variable names containing simulation results in each of the files are identical. Therefore, loading consecutive sets of data without renaming the data once it is in the MATLAB workspace results in overwriting the prior workspace variable with new data. To avoid overwriting, you can copy the result to a new MATLAB variable before loading the next set of data.

You can also write MATLAB scripts to create new signals and new parameter structures, as well as to save data and perform batch runs using the bang command (!).

For details on running simulations and available command-line options, see “Run Rapid Simulations” on page 12-20. For an example of a rapid simulation batch script, see the example `rtwdemo_rsim_batch_script`.

## Run Rapid Simulations

- “” on page 12-20
- “Requirements for Running Rapid Simulations” on page 12-22
- “Set a Clock Time Limit for a Rapid Simulation” on page 12-23
- “Override a Model Simulation Stop Time” on page 12-23
- “Read the Parameter Vector into a Rapid Simulation” on page 12-24
- “Specify New Signal Data File for a From File Block” on page 12-24
- “Specify Signal Data File for an Inport Block” on page 12-27
- “Change Block Parameters for an RSim Simulation” on page 12-30
- “Specify a New Output File Name for a Simulation” on page 12-32
- “Specify New Output File Names for To File Blocks” on page 12-33

Using the RSim target, you can build a model once and run multiple simulations to study effects of varying parameter settings and input signals. You can run a simulation directly from your operating system command line,



redirect the command from the MATLAB command line by using the bang (!) character, or execute commands from a script.

### Operating System Command Line

```
rtwdemo_rsimtf
```

### MATLAB Command Line

```
!rtwdemo_rsimtf
```

The following table lists ways you can use RSim target command-line options to control a simulation.

To...	Use...
Read input data for a From File block from a MAT-file other than the MAT-file used for the previous simulation	<code>model -f oldfilename.mat=newfilename.mat</code>
Print a summary of the options for RSim executable targets	<code>executable filename -h</code>
Read input data for an Inport block from a MAT-file	<code>model -i filename.mat</code>
Time out after $n$ clock time seconds, where $n$ is a positive integer value	<code>model -L n</code>
Write MAT-file logging data to file <code>filename.mat</code>	<code>model -o filename.mat</code>
Read a parameter vector from file <code>filename.mat</code>	<code>model -p filename.mat</code>
Override the default TCP port (17725) for External mode	<code>model -port TCPport</code>
Write MAT-file logging data to a MAT-file other than the MAT-file used for the previous simulation	<code>model -t oldfilename.mat=newfilename.mat</code>
Run the simulation until the time value <code>stoptime</code> is reached	<code>model -tf stoptime</code>

To...	Use...
Run in verbose mode	<code>model -v</code>
Wait for the Simulink engine to start the model in External mode	<code>model -w</code>

The following sections use the `rtwdemo_rsimtf` example model in examples to illustrate some of these command-line options. In each case, the example assumes you have already done the following:

- Created or changed to a working folder.
- Opened the example model.
- Copied the data file `matlabroot/toolbox/rtw/rtwdemos/rsimdemos/rsim_tfdata.mat` to your working folder. You can perform this operation using the command:

```
copyfile(fullfile(matlabroot,'toolbox','rtw','rtwdemos',...
    'rsimdemos','rsim_tfdata.mat'),pwd);
```

## Requirements for Running Rapid Simulations

- You can run the RSim executable on any computer configured to run MATLAB and for which the MATLAB and Simulink installation folder is accessible to the `RSim.exe`. To obtain that access, your `PATH` environment variable must include `/bin` and `/bin/($ARCH)`, where `($ARCH)` represents your operating system architecture. For example, for a personal computer running on a Windows platform, `($ARCH)` is “win32”, whereas for a Linux machine, `($ARCH)` is “glnx86”.
- On GNU Linux platforms, to run an RSim executable, define the `LD_LIBRARY_PATH` environment variable to provide the path to the MATLAB installation folder, as follows:

```
% setenv LD_LIBRARY_PATH /matlab/sys/os/glnx86:$LD_LIBRARY_PATH
```

- On the Apple Macintosh OS X platform, to run RSim target executables, you must define the environment variable `DYLD_LIBRARY_PATH` to include the folders `bin/mac` and `sys/os/mac` under the MATLAB installation

folder. For example, if your MATLAB installation is under /MATLAB, add /MATLAB/bin/mac and /MATLAB/sys/os/mac to the definition for DYLD\_LIBRARY\_PATH.

### Set a Clock Time Limit for a Rapid Simulation

If a model experiences frequent zero crossings and the model's minor step size is small, consider setting a time limit for a rapid simulation. To set a time limit, specify the `-L` option with a positive integer value. The simulation aborts after running for the specified amount of clock time (not simulation time). For example,

```
!rtwdemo_rsintf -L 20
```

Based on your clock, after the executable runs for 20 seconds, the program is terminate. You see one of the following messages:

#### On a Microsoft Windows Platform

```
Exiting program, time limit exceeded  
Logging available data ...
```

#### On The Open Group UNIX Platform

```
** Received SIGALRM (Alarm) signal @ Fri Jul 25 15:43:23 2003  
** Exiting model 'vdp' @ Fri Jul 25 15:43:23 2003
```

You do not need to do anything to your model or to its Simulink Coder configuration to use this option.

### Override a Model Simulation Stop Time

By default, a rapid simulation runs until the simulation time reaches the time specified the Configuration Parameters dialog box, on the **Solver** pane. You can override the model simulation stop time by using the `-tf` option. For example, the following simulation runs until the time reaches 6.0 seconds.

```
!rtwdemo_rsintf -tf 6.0
```

The RSim target stops and logs output data using MAT-file data logging rules.

If the model includes a From File block, the end of the simulation is regulated by the stop time setting specified in the Configuration Parameters dialog box, on the **Solver** pane, or with the RSim target option `-tf`. The values in the block's time vector are ignored. However, if the simulation time exceeds the endpoints of the time and signal matrix (if the final time is greater than the final time value of the data matrix), the signal data is extrapolated to the final time value.

### Read the Parameter Vector into a Rapid Simulation

To read the model parameter vector into a rapid simulation, you must first create a MAT-file that includes the parameter structure as described in “Create a MAT-File That Includes a Model Parameter Structure” on page 12-10. You can then specify the MAT-file in the command line with the `-p` option.

For example:

- 1 Build an RSim executable for the example model `rtwdemo_rsimtf`.
- 2 Modify parameters in your model and save the parameter structure.

```
param_struct = rsimgetrtp('rtwdemo_rsimtf');  
save myrsimdata.mat param_struct
```

- 3 Run the executable with the new parameter set.

```
!rtwdemo_rsimtf -p myrsimdata.mat
```

```
** Starting model 'rtwdemo_rsimtf' @ Tue Dec 27 12:30:16 2005  
** created rtwdemo_rsimtf.mat **
```

- 4 Load workspace variables and plot the simulation results by entering the following commands:

```
load myrsimdata.mat  
plot(rt_yout)
```

### Specify New Signal Data File for a From File Block

If your model's input data source is a From File block, you can feed the block with input data during simulation from a single MAT-file or you can change

the MAT-file from one simulation to the next. Each MAT-file must adhere to the format described in “Create a MAT-File for a From File Block” on page 12-14.

To change the MAT-file after an initial simulation, you specify the executable with the `-f` option and an `oldfile.mat=newfile.mat` parameter, as shown in the following example.

- 1** Set some parameters in the MATLAB workspace. For example:

```
w = 100;  
theta = 0.5;
```

- 2** Build an RSim executable for the example model `rtwdemo_rsimtf`.
- 3** Run the executable.

```
!rtwdemo_rsimtf
```

The RSim executable runs a set of simulations and creates output MAT-files containing the specific simulation result.

- 4** Load the workspace variables and plot the simulation results by entering the following commands:

```
load rtwdemo_rsimtf.mat  
plot(rt_yout)
```

The resulting plot shows simulation results based on default input data.

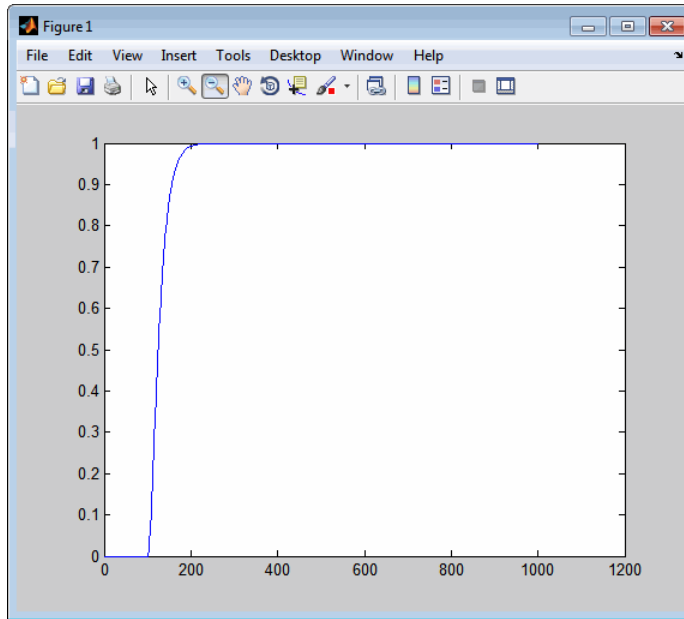

- 5** Create a new data file, `newfrom.mat`, that includes the following data:

```
t=[0:.001:1];  
u=sin(100*t.*t);  
tu=[t;u];  
save newfrom.mat tu;
```

- 6** Run a rapid simulation with the new data by using the `-f` option to replace the original file, `rsim_tfdata.mat`, with `newfrom.mat`.

```
!rtwdemo_rsimtf -f rsim_tfdata.mat=newfrom.mat
```

- 7** Load the data and plot the new results by entering the following commands:

```
load rtwdemo_rsimtf.mat  
plot(rt_yout)
```

The next figure shows the resulting plot.

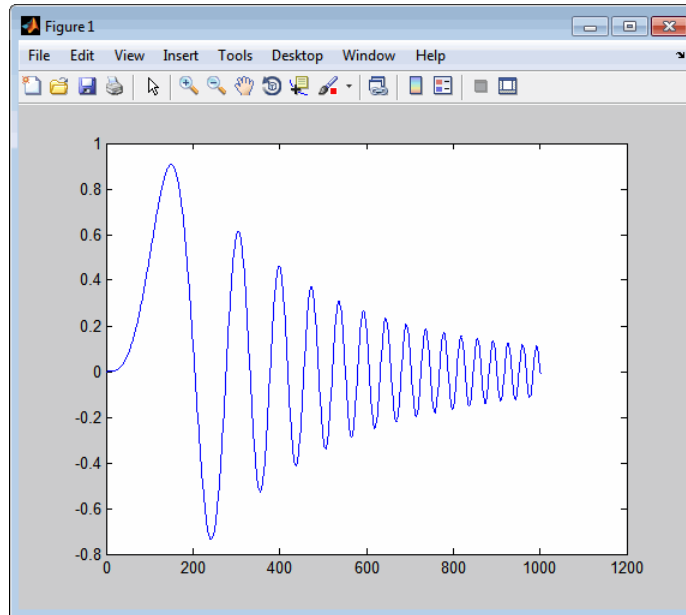

From File blocks require input data of type `double`. If you need to import signal data of a data type other than `double`, use an Inport block (see “Create a MAT-File for an Inport Block” on page 12-15) or a From Workspace block with the data specified as a structure.

Workspace data must be in the format:

```
variable.time
variable.signals.values
```

If you have more than one signal, use the following format:

```
variable.time
variable.signals(1).values
variable.signals(2).values
```

### **Specify Signal Data File for an Inport Block**

If your model’s input data source is an Inport block, you can feed the block with input data during simulation from a single MAT-file or you can change

the MAT-file from one simulation to the next. Each MAT-file must adhere to one of the three formats described in “Create a MAT-File for an Inport Block” on page 12-15.

To specify the MAT-file after a simulation, you specify the executable with the `-i` option and the name of the MAT-file that contains the input data. For example:

- 1** Open the model `rtwdemo_rsim_i`.
- 2** Check the Inport block parameter settings. The following Inport block data parameter settings and specifications that you specify for the workspace variables must match settings in the MAT-file, as indicated in “Configure Inports to Provide Simulation Source Data” on page 12-6:
  - **Main > Interpolate data**
  - **Signal Attributes > Port dimensions**
  - **Signal Attributes > Data type**
  - **Signal Attributes > Signal type**
- 3** Build the model.
- 4** Set up the input signals. For example:

```
t=[0:0.01:2*pi]';  
s1=[2*sin(t) 2*cos(t)];  
s2=sin(2*t);  
s3=[0.5*sin(3*t) 0.5*cos(3*t)];  
plot(t, [s1 s2 s3])
```



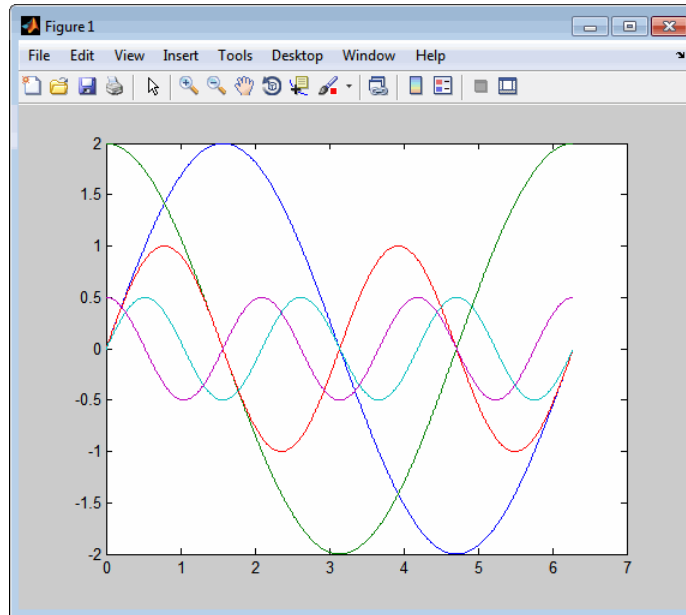

- 5** Prepare the MAT-file by using one of the three available file formats described in “Create a MAT-File for an Inport Block” on page 12-15. The following example defines a signal-and-time structure in the workspace and names it `var_single_struct`.

```
t=[0:0.1:2*pi]';
var_single_struct.time=t;
var_single_struct.signals(1).values(:,1)=2*sin(t);
var_single_struct.signals(1).values(:,2)=2*cos(t);
var_single_struct.signals(2).values=sin(2*t);
var_single_struct.signals(3).values(:,1)=0.5*sin(3*t);
var_single_struct.signals(3).values(:,2)=0.5*cos(3*t);
v=[var_single_struct.signals(1).values...
var_single_struct.signals(2).values...
var_single_struct.signals(3).values];
```

- 6** Save the workspace variable `var_single_struct` to MAT-file `rsm_i_single_struct`.

```
save rsm_i_single_struct.mat var_single_struct;
```

- 7 Run a rapid simulation with the input data by using the `-i` option. Load and plot the results.

```
!rtwdemo_rsim_i -i rsim_i_single_struct.mat

** Starting model 'rtwdemo_rsim_i' @ Tue Dec 27 14:01:20 2005
*** rsim_i_single_struct.mat is loaded! ***
** created rtwdemo_rsim_i.mat **

** Execution time = 0.2683734753333333sload rsim_i_single_struct.mat;
```

- 8 Load and plot the results.

```
load rtwdemo_rsim_i.mat
plot(rt_tout, rt_yout);
```

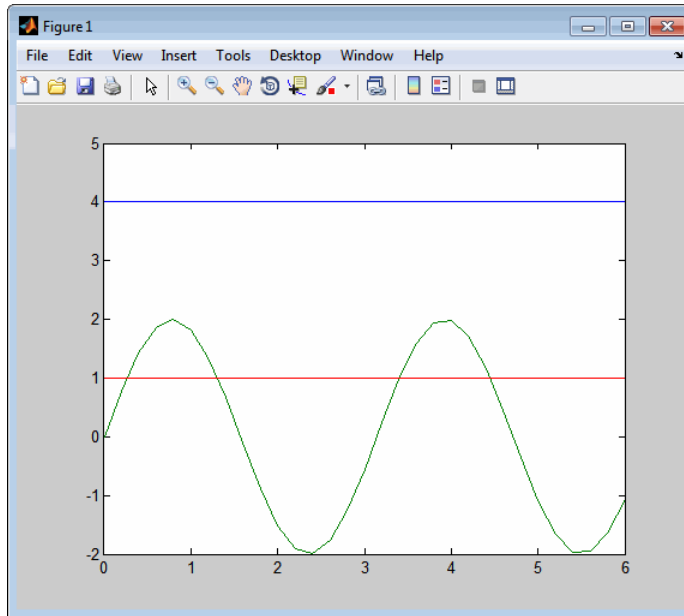

### Change Block Parameters for an RSim Simulation

As described in “Create a MAT-File That Includes a Model Parameter Structure” on page 12-10, after you alter one or more parameters in a

Simulink block diagram, you can extract the parameter vector, *model\_P*, for the entire model. You can then save the parameter vector, along with a model checksum, to a MAT-file. This MAT-file can be read directly by the standalone RSim executable, allowing you to replace the entire parameter vector or individual parameter values, for running studies of variations of parameter values representing coefficients, new data for input signals, and so on.

The RSim target allows you to alter any model parameter, including parameters that include *side-effects* functions. An example of a side-effects function is a simple Gain block that includes the following parameter entry in a dialog box:

```
gain value:  2 * a
```

The Simulink Coder code generator evaluates side-effects functions before generating code. The generated code for this example retains only one memory location entry, and the dependence on parameter *a* is no longer visible in the generated code. The RSim target overcomes the problem of handling side-effects functions by replacing the entire parameter structure, *model\_P*. You must create this new structure by using the `rsimgetrtp` function and then saving it in a MAT-file, as described in “Create a MAT-File That Includes a Model Parameter Structure” on page 12-10.

RSim can read the MAT-file and replace the entire *model\_P* structure whenever you change one or more parameters, without recompiling the entire model.

For example, assume that you changed one or more parameters in your model, generated the new *model\_P* vector, and saved *model\_P* to a new MAT-file called *mylogfile.mat*. To run the same `rtwdemo_rsimtf` model and use these new parameter values, use the `-p` option, as shown in the following example:

```
!rtwdemo_rsimtf -p mylogfile.mat
load rtwdemo_rsimtf
plot(rt_yout)
```

If you have converted the parameter structure to a cell array for running simulations on varying data sets, as described in “Convert the Parameter Structure for Running Simulations on Varying Data Sets” on page 12-12, you must add an `@n` suffix to the MAT-file specification. *n* is the element of the cell array that contains the specific input that you want to use for the simulation.

The following example converts `param_struct` to a cell array, changes parameter values, saves the changes to MAT-file `mymatfile.mat`, and then runs the executable using the parameter values in the second element of the cell array as input.

```
param_struct = rsimgetrtp('rtwdemo_rsimtf');
p = param_struct.parameters;
param_struct.parameters = [];
param_struct.parameters{1} = p;
param_struct.parameters{1}

ans =

    dataTypeName: 'double'
    dataTypeId: 0
    complex: 0
    dtTransIdx: 0
    values: [-140 -4900 0 4900]
param_struct.parameters{2} = param_struct.parameters{1};
param_struct.parameters{2}.values=[-150 -5000 0 4950];
save mymatfile.mat param_struct;
!rtwdemo_rsimtf -p mymatfile.mat@2 -o rsim2.mat
```

### Specify a New Output File Name for a Simulation

If you have specified any of the **Save to Workspace** options — **Time**, **States**, **Outputs**, or **Final States** — in the Configuration Parameters dialog box, on the **Data Import/Export** pane, the default is to save simulation logging results to the file `model.mat`. For example, the example model `rtwdemo_rsimtf` normally saves data to `rtwdemo_rsimtf.mat`, as follows:

```
!rtwdemo_rsimtf
created rtwdemo_rsimtf.mat
```

You can specify a new output file name for data logging by using the `-o` option when you run an executable.

```
!rtwdemo_rsimtf -o rsim1.mat
```

In this case, the set of parameters provided at the time of code generation, including any From File block data, is run.

## Specify New Output File Names for To File Blocks

In much the same way as you can specify a new system output file name, you can also provide new output file names for data saved from one or more To File blocks. To do this, specify the original file name at the time of code generation with a new name, as shown in the following example:

```
!rtwdemo_rsimtf -t rtwdemo_rsimtf_data.mat=mynewrsimdata.mat
```

In this case, assume that the original model wrote data to the output file `rtwdemo_rsimtf_data.mat`. Specifying a new file name forces RSim to write to the file `mynewrsimdata.mat`. With this technique, you can avoid overwriting an existing simulation run.

## Rapid Simulation Target Limitations

The RSim target has the following limitations:

- Does not support algebraic loops.
- Does not support Interpreted MATLAB Function blocks.
- Does not support noninlined MATLAB language or Fortran S-functions.
- If an RSim build includes referenced models (by using Model blocks), set up these models to use fixed-step solvers to generate code for them. The top model, however, can use a variable-step solver as long as all blocks in the referenced models are discrete.
- In certain cases, changing block parameters can result in structural changes to your model that change the model checksum. An example of such a change is changing the number of delays in a DSP simulation. In such cases, you must regenerate the code for the model.
- Variable-step solver support for RSim is not available on Microsoft Windows platforms when you use the Watcom C/C++ compiler.

## Generated S-Function Block

S-functions are an important class of target for which the Simulink Coder product can generate code. The ability to encapsulate a subsystem into an S-function allows you to increase its execution efficiency and facilitate code reuse.

The following sections describe the properties of S-function targets and illustrate how to generate them. For more details on the structure of S-functions, see “Host-Specific Code”.

### In this section...

- “About Object Libraries” on page 12-34
- “Create S-Function Blocks from a Subsystem” on page 12-37
- “Tunable Parameters in Generated S-Functions” on page 12-42
- “System Target File and Template Makefiles” on page 12-44
- “Checksums and the S-Function Target” on page 12-45
- “S-Function Target Limitations” on page 12-45

## About Object Libraries

- “About the S-Function Target” on page 12-34
- “Required Files for S-Function Deployment” on page 12-36
- “Sample Time Propagation in Generated S-Functions” on page 12-37
- “Choose a Solver Type” on page 12-37

## About the S-Function Target

Using the S-function target, you can build an S-function component and use it as an S-Function block in another model. The S-function code format used by the S-function target generates code that conforms to the Simulink C MEX S-function application programming interface (API). Applications of this format include

- Conversion of a model to a component. You can generate an S-Function block for a model, m1. Then, you can place the generated S-Function block in another model, m2. Regenerating code for m2 does not require regenerating code for m1.
- Conversion of a subsystem to a component. By extracting a subsystem to a separate model and generating an S-Function block from that model, you can create a reusable component from the subsystem. See “Create S-Function Blocks from a Subsystem” on page 12-37 for an example of this procedure.
- Speeding up simulation. In many cases, an S-function generated from a model performs more efficiently than the original model.
- Code reuse. You can incorporate multiple instances of one model inside another without replicating the code for each instance. Each instance will continue to maintain its own unique data.

The S-function target generates noninlined S-functions. Within the same release, you can generate an executable from a model that contains generated S-functions by using the generic real-time or real-time malloc targets. This is not supported when incorporating a generated S-function from one release into a model that you build with a different release.

You can place a generated S-Function block into another model from which you can generate another S-function. This allows any level of nested S-functions. For limitations related to nesting, see “Limitations on Nesting S-Functions” on page 12-50.

---

**Note** While the S-function target provides a means to deploy an application component for reuse while shielding its internal logic from inspection and modification, the preferred solutions for protecting intellectual property in distributed components are:

- The protected model, a referenced model from which all block and line information has been eliminated using the Model Protection facility. For more information, see “Protected Model” in the Simulink documentation.
  - The Embedded Coder shared library system target file, used to generate a shared library for a model or subsystem for use in a system simulation external to Simulink. For more information see “Shared Object Libraries” in the Embedded Coder documentation.
- 

### Required Files for S-Function Deployment

To deploy your generated S-Function block for inclusion in other models for simulation, you need only provide the binary MEX-file object that was generated in the current working folder when the S-Function block was created:

*subsys\_sf.mexext*

where *subsys* is the subsystem name and *mexext* is a platform-dependent MEX-file extension (see *mexext*). For example, `SourceSubsys_sf.mexw32`.

To deploy your generated S-Function block for inclusion in other models for code generation, you must provide all of the files that were generated in the current working folder when the S-Function block was created:

- *subsys\_sf.c* or *.cpp*, where *subsys* is the subsystem name (for example, `SourceSubsys_sf.c`)
- *subsys\_sf.h*
- *subsys\_sf.mexext*, where *mexext* is a platform-dependent MEX-file extension (see *mexext*)
- Subfolder *subsys\_sfcn\_rtw* and its contents



## Sample Time Propagation in Generated S-Functions

A generated S-Function block can inherit its sample time from the model in which it is placed if certain criteria are met. Conditions that govern sample time propagation for both Model blocks and generated S-Function blocks are described in “Inherit Sample Times” in the Simulink documentation and “Inherited Sample Time for Referenced Models” on page 3-29 in the Simulink Coder documentation.

To generate an S-Function block that meets the criteria for inheriting sample time, you must constrain the solver for the model from which the S-Function block is generated. On the **Solver** configuration parameters dialog pane, set **Type** to **Fixed-step** and **Periodic sample time constraint** to **Ensure sample time independent**. If the model is unable to inherit sample times, this setting causes the Simulink software to display an error message when building the model. See “Periodic sample time constraint” in the Simulink documentation for more information about this option.

## Choose a Solver Type

If the model containing the subsystem from which you generate an S-function uses a variable-step solver, the generated S-function contains zero-crossing functions and will work properly only in models that use variable-step solvers.

If the model containing the subsystem from which you generate an S-function uses a fixed-step solver, the generated S-function contains no zero-crossing functions and the generated S-function will work properly in models that use variable-step or fixed-step solvers.

## Create S-Function Blocks from a Subsystem

This section illustrates how to extract a subsystem from a model and generate a reusable S-function component from it.

The next figure shows `SourceModel`, a simple model that inputs signals to a subsystem. The subsequent figure shows the subsystem, `SourceSubsys`. The signals, which have different widths and sample times, are

- A Step block with sample time 1
- A Sine Wave block with sample time 0.5

- A Constant block whose value is the vector [-2 3]

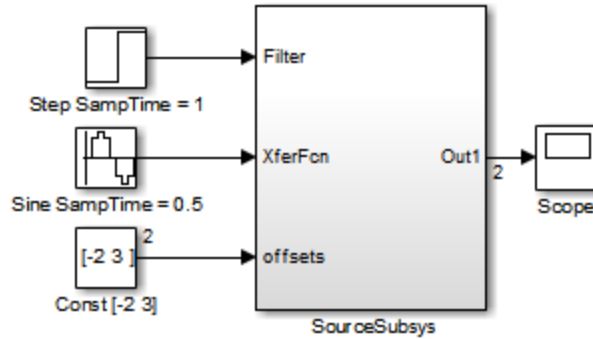

**SourceModel**

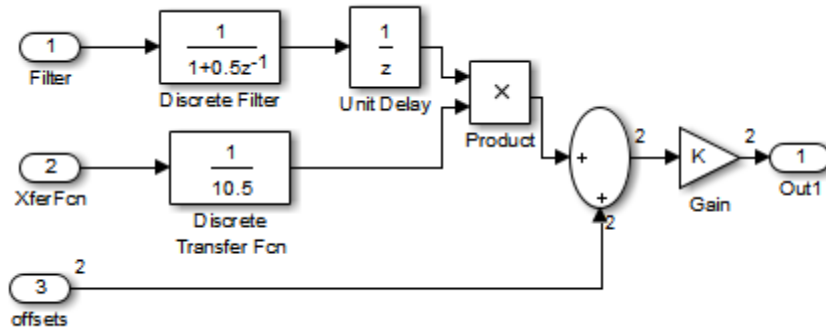

**SourceSubsys**

The objective is to extract SourceSubsys from the model and build an S-Function block from it, using the S-function target. The S-Function block must perform identically to the subsystem from which it was generated.

In this model, SourceSubsys inherits sample times and signal widths from its input signals. However, S-Function blocks created from a model using the S-function target will have all signal attributes (such as signal widths or sample times) hard-wired. (The sole exception to this rule concerns sample times, as described in “Sample Time Propagation in Generated S-Functions” on page 12-37.)

In this example, you want the S-Function block to retain the properties of `SourceSubsys` as it exists in `SourceModel1`. Therefore, before you build the subsystem as a separate S-function component, you must set the inport sample times and widths explicitly. In addition, the solver parameters of the S-function component must be the same as those of the original model. The generated S-function component will operate identically to the original subsystem (see “Choose a Solver Type” on page 12-37 for an exception to this rule).

To build `SourceSubsys` as an S-function component,

- 1** Create a new model and copy/paste the `SourceSubsys` block into the empty window.
- 2** Set the signal widths and sample times of inports inside `SourceSubsys` such that they match those of the signals in the original model. Inport 1, `Filter`, has a width of 1 and a sample time of 1. Inport 2, `XferFcn`, has a width of 1 and a sample time of 0.5. Inport 3, `offsets`, has a width of 2 and a sample time of 0.5.
- 3** The generated S-Function block should have three inports and one output. Connect inports and an output to `SourceSubsys`, as shown in the next figure.

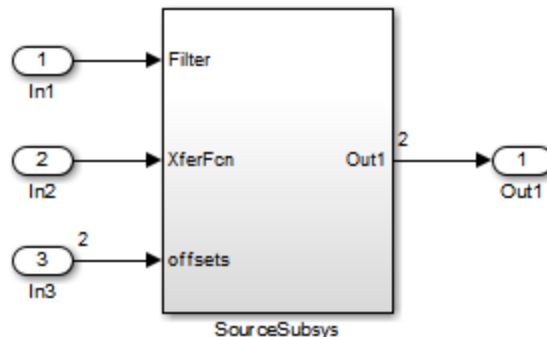

The signal widths and sample times are propagated to these ports.

- 4 Set the solver type, mode, and other solver parameters such that they are identical to those of the source model. This is easiest to do if you use Model Explorer.
- 5 In the Configuration Parameters dialog box, go to the **Code Generation** pane.
- 6 Click **Browse** to open the System Target File Browser.
- 7 In the System Target File Browser, select the S-function target, `rtwsfcn.tlc`, and click **OK**. The **Code Generation** pane appears as follows.

The screenshot shows the 'Code Generation' pane of the Configuration Parameters dialog box. It is divided into three main sections:

- Target selection:** The 'System target file' is set to `rtwsfcn.tlc`. The 'Language' is set to 'C'. The 'Description' is 'S-function Target'. A 'Browse...' button is visible to the right of the system target file field.
- Build process:** The 'Compiler optimization level' is set to 'Optimizations off (faster builds)'. The 'TLC options' field is empty. Under 'Makefile configuration', the 'Generate makefile' checkbox is checked. The 'Make command' is `make_rtw` and the 'Template makefile' is `rtwsfcn_default_tmf`.
- Code Generation Advisor:** The 'Select objective' is set to 'Unspecified'. The 'Check model before generating code' is set to 'Off'. A 'Check model ...' button is to the right. At the bottom, there is a 'Generate code only' checkbox (unchecked) and a 'Build' button.

- 8 Select the **S-Function Target** pane. Make sure that **Create new model** is selected, as shown in the next figure:

The screenshot shows the 'S-Function Target' pane of the Configuration Parameters dialog box. It contains three checkboxes:

- Create new model
- Use value for tunable parameters
- Include custom source code

When this option is selected, the build process creates a new model after it builds the S-function component. The new model contains an S-Function block, linked to the S-function component.

Click **Apply**.

- 9 Save the new model containing your subsystem, for example as SourceSubsys.
- 10 Build the model.
- 11 The Simulink Coder build process builds the S-function component in the working folder. After the build, a new model window is displayed.

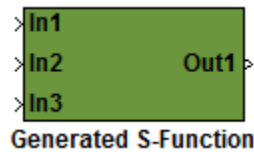

Optionally you can save the generated model, for example as SourceSubsys\_Sfunction.

- 12 You can now copy the Simulink Coder S-Function block from the new model and use it in other models or in a library.

---

**Note** For a list of files required to deploy your S-Function block for simulation or code generation, see “Required Files for S-Function Deployment” on page 12-36.

---

The next figure shows the S-Function block plugged into the original model. Given identical input signals, the S-Function block will perform identically to the original subsystem.

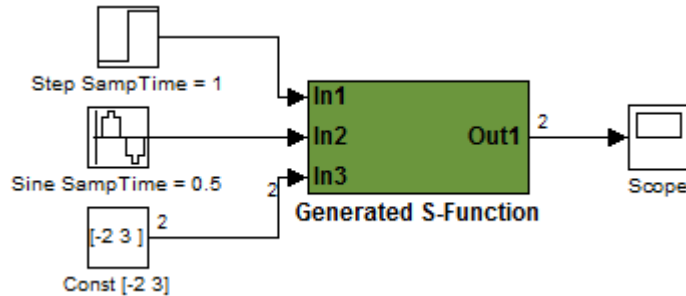

### Generated S-Function Configured Like SourceModel

The speed at which the S-Function block executes is typically faster than the original model. This difference in speed is more pronounced for larger and more complicated models. By using generated S-functions, you can increase the efficiency of your modeling process.

## Tunable Parameters in Generated S-Functions

You can use tunable parameters in generated S-functions in two ways:

- Use the **Generate S-function** feature (see “Automate S-Function Generation” on page 14-23).
- or
- Use the Model Parameter Configuration dialog box (see “Parameters” on page 7-10) to declare desired block parameters tunable.

Block parameters that are declared tunable with the `auto` storage class in the source model become tunable parameters of the generated S-function. These parameters do not become part of a generated `model_P` (formerly `rtP`) parameter data structure, as they would in code generated from other targets. Instead, the generated code accesses these parameters by using MEX API calls such as `mxGetPr` or `mxGetData`. Your code should access these parameters in the same way.

For more information on MEX API calls, see “About Writing C S-Functions” and “Application Programming Interfaces to MATLAB”.

S-Function blocks created by using the S-function target are automatically masked. The mask displays each tunable parameter in an edit field. By default, the edit field displays the parameter by variable name, as in the following example.

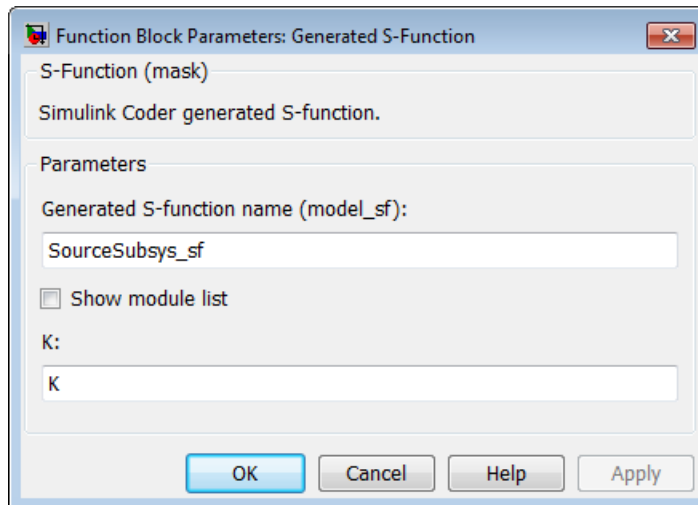

You can choose to display the value of the parameter rather than its variable name by selecting **Use value for tunable parameters** on the **Code Generation > S-Function Target** pane of the Configuration Parameters dialog box.

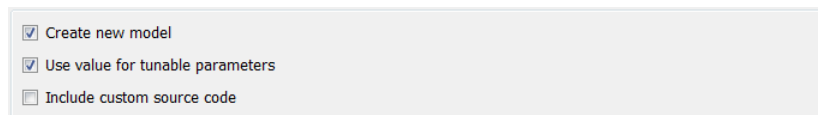

When this option is chosen, the value of the variable (at code generation time) is displayed in the edit field, as in the following example.

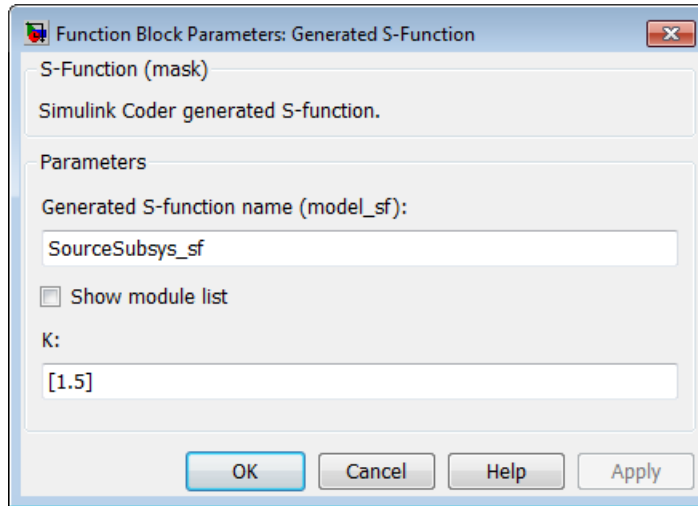

## System Target File and Template Makefiles

- “About System Target File and Template Makefiles” on page 12-44
- “System Target File” on page 12-44
- “Template Makefiles” on page 12-44

### About System Target File and Template Makefiles

This section lists the target file and template makefiles that are provided for use with the S-function target.

#### System Target File

- `rtwsfcn.tlc`

#### Template Makefiles

- `rtwsfcn_lcc.tmf` — Lcc compiler
- `rtwsfcn_unix.tmf` — The Open Group UNIX host



- `rtwsfcn_vc.tmf` — Microsoft Visual C++ compiler
- `rtwsfcn_watc.tmf` — Watcom C compiler

## Checksums and the S-Function Target

The Simulink Coder software creates a checksum for a Simulink model and uses the checksum during the build process for code reuse, model reference, and External mode features.

The Simulink Coder software calculates a model's checksum by

- 1 Calculating a checksum for each subsystem in the model. A subsystem's checksum is the combination of properties (data type, complexity, sample time, port dimensions, and so forth) of the subsystem's blocks.
- 2 Combining the subsystem checksums and other model-level information.

An S-function can add additional information, not captured during the block property analysis, to a checksum by calling the function `ssSetChecksumVal`. For the S-Function target, the value that gets added to the checksum is the checksum of the model or subsystem from which the S-function is generated.

The Simulink Coder software applies the subsystem and model checksums as follows:

- Code reuse — If two subsystems in a model have the same checksum, the Simulink Coder build process generates code for one function only.
- Model reference — If the current model checksum matches the checksum when the model was built, the Simulink Coder build process does not rebuild submodels.
- External mode — If the current model checksum does not match the checksum of the code that is running on the target, the Simulink Coder build process generates an error.

## S-Function Target Limitations

- “Limitations on Using Tunable Variables in Expressions” on page 12-46

- “Run-Time Parameters and S-Function Compatibility Diagnostics” on page 12-46
- “Limitations on Using Goto and From Block” on page 12-47
- “Limitations on Building and Updating S-Functions” on page 12-48
- “Unsupported Blocks” on page 12-49
- “SimState Not Supported for Code Generation” on page 12-49
- “Profiling Code Performance Not Supported” on page 12-50
- “Limitations on Nesting S-Functions” on page 12-50
- “Limitations on User-Defined Data Types” on page 12-50
- “Limitation on Right-Click Generation of an S-Function Target” on page 12-50
- “Limitation on S-Functions with Bus I/O Signals” on page 12-51
- “Limitation on Subsystems with Function-Call I/O Signals” on page 12-51

### **Limitations on Using Tunable Variables in Expressions**

Certain limitations apply to the use of tunable variables in expressions. When Simulink Coder software encounters an unsupported expression during code generation, a warning appears and the equivalent numeric value is generated in the code. For a list of the limitations, see “Tunable Expression Limitations” on page 15-131.

### **Run-Time Parameters and S-Function Compatibility Diagnostics**

If you set the **S-function upgrades needed** option on the **Diagnostics > Compatibility** pane of the Configuration Parameters dialog box to warning or error, the Simulink Coder software instructs you to upgrade S-functions that you create with the **Generate S-function** feature. This is because the S-function target does not register run-time parameters. Run-time parameters are only supported for inlined S-Functions and the generated S-Function supports features that prevent it from being inlined (for example, it can call or contain other noninlined S-functions).

You can work around this limitation by setting the **S-function upgrades needed** option to none. Alternatively, if you have an Embedded Coder

license, select the **Create Embedded Coder SIL block** check box on the **Generate S-function for Subsystem** dialog box and create a SIL block (containing the ERT S-function). In this case, you do not receive the upgrade messages. However, you cannot include SIL blocks inside other generated S-functions recursively.

### Limitations on Using Goto and From Block

When using the S-function target, the Simulink Coder code generator restricts I/O to correspond to the root model's Inport and Outport blocks (or the Inport and Outport blocks of the Subsystem block from which the S-function target was generated). No code is generated for Goto or From blocks.

To work around this restriction, create your model and subsystem with the required Inport and Outport blocks, instead of using Goto and From blocks to pass data between the root model and subsystem. In the model that incorporates the generated S-function, you would then add Goto and From blocks.

### Example Before Work Around

- Root model with a From block and subsystem, Subsystem1

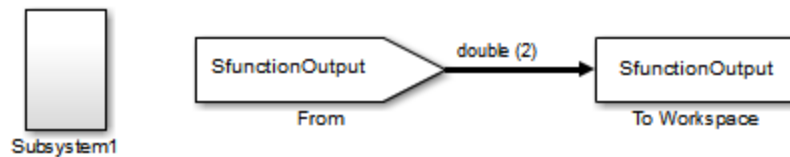

- Subsystem1 with a Goto block, which has global visibility and passes its input to the From block in the root model

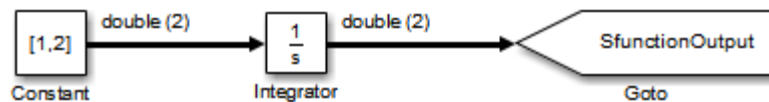

- Subsystem1 replaced with an S-function generated with the S-Function target — a warning results when you run the model because the generated S-function does not implement the Goto block

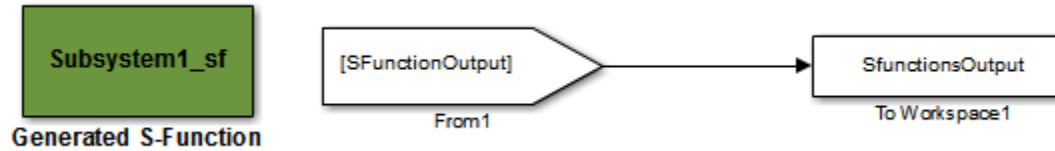

### Example After Work Around

An Outport block replaces the GoTo block in Subsystem1. When you plug the generated S-function into the root model, its output connects directly to the To Workspace block.

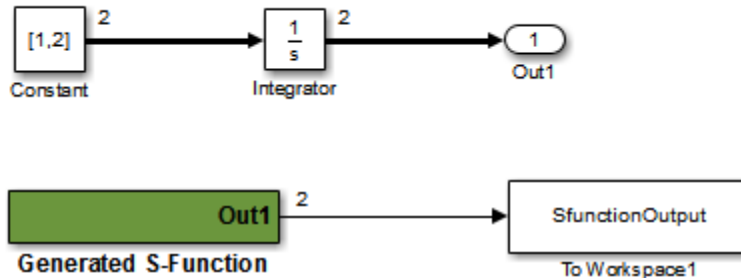

### Limitations on Building and Updating S-Functions

The following limitations apply to building and updating S-functions using the Simulink Coder S-function target:

- You cannot build models that contain Model blocks using the Simulink Coder S-function target. This also means that you cannot build a subsystem module by right-clicking (or by using **Code > C/C++ Code > Build Selected Subsystem**) if the subsystem contains Model blocks. This restriction applies only to S-functions generated using the S-function target, not to ERT S-functions.

- If you modify the model that generated an S-Function block, the Simulink Coder build process does not automatically rebuild models containing the generated S-Function block. This is in contrast to the practice of automatically rebuilding models referenced by Model blocks when they are modified (depending on the Model Reference **Rebuild** configuration setting).
- Handwritten S-functions without corresponding TLC files must contain exception-free code. For more information on exception-free code, see “Exception Free Code” in the Simulink documentation.

### Unsupported Blocks

The S-function format does not support the following built-in blocks:

- Interpreted MATLAB Function block
- S-Function blocks containing any of the following:
  - MATLAB language S-functions (unless you supply a TLC file for C code generation)
  - Fortran S-functions (unless you supply a TLC file for C code generation)
  - C/C++ MEX S-functions that call into the MATLAB environment
- Scope block
- To Workspace block

The S-function format does not support blocks from the `embeddedsimlib` block library in the Embedded Coder product.

### SimState Not Supported for Code Generation

You can use `SimState` within C-MEX and Level-2 MATLAB language S-functions to save and restore the simulation state (see “S-Function Compliance with the `SimState`” in the Simulink documentation). However, `SimState` is not supported for code generation, including with the Simulink Coder S-function target.

## Profiling Code Performance Not Supported

Profiling the performance of generated code using the Target Language Compiler (TLC) hook function interface described by the example model `rtwdemo_profile` is not supported for the S-function target.

## Limitations on Nesting S-Functions

The following limitations apply to nesting a generated S-Function block in a model or subsystem from which you generate another S-function:

- The software does not support nonvirtual bus input and output signals for a nested S-function.
- You should avoid nesting an S-function in a model or subsystem having the same name as the S-function (possibly several levels apart). In such situations, the S-function can be called recursively. The software currently does not detect such loops in S-function dependency, which can result in aborting or hanging your MATLAB session. To prevent this from happening, be sure to name the subsystem or model to be generated as an S-function target uniquely, to avoid duplicating any existing MEX filenames on the MATLAB path.

## Limitations on User-Defined Data Types

The Simulink Coder S-function target does not support the `HeaderFile` property that can be specified on user-defined data types, including those based on `Simulink.AliasType`, `Simulink.Bus`, and `Simulink.NumericType` objects. If a user-defined data type in your model uses the `HeaderFile` property to specify an associated header file, Simulink Coder S-function target code generation disregards the value and does not generate a corresponding include statement.

## Limitation on Right-Click Generation of an S-Function Target

If you generate an S-function target by right-clicking a Function-Call Subsystem block, the original subsystem and the generated S-function might not be consistent. An inconsistency occurs when the **States when enabling** parameter of the Trigger Port block inside the Function-Call Subsystem block is set to **inherit**. You must set the **States when enabling** parameter to **reset** or **held**, otherwise Simulink reports an error.

### **Limitation on S-Functions with Bus I/O Signals**

If an S-function generated using the S-function target has bus input or output signals, the generated bus data structures might include padding to align fields of the bus elements with the Simulink representation used during simulation. However, if you insert the S-function in a model and generate code using a model target such as `grt.tlc`, the bus structure alignment generated for the model build might be incompatible with the padding generated for the S-function and might affect the numerical results of code execution. To make the structure alignment consistent between model simulation and execution of the model code, for each `Simulink.Bus` object, you can modify the `HeaderFile` property to remove the unpadding bus structure header file. This will cause the bus typedefs generated for the S-function to be reused in the model code.

### **Limitation on Subsystems with Function-Call I/O Signals**

The S-function target does not support creating an S-Function block from a subsystem that has a function-call trigger input or a function-call output.





# Real-Time Systems

---

- “Real-Time System Rapid Prototyping” on page 13-2
- “Hardware-In-the-Loop (HIL) Simulation” on page 13-5

## Real-Time System Rapid Prototyping

### In this section...

“About Real-Time Rapid Prototyping” on page 13-2

“Goals of Real-Time Rapid Prototyping” on page 13-3

“Refine Code With Real-Time Rapid Prototyping” on page 13-3

### About Real-Time Rapid Prototyping

Real-time rapid prototyping requires the use of a real-time simulator, potentially connected to system hardware (for example, physical plant or vehicle) being controlled. You generate, deploy, and tune code as it runs on the real-time simulator or embedded microprocessor. This design step is crucial for verifying whether a component can adequately control the system, and allows you to assess, interact with, and optimize code.

The following figure shows a typical approach for real-time rapid prototyping.

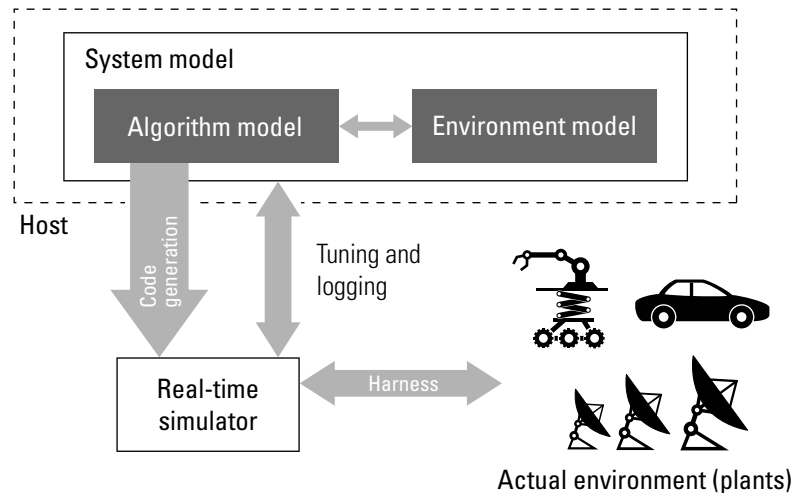

## Goals of Real-Time Rapid Prototyping

Assuming that you have documented functional requirements, refined concept models, system hardware for the physical plant or vehicle being controlled, and access to target products you intend to use (for example, for example, the xPC Target or Real-Time Windows Target product), you can use real-time prototyping to:

- Refine component and environment model designs by rapidly iterating between algorithm design and prototyping
- Validate whether a component can adequately control the physical system in real time
- Evaluate system performance before laying out hardware, coding production software, or committing to a fixed design
- Test hardware

## Refine Code With Real-Time Rapid Prototyping

To perform real-time rapid prototyping:

- 1** Create or acquire a real-time system that runs in real time on rapid prototyping hardware. The xPC Target product facilitates real-time rapid prototyping. This product provides a real-time operating system that makes PCs run in real time. It also provides device driver blocks for numerous hardware I/O cards. You can then create a rapid prototyping system using inexpensive commercial-off-the-shelf (COTS) hardware. In addition, third-party vendors offer products based on the xPC Target product or other code generation technology that you can integrate into a development environment.
- 2** Use Simulink Coder system target files to generate code that you can deploy onto a real-time simulator. See the following information.

<b>Engineering Tasks</b>	<b>Related Product Information</b>	<b>Examples</b>
Generate code for real-time rapid prototyping	<p>“Targets and Code Formats” on page 9-29 in the Simulink Coder documentation</p> <p>Embedded Coder</p> <p>“What Are the Standards and Guidelines?” in the Embedded Coder documentation</p>	<p>rtwdemo_counter</p> <p>rtwdemo_async</p>
Generate code for rapid prototyping in hard real time, using PCs	<p>xPC Target</p> <p>“Setting Configuration Parameters” in the xPC Target documentation</p>	<p>help xpcdemos</p>
Generate code for rapid prototyping in soft real time, using PCs	<p>Real-Time Windows Target</p> <p>“Code Generation Pane: Real-Time Windows Target” in the Real-Time Windows Target documentation</p>	<p>rtvdp (and others)</p>

**3** Monitor signals, tune parameters, and log data.

## Hardware-In-the-Loop (HIL) Simulation

In this section...
“About Hardware-In-the-Loop Simulation” on page 13-5
“Set Up and Run HIL Simulations” on page 13-6

### About Hardware-In-the-Loop Simulation

Hardware-in-the-loop (HIL) simulation tests and verifies an embedded system or control unit in the context of a software test platform. Examples of test platforms include real-time target systems and instruction set simulators (ISSs). You use Simulink software to develop and verify a model that represents the test environment. Using the Simulink Coder product, you then generate, build, and download an executable for the model to the HIL simulation platform. After you set up the environment, you can run the executable to validate the embedded system or control unit in real time.

During HIL simulation, you gradually replace parts of a system environment with hardware components as you refine and fabricate the components. HIL simulation offers an efficient design process that eliminates costly iterations of part fabrication.

The code that you build for the system simulator provides real-time system capabilities. For example, the code can include VxWorks from Wind River or another real-time operating system (RTOS).

The following figure shows a typical HIL setup.

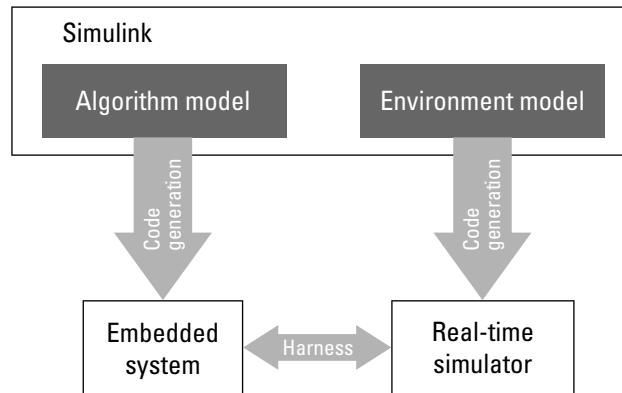

The HIL platform available from MathWorks is the xPC Target product. Several third-party products are also available for use as HIL platforms. The xPC Target product offers hard real-time performance for any PC with Intel® or AMD® 32-bit processors functioning as your real-time target. The xPC Target product enables you to add I/O interface blocks to your models and automatically generate code with code generation technology. The xPC Target product can download the code to a second PC running the xPC Target real-time kernel. System integrator solutions that are based on xPC Target are also available.

## Set Up and Run HIL Simulations

To set up and run HIL simulations iterate through the following steps:

- 1 Develop a model that represents the environment or system under development. For more information, see:
  - “Targets and Code Formats” on page 9-29
- 2 Generate an executable for the environment model.
- 3 Download the executable for the environment model to the HIL simulation platform.
- 4 Replace software representing a system component with corresponding hardware.
- 5 Test the hardware in the context of the HIL system.

- 6 Repeat steps 4 and 5 until you can simulate the system after including all components that require testing.





# External Code Integration

---

- “Integration Options” on page 14-2
- “Reuse Algorithmic Components in Generated Code” on page 14-5
- “Deploy Algorithm Code Within a Target Environment” on page 14-14
- “Export Generated Algorithm Code for Embedded Applications” on page 14-18
- “Export Algorithm Executables for System Simulation” on page 14-21
- “Modify External Code for Language Compatibility” on page 14-22
- “Automate S-Function Generation” on page 14-23
- “Integrate External Code Using Legacy Code Tool” on page 14-28
- “Configure Model for External Code Integration” on page 14-33
- “Insert Custom Code Blocks” on page 14-36
- “Insert S-Function Code” on page 14-46

## Integration Options

In this section...
“About Integration Options” on page 14-2
“Types of External Code Integration” on page 14-2

### About Integration Options

The Simulink Coder product includes a variety of approaches for integrating legacy or custom code with generated code. *Legacy code* is existing handwritten code or code for environments that must be integrated with code generated by the Simulink Coder software. *Custom code* is legacy code or any other user-specified lines of code that must be included in the Simulink Coder build process. Collectively, legacy and custom code are called *external code*.

There are two ways that you can achieve external code integration. You can import existing external code into code generated by code generation technology or you can export generated code into an existing external code base. For example, you might want to use generated code as a plug-in function.

### Types of External Code Integration

Based on application goals, external code integration can be characterized as follows:

- Import external code into generated code
  - Reuse of an algorithmic component in generated code
  - Deploy an application with algorithm code within the target environment
  - Generate target optimizations within algorithm code
- Export generated code into external code
  - Export generated algorithm code for an embedded application
  - Export an algorithm executable for system simulation

Use the following flow diagram to prepare for integration and choose integration paths that best map to your application components. As the

diagram shows, before you make integration decisions, assess your application architecture and partition it as much as possible. Working with smaller units makes it easier to map algorithms to modeling components and decide how to integrate the components. For each component, use the highlighted area of the flow diagram to identify the most applicable type of integration. Then, see the information provided for the corresponding type.

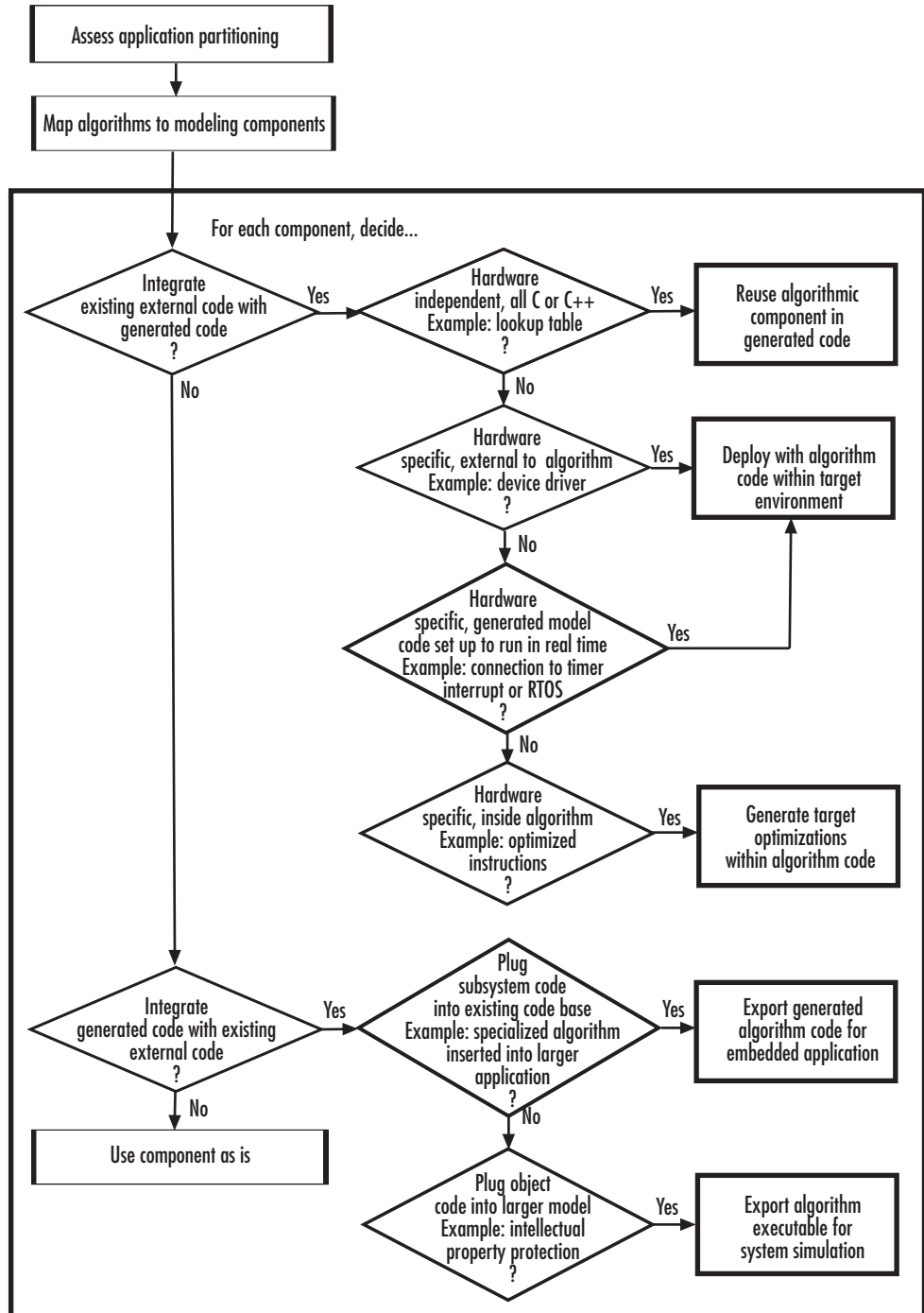

## Reuse Algorithmic Components in Generated Code

### In this section...

“Reusable Algorithmic Components” on page 14-5

“Integrate External MATLAB Code” on page 14-5

“Integrate External C or C++ Code” on page 14-8

“Integrate Fortran Code” on page 14-11

“Integration Considerations for Reusable Algorithmic Components” on page 14-11

### Reusable Algorithmic Components

You have several options for integrating reusable algorithmic components with the generated code. Such components are hardware-independent and can be verified with Simulink simulation. Examples of such components include:

- Lookup tables
- Math utilities
- Digital filters
- Special integrators
- Proportional–integral–derivative (PID) control modules

Some integration options allow you to integrate external code for a reusable component directly, while other options convert external code to modeling elements. To take full advantage of Model-Based Design, convert code to modeling elements which you can then use in the Simulink or Stateflow simulation environment. Doing so enables you to simulate and generate code for an integrated component and, for example, use software-in-the-loop (SIL) or processor-in-the-loop (PIL) testing to verify whether algorithm behavior is the same in both environments.

### Integrate External MATLAB Code

The following diagram identifies common characteristics or requirements for reusable algorithmic components written in MATLAB code and recommends

solutions in each case. The table that follows the diagram provides more detail. Collectively, the diagram and table help you choose the best solution for your application and find more related information.

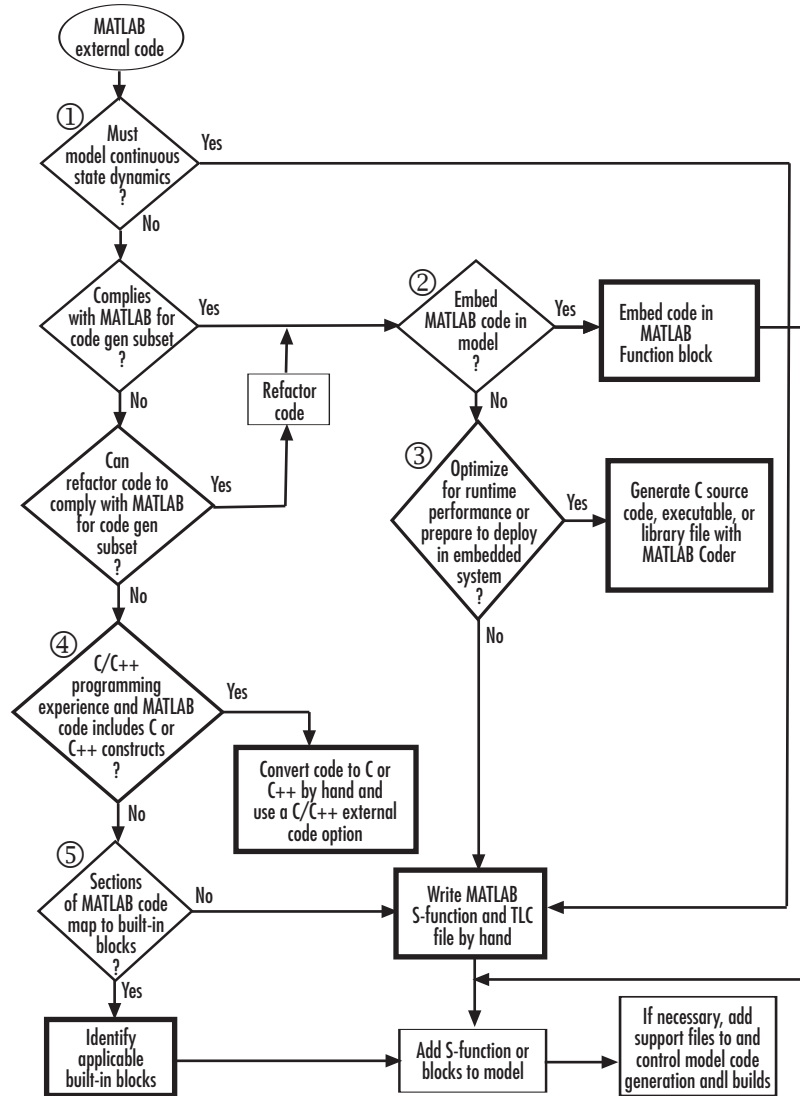

	<b>If...</b>	<b>Then...</b>	<b>For More Information, See...</b>
1	The algorithm must model continuous state dynamics	Write a MATLAB S-function and, for generating code, a corresponding TLC file for the algorithm and add the S-function to your model	<ul style="list-style-type: none"> <li>• “MATLAB S-Functions”</li> <li>• “Inline MATLAB File S-Functions”</li> </ul>
2	You want to embed MATLAB code directly in the model	Add a MATLAB Function block to the model and embed the MATLAB code in that block	MATLAB Function
3	You need to optimize runtime performance or prepare to deploy the code in an embedded system	Use MATLAB Coder software to generate a C source code, executable, or library file	“Getting Started with MATLAB Coder”
4	You have C or C++ programming experience and the external MATLAB code is compact and primarily uses C or C++ constructs	Convert the MATLAB code to C or C++ code manually and choose an option for integrating the C or C++ code	“Integrate External C or C++ Code” on page 14-8
5	Sections of the external MATLAB code map to built-in blocks	Develop the algorithm in the context of a model, using the applicable built in blocks	<ul style="list-style-type: none"> <li>• “Modeling Basics” and “Component-Based Modeling”</li> <li>• “Supported Products and Block Usage” on page 1-92</li> </ul>

To embed external MATLAB code in a MATLAB Function block or generate C or C++ code from MATLAB code with the MATLAB Coder software, the MATLAB code must use functions suitable for code generation.

## Integrate External C or C++ Code

The following diagram identifies common characteristics or requirements for reusable algorithmic components written in C or C++ code and recommends solutions in each case. The table that follows the diagram provides more detail. Collectively, the diagram and table will help you choose the best solution for your application and find more related information.

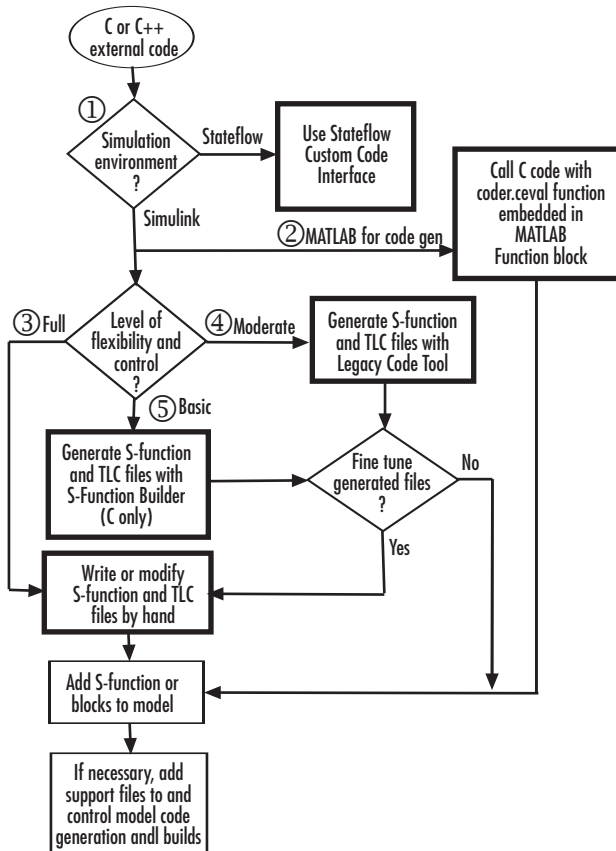



	<b>If...</b>	<b>Then...</b>	<b>For More Information, See...</b>
1	The external code will simulate in a Stateflow environment	Use the Stateflow custom code interface	<ul style="list-style-type: none"> <li>• <code>sf_custom</code></li> <li>• “Calling Custom C Code Functions” in the Stateflow documentation</li> </ul>
2	Performance is not an issue and you want to quickly embed a call to external C or C++ code in a model	Call the C or C++ code with the <code>coder.ceval</code> function from a MATLAB Function block	<ul style="list-style-type: none"> <li>• <code>coder.ceval</code> function description</li> <li>• MATLAB Function block</li> </ul>
3	You want maximum flexibility and the ability to control what code is generated; the application requires function overloading or you need to format data definitions such that they are compatible with a function	Write an S-function and TLC file manually	<ul style="list-style-type: none"> <li>• “C S-Function Examples” and “C++ S-Function Examples”</li> <li>• “S-Function Basics”</li> <li>• “Insert S-Function Code” on page 14-46</li> </ul>
4	You want ease of use with moderate flexibility to control what code gets generated, typically for discrete applications; you have C or C++ programming experience, but prefer to generate the files that add the code to a model; optimizing generated code is essential	Use the Legacy Code Tool to generate the S-function and TLC files; optionally, you can fine-tune the generated files manually to better meet application needs	<ul style="list-style-type: none"> <li>• <code>rtwdemo_lct_lut_script</code></li> <li>• “Integrate C Functions Using Legacy Code Tool” in the Simulink documentation</li> <li>• “Integrate External Code Using Legacy Code Tool” on page 14-28</li> </ul>
5	You want ease of use with basic flexibility to control what code gets generated, typically	Use the S-Function Builder to generate the S-function and TLC files; optionally, you can	“Build S-Functions Automatically” in the Simulink documentation

	<b>If...</b>	<b>Then...</b>	<b>For More Information, See...</b>
	for mixed discrete and continuous-time applications; programming experience is limited or the external code requires a Fixed-Point block interface	fine tune the generated files manually to better meet application needs	

If you must control how code generation technology declares, stores, and represents data in generated code, you can do so by designing (creating) and applying custom storage classes (CSCs) if you have an Embedded Coder license. For information on CSCs see the examples `rtwdemo_cscpredef`, `rtwdemo_importstruct`, and `rtwdemo_advsc` and “Custom Storage Classes” in the Embedded Coder documentation.

## Integrate Fortran Code

The following diagram shows that to integrate external Fortran code as reusable algorithmic components you must integrate the code by writing an S-function and corresponding TLC file.

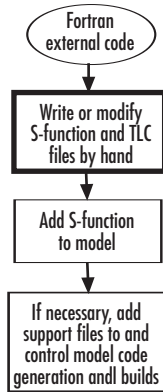

For information, see “Fortran S-Function Examples” and “Fortran S-Functions”

## Integration Considerations for Reusable Algorithmic Components

---

**Note** Solutions marked with *EC only* require an Embedded Coder license.

---

If...	Consider...	For More Information, See...
Generated code must use math functions and operators that are consistent with imported external code	<i>EC only</i> —Using the code replacement library (CRL) API, Code Replacement Tool, and Code Replacement Viewer to create, examine, validate, and register function and operator replacement tables	<ul style="list-style-type: none"> <li>• <code>rtwdemo_crl_script</code></li> <li>• “Introduction to Code Replacement Libraries” in the Embedded Coder documentation</li> </ul>
Generated code must share data with imported external code	Using data creation and management technologies, such as Simulink data objects, alias and numeric data types, and data type replacement to match data type, formatting, and storage that is consistent with that used by the imported external code	<ul style="list-style-type: none"> <li>• “Data Types”</li> <li>• “Data Representation”</li> </ul>
Style and format of identifiers in generated code must be consistent with style and format applied in imported external code	In the Configuration Parameters dialog box, on the <b>Symbols</b> pane, configure identifier naming for the generated code	<ul style="list-style-type: none"> <li>• <code>rtwdemo_symbols</code></li> <li>• <code>rtwdemo_namerules</code></li> <li>• “Configure Generated Identifiers” on page 9-73 and “Configure Generated Identifiers in Embedded System Code” in the Embedded Coder documentation</li> </ul>

<b>If...</b>	<b>Consider...</b>	<b>For More Information, See...</b>
Use of comments in generated code must match the use of comments in imported external code	In the Configuration Parameters dialog box, on the <b>Comments</b> pane, configure comments for the generated code	<ul style="list-style-type: none"><li>• <code>rtwdemo_comments</code></li><li>• “Configure Code Comments” on page 9-72 and “Configure Code Comments in Embedded System Code” in the Embedded Coder documentation</li></ul>
Style of code, such as style and usage of parentheses, must be match the style used in imported external code	<i>EC only</i> —In the Configuration Parameters dialog box, on the <b>Code Style</b> pane, configure the style for the generated code	<ul style="list-style-type: none"><li>• <code>rtwdemo_parentheses</code></li><li>• “Control Code Style” in the Embedded Coder documentation</li></ul>

## **Deploy Algorithm Code Within a Target Environment**

Code generation technology can generate a single set of application source files from an algorithm model and integrated external C or C++ code that supports the target environment hardware. For example, you might have a working device driver that you want to integrate with algorithmic code that has to read data from and write data to the I/O device the driver supports. Typically, a deployed model algorithm calls out to the external code.

The following diagram identifies common characteristics or requirements for a target environment in which generated algorithm code might be deployed and recommends solutions. The table that follows the diagram provides more detail. Collectively, the diagram and table help you choose the best solution for your application and find more related information.

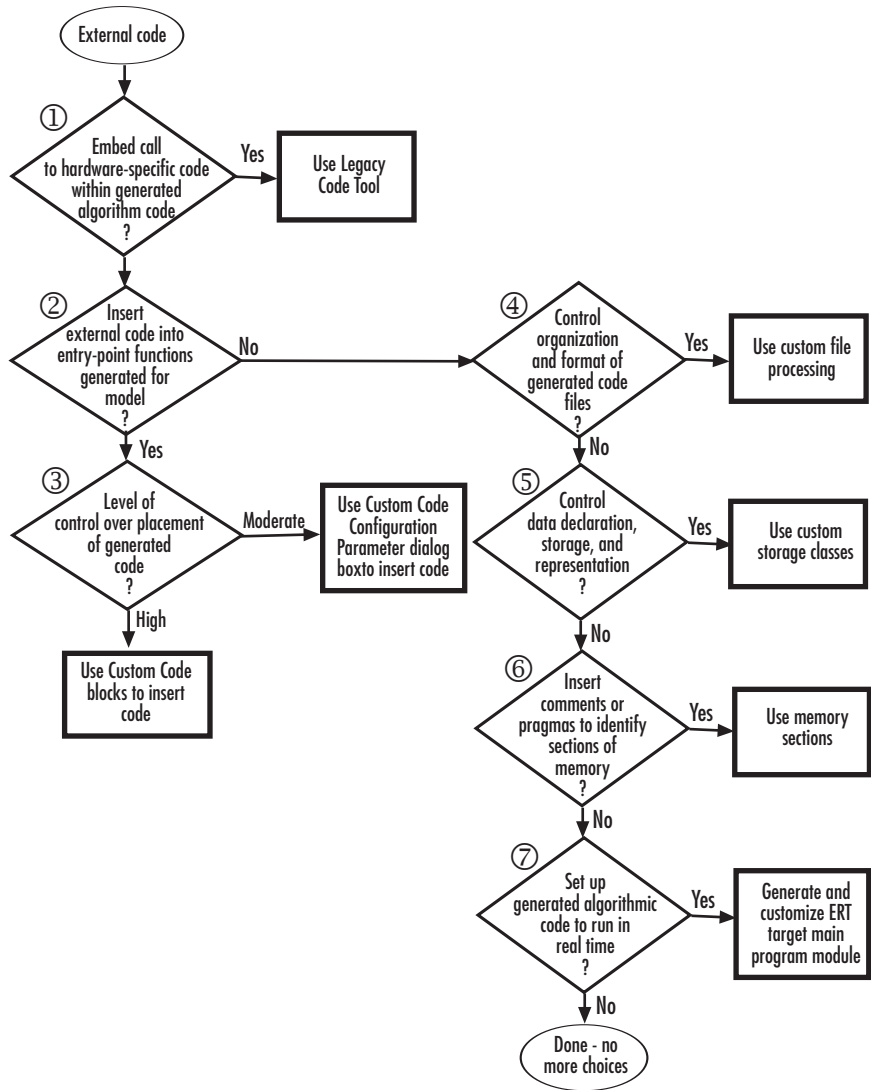

**Note** Solutions marked with *EC only* require an Embedded Coder license.

	<b>If You Need To...</b>	<b>Then...</b>	<b>For More Information, See...</b>
1	Embed a call to hardware-specific code, such as a device driver, within generated algorithm code	Use the Legacy Code Tool	<ul style="list-style-type: none"> <li>• “Integrate Device Drivers” on page 24-135</li> <li>• “Integrate C Functions Using Legacy Code Tool” in the Simulink documentation</li> <li>• “Integrate External Code Using Legacy Code Tool” on page 14-28</li> </ul>
2	Insert target-specific C or C++ code into entry-point functions that Simulink Coder generates for a model with a high level of control over code placement; for example, inserting startup, initialization, or termination code	Use Custom Code blocks	<ul style="list-style-type: none"> <li>• <code>rtwdemo_slcustcode</code></li> <li>• “Insert Custom Code Blocks” on page 14-36</li> </ul>
3	Insert application-specific C or C++ code—near the top of the generated source code or header file or inside the model initialization or termination function—or files for the build process—source, header, library—for the external code	Configure files and data for the external code environment by entering code and file specifications for parameters on the <b>Code Generation &gt; Interface</b> pane of the Configuration Parameters dialog box	<ul style="list-style-type: none"> <li>• Integrating the Generated Code into the External Environment</li> <li>• “Configure Model for External Code Integration” on page 14-33</li> </ul>



	<b>If You Need To...</b>	<b>Then...</b>	<b>For More Information, See...</b>
4	Control the organization and format of code files generated for a model—for example, placement of code in sections, inclusion of banners, calls to generated entry-point functions, generation of a main program module	<i>EC only</i> —Use the custom file processing components—code generation template (CGT) files, code template API, and custom file processing (CFP) templates (the API and CFP templates require TLC programming knowledge)	<ul style="list-style-type: none"> <li>• <code>rtwdemo_codetemplate</code></li> <li>• “Customize Code Organization and Format” in the Embedded Coder documentation</li> </ul>
5	Control how the Simulink Coder product declares, stores, and represents signals, tunable parameters, block states, and data objects in generated code	<i>EC only</i> — Design (create) and apply custom storage classes	<ul style="list-style-type: none"> <li>• <code>rtwdemo_cscpredef</code></li> <li>• <code>rtwdemo_importstruct</code></li> <li>• <code>rtwdemo_advsc</code></li> <li>• “Custom Storage Classes” in the Embedded Coder documentation</li> </ul>
6	Insert comments or pragmas in generated code to identify memory for custom storage classes or model- or subsystem-level functions and internal data	<i>EC only</i> — Use the memory section capability	<ul style="list-style-type: none"> <li>• <code>rtwdemo_memsec</code></li> <li>• “About Memory Sections”</li> </ul>
7	Set up generated algorithmic code to run in real time—within the context of a real-time operating system (RTOS) or on hardware that is not running an operating system (bare board)	<i>EC only</i> —Generate and customize an ERT target main (harness) program module ( <code>ert_main.c</code> or <code>ert_main.cpp</code> ) for the model	<ul style="list-style-type: none"> <li>• “Deployment”</li> <li>• “Standalone Programs (No Operating System)”</li> </ul>

## Export Generated Algorithm Code for Embedded Applications

You have multiple options for configuring and preparing a model or subsystem so that you can plug its generated source code into an existing external code base.

Scan the first column of the following table to identify tasks that apply to the algorithm code you want to export. For each task that applies, the information in the corresponding row describes how to achieve the goal, using code generation technology.

---

**Note** Solutions marked with *EC only* require an Embedded Coder license.

---

If You Need To...	Then...	For More Information, See...
Insert C or C++ code into specific entry-point functions that Simulink Coder generates for interfacing with the external code	Use Custom Code blocks	<ul style="list-style-type: none"> <li>• <code>rtwdemo_slcstcode</code></li> <li>• “Insert Custom Code Blocks” on page 14-36</li> </ul>
Pass composite data	Represent the data in the model as a vector or bus	<ul style="list-style-type: none"> <li>• <code>rtwdemo_scalarrep</code></li> <li>• <code>rtwdemo_slbus</code></li> <li>• “Composite Signals”</li> <li>• “Optimize Code Generated for Vector Assignments” on page 19-6 and “Buses”</li> </ul>
Read from or write to a specific region or area of memory	<i>EC only</i> — Set up a Data Store Memory block in the model to represent the area of memory and define the area with the built-in advanced custom storage class (CSC) <code>GetSet</code>	<ul style="list-style-type: none"> <li>• “Increase Code Efficiency With <code>GetSet</code> CSC”</li> <li>• “<code>GetSet</code> Custom Storage Classes” in the Embedded Coder documentation</li> </ul>

If You Need To...	Then...	For More Information, See...
Generate a C++ class interface—encapsulated model data (properties) and model entry-point functions (methods)—to the model code	<i>EC only</i> — Configure and generate the C++ encapsulation interface in the Configuration Parameters dialog box or programmatically in the MATLAB command window or with a script	<ul style="list-style-type: none"> <li>• “Simple Use of C++ Encapsulation Control”</li> <li>• “C++ Encapsulation Interface Control” in the Embedded Coder documentation</li> </ul>
Control how Embedded Coder generates function prototypes — arguments, argument order, and data types—for a model (for example, so the prototypes match the external code)	<i>EC only</i> — Configure function prototypes for the model by clicking the <b>Configure Model Functions</b> button on the <b>Code Generation &gt; Interface</b> pane of the Configuration Parameters dialog box and entering data in the Model Interface dialog box; alternatively, configure the function prototypes programmatically in the MATLAB command window or with a script	<ul style="list-style-type: none"> <li>• “Sample Procedure for Configuring Function Prototypes”</li> <li>• “Function Prototype Control” in the Embedded Coder documentation</li> </ul>
Insert application-specific C or C++ code—near the top of the generated source code or header file or inside the model initialization or termination function—or files for the build process—source, header,	Configure files and data for the external code environment by entering code and file specifications for parameters on the <b>Code Generation &gt; Interface</b> pane of the Configuration Parameters dialog box	<ul style="list-style-type: none"> <li>• Integrating the Generated Code into the External Environment</li> <li>• “Configure Model for External Code Integration” on page 14-33</li> </ul>

If You Need To...	Then...	For More Information, See...
library—for the external code		
Generate code, which is to be integrated with an existing C code base, for a function-call or virtual subsystem	<i>EC only</i> — Review and adjust for exported subsystem requirements, configure the parent model to use an ERT target, and right-click build the subsystem block using the <b>C/C++ Code &gt; Export Functions</b> menu item	<ul style="list-style-type: none"> <li>• “Techniques for Exporting Function-Call Subsystems”</li> <li>• <code>rtwdemo_export_functions</code></li> <li>• “Export Function-Call Subsystems” in the Embedded Coder documentation</li> </ul>

## Export Algorithm Executables for System Simulation

If you have an Embedded Coder license, you can use an ERT shared library target (`shrlib.tlc`) to build a Windows dynamic link library (`.dll`) or a UNIX shared object (`.so`) file from a model. An application, which runs on a Windows or a UNIX system, can then load the shared library file. You can upgrade a shared library without having to recompile applications that use it.

Uses of shared library files include:

- Adding a software component to an application for system simulation
- Reusing off-the-shelf software modules among applications on a host system
- Hiding source code (intellectual property) for software shared with a vendor

For an example, see `rtwdemo_shrlib`. For more information, see “Shared Object Libraries” in the Embedded Coder documentation.

## Modify External Code for Language Compatibility

If you need to integrate external C code with generated C++ code or vice versa, you must modify your external code to be language compatible with the generated code. Options for making the code language compatible include:

- Writing or rewriting the legacy or custom code in the same language as the generated code.
- If the generated code is in C++ and your legacy or custom code is in C, for each C function, create a header file that prototypes the function, using the following format:

```
#ifdef __cplusplus
extern "C" {
#endif
int my_c_function_wrapper();
#ifdef __cplusplus
}
#endif
```

The prototype serves as a function wrapper. If your compiler supports C++ code, the value `__cplusplus` is defined. The linkage specification `extern "C"` specifies C linkage with no name mangling.

- If the generated code is in C and your legacy or custom code is in C++, include an `extern "C"` linkage specification in each `.cpp` file. For example, the following shows a portion of C++ code in the file `my_func.cpp`:

```
extern "C" {

int my_cpp_function()
{
    ...
}
}
```

## Automate S-Function Generation

The **Generate S-function** feature automates the process of generating an S-function from a subsystem. In addition, the **Generate S-function** feature presents a display of parameters used within the subsystem, and lets you declare selected parameters tunable.

As an example, consider `SourceSubsys`, the same subsystem illustrated in the example “Create S-Function Blocks from a Subsystem” on page 12-37. The objective is to automatically extract `SourceSubsys` from the model and build an S-Function block from it, as in the previous example. In addition, the workspace variable `K`, which is the gain factor of the Gain block within `SourceSubsys` (as shown in the Gain block parameter dialog box below), is declared and generated as a tunable variable.

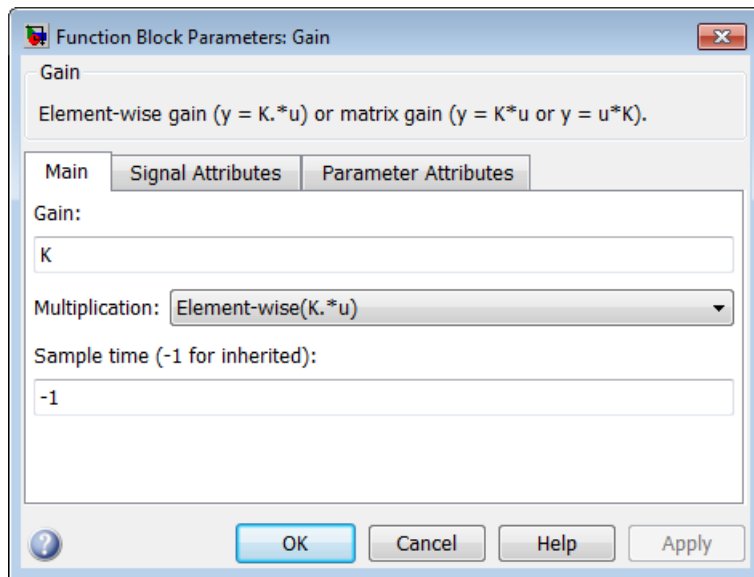

To auto-generate an S-function from `SourceSubsys` with tunable parameter `K`,

- 1 With the `SourceSubsys` model open, click the subsystem to select it.
- 2 From the **Code** menu, select **C/C++ Code > Generate S-Function**. This menu item is enabled when a subsystem is selected in the current model.

Alternatively, you can right-click the subsystem and select **C/C++ Code > Generate S-Function** from the subsystem block's context menu.

- 3** The **Generate S-Function** window is displayed (see the next figure). This window shows all variables (or data objects) that are referenced as block parameters in the subsystem, and lets you declare them as tunable.

The upper pane of the window displays three columns:

- **Variable Name:** name of the parameter.
- **Class:** If the parameter is a workspace variable, its data type is shown. If the parameter is a data object, its name and class is shown
- **Tunable:** Lets you select tunable parameters. To declare a parameter tunable, select the check box. In the next figure, the parameter K is declared tunable.

When you select a parameter in the upper pane, the lower pane shows all the blocks that reference the parameter, and the parent system of each such block.

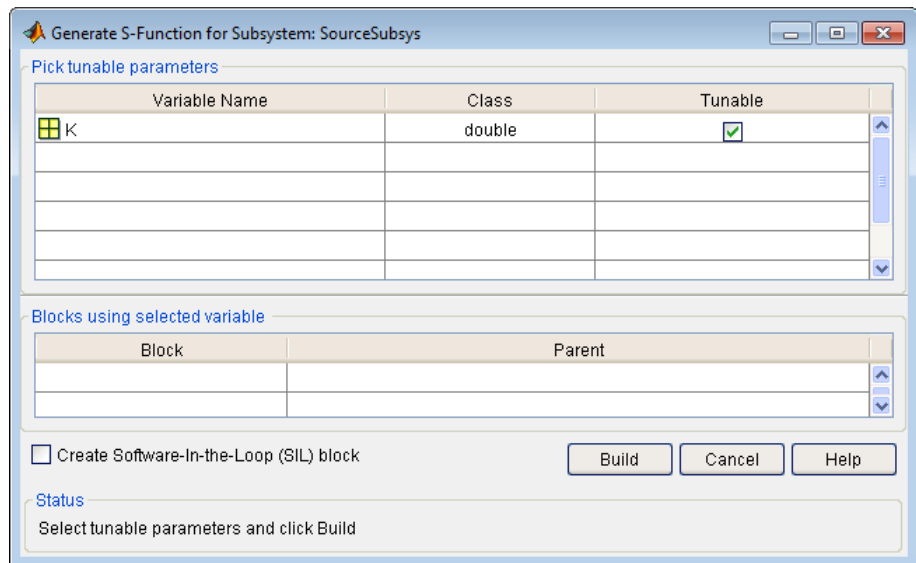

**Generate S-Function Window**



- 4 If you have installed the Embedded Coder product, and if the subsystem does not have a continuous sample time, the **Create Software In the Loop (SIL) block** check box is available, as shown above. Otherwise, it is appears dimmed. When **Create Software In the Loop (SIL) block** is selected, the build process generates a wrapper S-function by using the Embedded Coder product. See “Generate S-Function Wrappers” in the Embedded Coder documentation for more information.
- 5 After selecting tunable parameters, click the **Build** button. This initiates code generation and compilation of the S-function, using the S-function target. The **Create New Model** option is automatically enabled.
- 6 The build process displays status messages in the MATLAB Command Window. When the build completes, the tunable parameters window closes, and a new untitled model window opens.

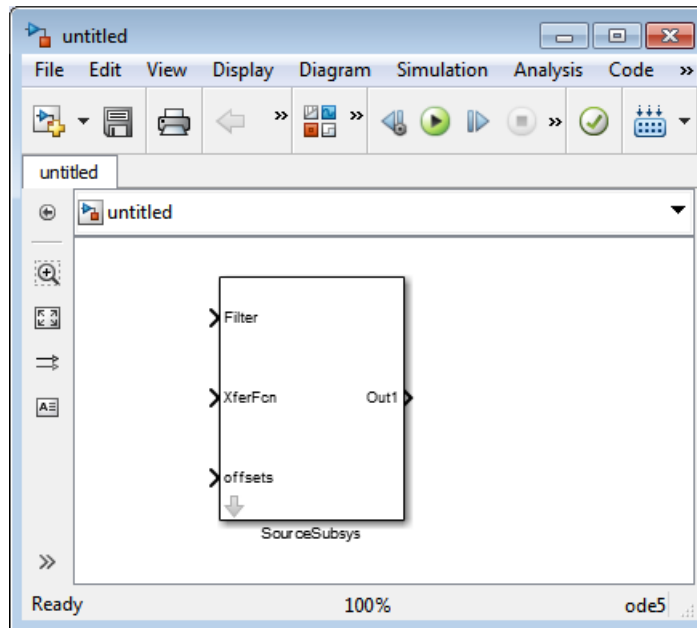

- 7 The model window contains an S-Function block with the same name as the subsystem from which the block was generated (in this example, SourceSubsys). Optionally, you can save the generated model containing the generated block.

**8** The generated code for the S-Function block is stored in the current working folder. The following files are written to the top level folder:

- *subsys\_sf.c* or *.cpp*, where *subsys* is the subsystem name (for example, *SourceSubsys\_sf.c*)
- *subsys\_sf.h*
- *subsys\_sf.mexext*, where *mexext* is a platform-dependent MEX-file extension (for example, *SourceSubsys\_sf.mexw32*)

The source code for the S-function is written to the subfolder *subsys\_sfcn\_rtw*. The top-level *.c* or *.cpp* file is a stub file that simply contains an include directive that you can use to interface other C/C++ code to the generated code.

---

**Note** For a list of files required to deploy your S-Function block for simulation or code generation, see “Required Files for S-Function Deployment” on page 12-36.

---

**9** The generated S-Function block has inports and outports whose widths and sample times correspond to those of the original model.

The following code, from the *mdlOutputs* routine of the generated S-function code (in *SourceSubsys\_sf.c*), shows how the tunable variable *K* is referenced by using calls to the MEX API.

```
static void mdlOutputs(SimStruct *S, int_T tid)
...

/* Gain: '<S1>/Gain' incorporates:
 * Sum: '<S1>/Sum'
 */
rtb_Gain_n[0] = (rtb_Product_p + (((const
real_T**)ssGetInputPortSignalPtrs(S, 2))[0]))) * ((real_T
*)(mxGetData(K(S))));
rtb_Gain_n[1] = (rtb_Product_p + (((const
real_T**)ssGetInputPortSignalPtrs(S, 2))[1]))) * ((real_T
*)(mxGetData(K(S))));
```

---

**Notes**

- In automatic S-function generation, the **Use Value for Tunable Parameters** option is always set to its default value (off).
  - A MEX S-function wrapper must only be used in the MATLAB version in which the wrapper is created.
-

## Integrate External Code Using Legacy Code Tool

In this section...
“Legacy Code Tool and Code Generation” on page 14-28
“Generate Inlined S-Function Files for Code Generation” on page 14-29
“Apply Code Style Settings to Legacy Functions” on page 14-30
“Address Dependencies on Files in Different Locations” on page 14-31
“Deploy S-Functions for Simulation and Code Generation” on page 14-32

### Legacy Code Tool and Code Generation

You can use the Simulink Legacy Code Tool to automatically generate fully inlined C MEX S-functions for legacy or custom code that is optimized for embedded components, such as device drivers and lookup tables, that call existing C or C++ functions.

---

**Note** The Legacy Code Tool can interface with C++ functions, but not C++ objects. For a work around so that the tool can interface with C++ objects, see “Legacy Code Tool Limitations” in the Simulink documentation.

---

You can use the tool to:

- Compile and build the generated S-function for simulation.
- Generate a masked S-Function block that is configured to call the existing external code.

If you want to include these types of S-functions in models for which you intend to generate code, you must use the tool to generate a TLC block file. The TLC block file specifies how the generated code for a model calls the existing C or C++ function.

If the S-function depends on files in folders other than the folder containing the S-function dynamically loadable executable file, and you want to maintain those dependencies for building a model that includes the S-function, use the

tool to also generate an `rtwmakecfg.m` file for the S-function. For example, for some applications, such as custom targets, you might want to locate files in a target-specific location. The Simulink Coder build process looks for the generated `rtwmakecfg.m` file in the same folder as the S-function's dynamically loadable executable and calls the `rtwmakecfg` function if the software finds the file.

For more information, see “Integrate C Functions Using Legacy Code Tool” in the Simulink documentation.

## Generate Inlined S-Function Files for Code Generation

Depending on your application's code generation requirements, to generate code for a model that uses the S-function, you can choose to do either of the following:

- Generate one `.cpp` file for the inlined S-function. In the Legacy Code Tool data structure, set the value of the `Options.singleCPPMexFile` field to `true` before generating the S-function source file from your existing C function. For example:

```
def.Options.singleCPPMexFile = true;
legacy_code('sfcn_cmex_generate', def);
```

- Generate a source file and a TLC block file for the inlined S-function. For example:

```
def.Options.singleCPPMexFile = false;
legacy_code('sfcn_cmex_generate', def);
legacy_code('sfcn_tlc_generate', def);
```

### singleCPPMexFile Limitations

You cannot set the `singleCPPMexFile` field to `true` if

- `Options.language='C++'`
- You use one of the following Simulink objects with the `IsAlias` property set to `true`:
  - `Simulink.Bus`

- `Simulink.AliasType`
- `Simulink.NumericType`
- The Legacy Code Tool function specification includes a `void*` or `void**` to represent scalar work data for a state argument
- `HeaderFiles` field of the Legacy Code Tool structure specifies multiple header files

### Apply Code Style Settings to Legacy Functions

To apply the model configuration parameters for code style to a legacy function:

- 1 Initialize the Legacy Code Tool data structure. For example:

```
def = legacy_code('initialize');
```

- 2 In the data structure, set the value of the `Options.singleCPPMexFile` field to `true`. For example:

```
def.Options.singleCPPMexFile = true;
```

To verify the setting, enter:

```
def.Options.singleCPPMexFile
```

### singleCPPMexFile Limitations

You cannot set the `singleCPPMexFile` field to `true` if

- `Options.language='C++'`
- You use one of the following Simulink objects with the `IsAlias` property set to `true`:
  - `Simulink.Bus`
  - `Simulink.AliasType`
  - `Simulink.NumericType`

- The Legacy Code Tool function specification includes a `void*` or `void**` to represent scalar work data for a state argument
- `HeaderFiles` field of the Legacy Code Tool structure specifies multiple header files

## Address Dependencies on Files in Different Locations

By default, the Legacy Code Tool assumes that all files on which an S-function depends reside in the same folder as the dynamically loadable executable file for the S-function. If your S-function depends on files that reside elsewhere and you are using the Simulink Coder template makefile build process, you must generate an `rtwmakecfg.m` file for the S-function. For example, it is likely that you need to generate this file if your Legacy Code Tool data structure defines compilation resources as path names.

To generate the `rtwmakecfg.m` file, call the `legacy_code` function with `'rtwmakecfg_generate'` as the first argument, and the name of the Legacy Code Tool data structure as the second argument.

```
legacy_code('rtwmakecfg_generate', lct_spec);
```

If you use multiple registration files in the same folder and generate an S-function for each file with a single call to `legacy_code`, the call to `legacy_code` that specifies `'rtwmakecfg_generate'` must be common to all registration files. For more information, see “Handling Multiple Registration Files” in the Simulink documentation

For example, if you define `defs` as an array of Legacy Code Tool structures, you call `legacy_code` with `'rtwmakecfg_generate'` once.

```
defs = [defs1(:);defs2(:);defs3(:)];  
legacy_code('rtwmakecfg_generate', defs);
```

For more information, see “Build Support for S-Functions” on page 14-120.

## Deploy S-Functions for Simulation and Code Generation

You can deploy the S-functions that you generate with the Legacy Code Tool so that other people can use them. To deploy an S-function for simulation and code generation, share the following files:

- Registration file
- Compiled dynamically loadable executable
- TLC block file
- `rtwmakecfg.m` file
- All header, source, and include files on which the generated S-function depends

Users of the deployed files must be aware that:

- Before using the deployed files in a Simulink model, they must add the folder that contains the S-function files to the MATLAB path.
- If the Legacy Code Tool data structure registers any required files as absolute paths and the location of the files changes, they must regenerate the `rtwmakecfg.m` file.



## Configure Model for External Code Integration

Configure a model using the **Custom Code** pane such that the code generator includes external code such as headers, files, and functions. You can also include additional files and paths in the build process.

To...	Select...
Insert custom code near the top of the generated <i>model.c</i> or <i>model.cpp</i> file, outside of any function	<b>Source file</b> and enter the custom code to insert.
Insert custom code near the top of the generated <i>model.h</i> file	<b>Header file</b> and enter the custom code to insert.
Insert custom code inside the model's initialize function in the <i>model.c</i> or <i>model.cpp</i> file	<b>Initialize function</b>
Insert custom code inside the model's terminate function in the <i>model.c</i> or <i>model.cpp</i> file.	<b>Terminate function</b> and enter the custom code to insert. Also select the <b>Terminate function required</b> parameter on the <b>Interface</b> pane.
Add include folders, which contain header files, to the build process	<b>Include directories</b> and enter the absolute or relative paths to the folders. If you specify relative paths, the paths must be relative to the folder containing your model files, not relative to the build folder. The order in which you specify the folders is the order in which they are searched for header, source, and library files.

To...	Select...
<p>Add source files to be compiled and linked</p>	<p><b>Source files</b> and enter the full paths or just the file names for the files. Enter just the file name if the file is in the current MATLAB folder or in one of the include folders. For each additional source that you specify, the build process expands a generic rule in the template makefile for the folder in which the source file is found. For example, if a source file is found in folder <code>inc</code>, the build process adds a rule similar to the following:</p> <pre data-bbox="654 586 1248 644">%.obj: builddir\inc\%.c     \$(CC) -c -Fo\$(@F) \$(CFLAGS) \$&lt;</pre> <p>The build process adds the rules in the order you list the source files.</p>
<p>Add libraries to be linked</p>	<p><b>Libraries</b> and enter the full paths or just the file names for the libraries. Enter just the file name if the library is located in the current MATLAB folder or in one of the include folders.</p>
<p>Use the same custom code settings as those specified for simulation of MATLAB Function blocks, Stateflow charts, and Truth Table blocks</p>	<p><b>Use the same custom code settings as Simulation Target</b></p> <hr/> <p><b>Note</b> This option refers to the <b>Simulation Target</b> pane in the Configuration Parameters dialog box.</p> <hr/>
<p>Enable a library model to use custom code settings unique from the parent model to which the library is linked</p>	<p><b>Use local custom code settings (do not inherit from main model)</b></p> <hr/> <p><b>Note</b> This option is available only for library models that contain MATLAB Function blocks, Stateflow charts, or Truth Table blocks.</p> <hr/>

If you are including a header file, in your custom header file add `#ifndef` code. This avoids multiple inclusions. For example, in `rtwtypes.h` the following `#include` guards are added:

```
#ifndef RTW_HEADER_rtwtypes_h_
#define RTW_HEADER_rtwtypes_h_
...
#endif /* RTW_HEADER_rtwtypes_h_ */
```

---

**Note** Custom code that you include in a configuration set is ignored when building S-function targets, accelerated simulation targets, and model reference simulation targets.

---

For more information about **Custom Code** pane parameters, see “Code Generation Pane: Custom Code”.

## Insert Custom Code Blocks

The following sections explain how to use blocks in the Custom Code block library to insert custom code into the code generated for a model. This chapter includes the following topics:

In this section...
“Custom Code Library” on page 14-36
“Embed Custom Code Directly Into MdlStart Function” on page 14-40
“Custom Code in Subsystems” on page 14-43
“Preserve User Files in Build Folder” on page 14-44

### Custom Code Library

The Custom Code library contains blocks that enable you to insert your own C or C++ code into specific functions within code generated by the Simulink Coder product for root models and subsystems. These blocks are a superset of code customization capabilities built into the **Custom Code** Configuration Parameters dialog box, and provide greater flexibility in terms of code placement than the controls on the dialog box.

The Custom Code library is part of the Simulink Coder library. You can access the Simulink Coder library by using the Simulink Library Browser. You can access Custom Code blocks by using the Simulink Coder library or by entering the MATLAB command `rtwlib` and then double-clicking the Custom Code Library block within it. Alternatively, you can enter the command `custcode`.

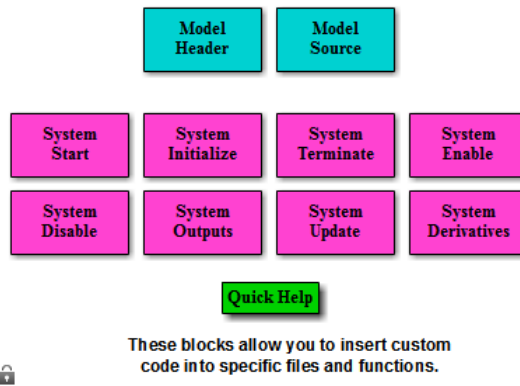

---

**Note** If you need to integrate custom C++ code with generated C code or vice versa, see “Modify External Code for Language Compatibility” on page 14-22.

---

All Custom Code blocks except for Model Header and Model Source can be dragged into either root models or atomic subsystems. Model Header and Model Source blocks can only be placed in root models.

---

**Note** You can use models containing Custom Code blocks as submodels (models referenced by Model blocks). However, when simulation targets for submodels are generated, all Custom Code blocks within them are ignored. On the other hand, when submodel code is generated to create Simulink Coder targets, custom code is included and is compiled in the generated code.

---

The Custom Code library contains ten blocks that insert custom code into the generated model files and functions. You can view the blocks either by

- Expanding the Custom Code node (under Simulink Coder library) in the Simulink Library Browser
- Right-clicking the Custom Code sublibrary icon in the right pane of the Simulink Library Browser

The latter method opens the window shown in the previous section.

The two blocks on the top row contain text fields for inserting custom code at the top and bottom of

- *model.h* — Model Header File block
- *model.c* or *model.cpp* — Model Source File block

Each block contains two fields, in which you type or paste code and comments:

- Top of Model Source/Header
- Bottom of Model Source/Header

The next figure shows the Model Source block dialog box.

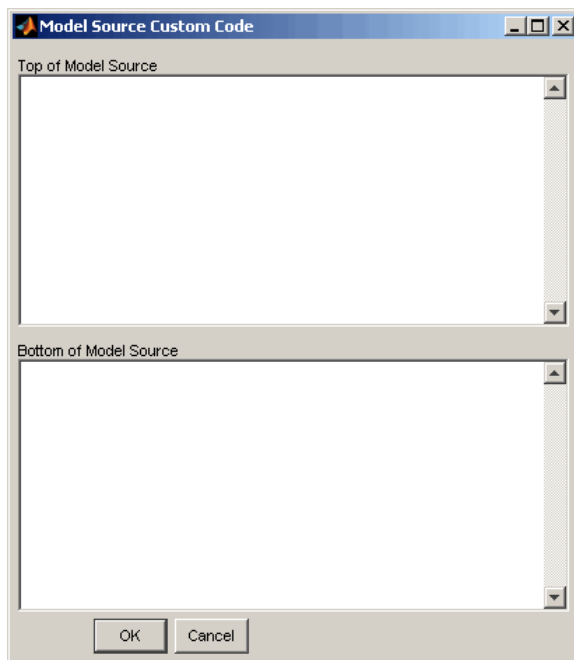

The eight function blocks in the second and third rows contain text fields to insert custom code sections at the top and bottom of these designated model functions:

- SystemStart — System Start function block
- SystemInitialize — System Initialize function block
- SystemTerminate — System Terminate function block
- SystemEnable — System Enable function block
- SystemDisable — System Disable function block
- SystemOutputs — System Outputs function block
- SystemUpdate — System Update function block
- SystemDerivatives — System Derivatives function block

Each of these blocks provides a System Outputs Function Custom Code dialog box that contains three fields:

- Declaration code
- Execution code
- Exit code

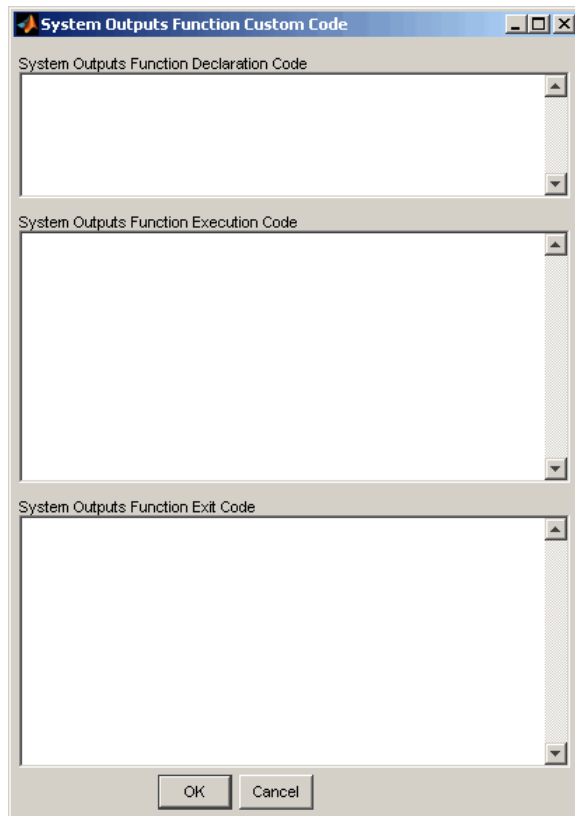

## Embed Custom Code Directly Into Md1Start Function

The following example uses a System Start Function block to introduce code into the Md1Start function. The next figure shows a simple model with the System Start Function block inserted.



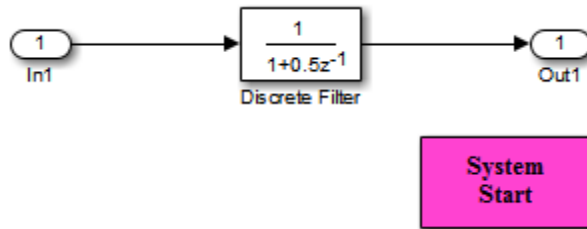

Double-clicking the System Start Function block opens the System Start Function Custom Code dialog box.

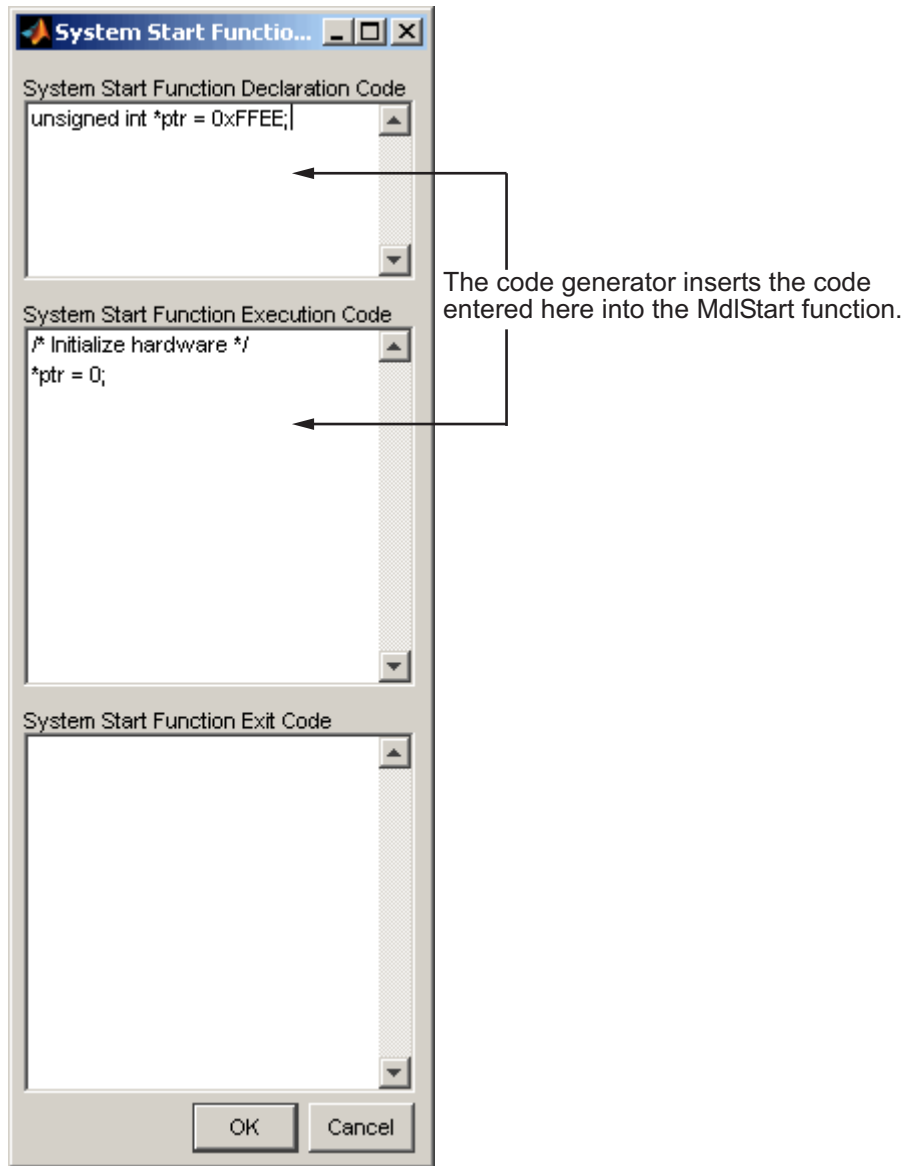

You can insert custom code into any or all of the available text fields.

The code below is the MdlStart function for this example (mymodel).

```
void MdlStart(void)
{
    {
        {
            /* user code (Start function Header) */
            /* System '<Root>' */
            unsigned int *ptr = 0xFFEE;

            /* user code (Start function Body) */
            /* System '<Root>' */
            /* Initialize hardware */
            *ptr = 0;
        }
    }

    MdlInitialize();
}
```

The custom code entered in the System Start Function Custom Code dialog box is embedded directly in the generated code. Each block of custom code is tagged with a comment such as

```
/* user code (Start function Header) */
```

## Custom Code in Subsystems

The location of a Custom Code block in your model determines the location of the code it contains. You can use System Custom Code blocks either at root level or within atomic subsystems; the code is local to the subsystem in which you place the blocks. For example, the System Outputs block places code in `mdlOutputs` when the code block resides in the root model. If the System Outputs block resides in a triggered or enabled subsystem, however, the code is placed in the subsystem's `Outputs` function.

The ordering for a triggered or enabled system is

- 1 Output entry
- 2 Output exit

**3** Update entry

**4** Update exit

---

**Note** If a root model or atomic subsystem does not need to generate a function for which a Custom Code block has been supplied, either the code in the block is not used or an error is generated. There is no diagnostic setting to control this. To eliminate the error, remove the Custom Code block.

---

## Preserve User Files in Build Folder

Prior to Release 13 (Version 5.0), the Simulink Coder product did not delete any .c or .h files that you might have placed in the build folder when rebuilding targets. From Release 13 onward, all foreign source files are by default deleted during builds, but can be preserved by following the guidelines given below.

If you put a .c/.cpp or .h source file in a build folder, and you want to prevent the Simulink Coder product from deleting it during the TLC code generation process, insert the string `target specific file` in the first line of the .c/.cpp or .h file. For example,

```
/* COMPANY-NAME target specific file
 *
 * This file is created for use with the
 * COMPANY-NAME target.
 * It is used for ...
 */
...
```

Make sure you spell the string “target specific file” as shown in the preceding example, and that the string is in the first line of the source file. Other text can appear before or after this string.

In addition to preserving them, flagging user files in this manner prevents postprocessing them to indent them along with generated source files. Auto-indenting occurred in previous releases to build folder files with names having the pattern `model_*.c/.cpp` (where \* could be any string). The

indenting is harmless, but can cause differences to be detected by source control software that might trigger unnecessary updates.

## Insert S-Function Code

### In this section...

“About S-Functions and Code Generation” on page 14-46

“Write Noninlined S-Functions” on page 14-52

“Write Wrapper S-Functions” on page 14-54

“Write Fully Inlined S-Functions” on page 14-64

“Write Fully Inlined S-Functions with mdlRTW Routine” on page 14-65

“Guidelines for Writing Inlined S-Functions” on page 14-91

“Write S-Functions That Support Expression Folding” on page 14-91

“S-Functions That Specify Port Scope and Reusability” on page 14-105

“S-Functions That Specify Sample Time Inheritance Rules” on page 14-111

“S-Functions That Support Code Reuse” on page 14-113

“S-Functions for Multirate Multitasking Environments” on page 14-113

“Build Support for S-Functions” on page 14-120

### About S-Functions and Code Generation

This chapter describes how to create S-functions that work seamlessly with Simulink Coder code generation. It begins with basic concepts and concludes with an example of how to create a highly optimized direct-index lookup table S-Function block.

This chapter assumes that you understand the following concepts:

- Level 2 S-functions
- Target Language Compiler (TLC) scripting
- How the Simulink Coder software generates and builds C/C++ code

---

**Note** When this chapter refers to actions performed by the Target Language Compiler, including parsing, caching, creating buffers, and so on, the name Target Language Compiler is spelled out fully. When referring to code written in the Target Language Compiler syntax, this chapter uses the abbreviation TLC.

---

---

**Note** The guidelines presented in this chapter are for Simulink Coder users. Even if you do not currently use the Simulink Coder code generator, you should follow the practices presented in this chapter when writing S-functions, especially if you are creating general-purpose S-functions.

---

### **Classes of Problems Solved by S-Functions**

S-functions help solve various kinds of problems you might face when working with the Simulink and Simulink Coder products. These problems include

- Extending the set of algorithms (blocks) provided by the Simulink and Simulink Coder products
- Interfacing legacy (hand-written) code with the Simulink and Simulink Coder products
- Interfacing to hardware through device driver S-functions
- Generating highly optimized code for embedded systems
- Verifying code generated for a subsystem as part of a Simulink simulation

S-functions are written using an application program interface (API) that allows you to implement generic algorithms in the Simulink environment with a great deal of flexibility. This flexibility cannot always be maintained when you use S-functions with the Simulink Coder code generator. For example, it is not possible to access the MATLAB workspace from an S-function that is used with the code generator. However, using the techniques presented in this chapter, you can create S-functions for most applications that work with the Simulink Coder generated code.

Although S-functions provide a generic and flexible solution for implementing complex algorithms in a Simulink model, the underlying API incurs overhead in terms of memory and computation resources. Most often the additional resources are acceptable for real-time rapid prototyping systems. In many cases, though, additional resources are unavailable in real-time embedded applications. You can minimize memory and computational requirements by using the Target Language Compiler technology provided with the Simulink Coder product to inline your S-functions. If you are producing an S-function for existing code, consider using the Simulink Legacy Code Tool.

### **Types of S-Functions**

The implementation of S-functions changes based on your requirements. This chapter discusses the typical problems that you may face and how to create S-functions for applications that need to work with the Simulink and Simulink Coder products. These are some (informally defined) common situations:

- 1** “I’m not concerned with efficiency. I just want to write one version of my algorithm and have it work in the Simulink and Simulink Coder products automatically.”
- 2** “I have a lot of hand-written code that I need to interface. I want to call my function from the Simulink and Simulink Coder products in an efficient manner.”

or said another way:

“I want to create a block for my blockset that will be distributed throughout my organization. I’d like it to be very maintainable with efficient code. I’d like my algorithm to exist in one place but work with both the Simulink and Simulink Coder products.”

- 3** “I want to implement a highly optimized algorithm in the Simulink and Simulink Coder products that looks like a built-in block and generates very efficient code.”

MathWorks products have adopted terminology for these different requirements. Respectively, the situations described above map to this terminology:

- 1** Noninlined S-function



## 2 Wrapper S-function

## 3 Fully inlined S-function

**Noninlined S-Functions.** A noninlined S-function is a C or C++ MEX S-function that is treated identically by the Simulink engine and Simulink Coder generated code. In general, you implement your algorithm once according to the S-function API. The Simulink engine and Simulink Coder generated code call the S-function routines (for example, `mdlOutputs`) during model execution.

Additional memory and computation resources are required for each instance of a noninlined S-Function block. However, this routine of incorporating algorithms into Simulink models and Simulink Coder applications is typical during the prototyping phase of a project where efficiency is not important. The advantage gained by forgoing efficiency is the ability to change model parameters and structures rapidly.

Writing a noninlined S-function does not involve any TLC coding. Noninlined S-functions are the default case for the Simulink Coder build process in the sense that once you build a MEX S-function in your model, there is no additional preparation prior to clicking **Build** in the **Code Generation** pane of the Configuration Parameters dialog box for your model.

Some restrictions exist concerning the names and locations of noninlined S-function files when generating makefiles. See “Write Noninlined S-Functions” on page 14-52.

**Wrapper S-Functions.** A wrapper S-function is ideal for interfacing hand-written code or a large algorithm that is encapsulated within a few procedures. In this situation, usually the procedures reside in modules that are separate from the MEX S-function. The S-function module typically contains a few calls to your procedures. Because the S-function module does not contain any parts of your algorithm, but only calls your code, it is referred to as a *wrapper S-function*.

In addition to the MEX S-function wrapper, you need to create a TLC wrapper that complements your S-function. The TLC wrapper is similar to the S-function wrapper in that it contains calls to your algorithm.

**Fully Inlined S-Functions.** For S-functions to work in the Simulink environment, some overhead code is generated. When the Simulink Coder software generates code from models that contain S-functions (without *sfunction.tlc* files), it embeds some of this overhead code in the generated code. If you want to optimize your real-time code and eliminate some of the overhead code, you must *inline* (or embed) your S-functions. This involves writing a TLC (*sfunction.tlc*) file that eliminates all overhead code from the generated code. The Target Language Compiler processes *sfunction.tlc* files to define how to inline your S-function algorithm in the generated code.

---

**Note** The term *inline* should not be confused with the C++ *inline* keyword. In Simulink Coder terminology, inline means to specify a text string in place of the call to the general S-function API routines (for example, `mdlOutputs`). For example, when a TLC file is used to inline an S-function, the generated code contains the C/ C++ code that would normally appear within the S-function routines and the S-function itself has been removed from the build process.

---

A fully inlined S-function builds your algorithm (block) into Simulink Coder generated code in a manner that is indistinguishable from a built-in block. Typically, a fully inlined S-function requires you to implement your algorithm twice: once for the Simulink model (C/C++ MEX S-function) and once for Simulink Coder code generation (TLC file). The complexity of the TLC file depends on the complexity of your algorithm and the level of efficiency you're trying to achieve in the generated code. TLC files vary from simple to complex in structure.

The Simulink Legacy Code Tool can automate the generation of a fully inlined S-function and a corresponding TLC file based on information that you register in a Legacy Code Tool data structure. For more information, see “Integrate C Functions Using Legacy Code Tool” in the Simulink Writing S-Functions documentation and “Integrate External Code Using Legacy Code Tool” on page 14-28.

### **Basic Files Required for Implementation**

This section briefly describes what files and functions you need to create noninlined, wrapper, and fully inlined S-functions.

- Noninlined S-functions require the C or C++ MEX S-function source code (*sfunction.c* or *sfunction.cpp*).
- Wrapper S-functions that inline a call to your algorithm (your C/C++ function) require an *sfunction.tlc* file.
- Fully inlined S-functions also require an *sfunction.tlc* file. Fully inlined S-functions produce the optimal code for a parameterized S-function. This is an S-function that operates in a specific mode dependent upon fixed S-function parameters that do not change during model execution. For a given operating mode, the *sfunction.tlc* file specifies the exact code that is generated to implement the algorithm for that mode. For example, the direct-index lookup table S-function at the end of this chapter contains two operating modes — one for evenly spaced *x-data* and one for unevenly spaced *x-data*.

Fully inlined S-functions might require the placement of the `mdlRTW` routine in your S-function MEX-file *sfunction.c* or *sfunction.cpp*. The `mdlRTW` routine lets you place information in *model.rtw*, the record file that specifies a model, and which the Simulink Coder code generator invokes the Target Language Compiler to process prior to executing *sfunction.tlc* when generating code.

Including a `mdlRTW` routine is useful when you want to introduce nontunable parameters into your TLC file. Such parameters are generally used to determine which operating mode is active in a given instance of the S-function. Based on this information, the TLC file for the S-function can generate highly efficient, optimal code for that operating mode.

## Guidelines for Writing S-Functions

- Use only C MEX S-functions with the Simulink Coder code generator. You cannot use Level-1 MATLAB language S-functions with Simulink Coder software.
- To inline an S-function, use the Legacy Code Tool. The Legacy Code Tool automatically generates fully inlined C MEX S-functions for legacy or custom code. In addition, the tool generates other files for compiling and building the S-function for simulation and generate a masked S-function block configured to call existing external code. For more information, see “Integrate C Functions Using Legacy Code Tool” in the Simulink

documentation and “Integrate External Code Using Legacy Code Tool” on page 14-28.

- If you are rapid prototyping, you might not have to inline an S-function.. If you choose not to inline the C MEX S-function, write the S-function, include it directly in the model, and let the Simulink Coder software generate the code. For more information, see “Write Noninlined S-Functions” on page 14-52.

## Write Noninlined S-Functions

- “About Noninlined S-Functions” on page 14-52
- “Guidelines for Writing Noninlined S-Functions” on page 14-52
- “Noninlined S-Function Parameter Type Limitations” on page 14-54

### About Noninlined S-Functions

Noninlined S-functions are identified by the *absence* of an `sfunction.tlc` file for your S-function. The filename varies depending on your platform. For example, on a 32-bit Microsoft Windows system, the file name would be `sfunction.mexw32`. Type `mexext` in the MATLAB Command Window to see which extension your system uses.

### Guidelines for Writing Noninlined S-Functions

- The MEX-file cannot call MATLAB functions.
- If the MEX-file uses functions in the MATLAB External Interface libraries, include the header file `cg_sfun.h` instead of `mex.h` or `simulink.c`. To handle this case, include the following lines at the end of your S-function:

```
#ifdef MATLAB_MEX_FILE /* Is this file being compiled as a MEX-file? */
#include "simulink.c" /* MEX-file interface mechanism */
#else
#include "cg_sfun.h" /* Code generation registration function */
#endif
```

- Use only MATLAB API function that the code generator supports, which include:

```
mxGetEps
mxGetInf
mxGetM
mxGetN
mxGetNaN
mxGetPr
mxGetScalar
mxGetString
mxIsEmpty
mxIsFinite
mxIsInf
```

- MEX library calls are not supported in generated code. To use such calls in MEX-file and not in the generated code, conditionalize the code as follows:

```
#ifdef MATLAB_MEX_FILE
#endif
```

- Use only full matrices that contain only real data.
- Do not specify a return value for calls to `mxGetString`. If you do specify a return value, the MEX-file will not compile. Instead, use the function's second input argument, which returns a pointer to a string.
- Make sure that the `#define s-function_name` statement is correct. The S-function name that you specify must match the S-function's filename.
- Use the data types `real_T` and `int_T` instead of `double` and `int`, if possible. The data types `real_T` and `int_T` are more generic and can be used in multiple environments.
- Provide the Simulink Coder build process with the names of all modules used to build the S-function. You can do this by using the Simulink Coder template make file or the `set_param` function. For example, suppose you build your S-function with the following command:

```
mex sfun_main.c sfun_module1.c sfun_module2.c
```

You can then use the following call to `set_param` to include all the required modules:

```
set_param(sfun_block, "SFunctionModules", "sfun_module1 sfun_module2')
```

## Noninlined S-Function Parameter Type Limitations

Parameters to noninlined S-functions can be of the following types only:

- Double precision
- Characters in scalars, vectors, or 2-D matrices

For more flexibility in the type of parameters you can supply to S-functions or the operations in the S-function, inline your S-function and consider using an `mdlRTW` S-function routine.

Use of other functions from the MATLAB `matrix.h` API or other MATLAB APIs, such as `mex.h` and `mat.h`, is not supported. If you call unsupported APIs from an S-function source file, compiler errors occur. See the file `matlabroot/rtw/c/src/rt_matrx.h(.c)` for details on supported MATLAB API functions.

If you use `mxGetPr` on an empty matrix, the function does not return `NULL`; rather, it returns a random value. Therefore, you should protect calls to `mxGetPr` with `mxIsEmpty`.

## Write Wrapper S-Functions

- “About Wrapper S-Functions” on page 14-54
- “MEX S-Function Wrapper” on page 14-55
- “TLC S-Function Wrapper” on page 14-59
- “The Inlined Code” on page 14-64

## About Wrapper S-Functions

This section describes how to create S-functions that work seamlessly with the Simulink and Simulink Coder products using the *wrapper* concept. This section begins by describing how to interface your algorithms in Simulink models by writing MEX S-function wrappers (*sfunction.mex*). It finishes with a description of how to direct the code generator to insert your algorithm into the generated code by creating a TLC S-function wrapper (*sfunction.tlc*).

## MEX S-Function Wrapper

Creating S-functions using an S-function wrapper allows you to insert C/C++ code algorithms in Simulink models and Simulink Coder generated code with little or no change to your original C/C++ function. A *MEX S-function wrapper* is an S-function that calls code that resides in another module. A *TLC S-function wrapper* is a TLC file that specifies how the code generator should call your code (the same code that was called from the C MEX S-function wrapper).

---

**Note** A MEX S-function wrapper must only be used in the MATLAB version in which the wrapper is created.

---

Suppose you have an algorithm (that is, a C function) called `my_alg` that resides in the file `my_alg.c`. You can integrate `my_alg` into a Simulink model by creating a MEX S-function wrapper (for example, `wrapsfcn.c`). Once this is done, a Simulink model can call `my_alg` from an S-Function block. However, the Simulink S-function contains a set of empty functions that the Simulink engine requires for various API-related purposes. For example, although only `mdlOutputs` calls `my_alg`, the engine calls `mdlTerminate` as well, even though this S-function routine performs no action.

You can integrate `my_alg` into generated code (that is, embed the call to `my_alg` in the generated code) by creating a TLC S-function wrapper (for example, `wrapsfcn.tlc`). The advantage of creating a TLC S-function wrapper is that the empty function calls can be eliminated and the overhead of executing the `mdlOutputs` function and then the `my_alg` function can be eliminated.

Wrapper S-functions are useful when you are creating new algorithms that are procedural in nature or when you are integrating legacy code into a Simulink model. However, if you want to create code that is

- Interpretive in nature (that is, highly parameterized by operating modes)
- Heavily optimized (that is, no extra tests to decide what mode the code is operating in)

then you must create a *fully inlined TLC file* for your S-function.

The next figure shows the wrapper S-function concept.

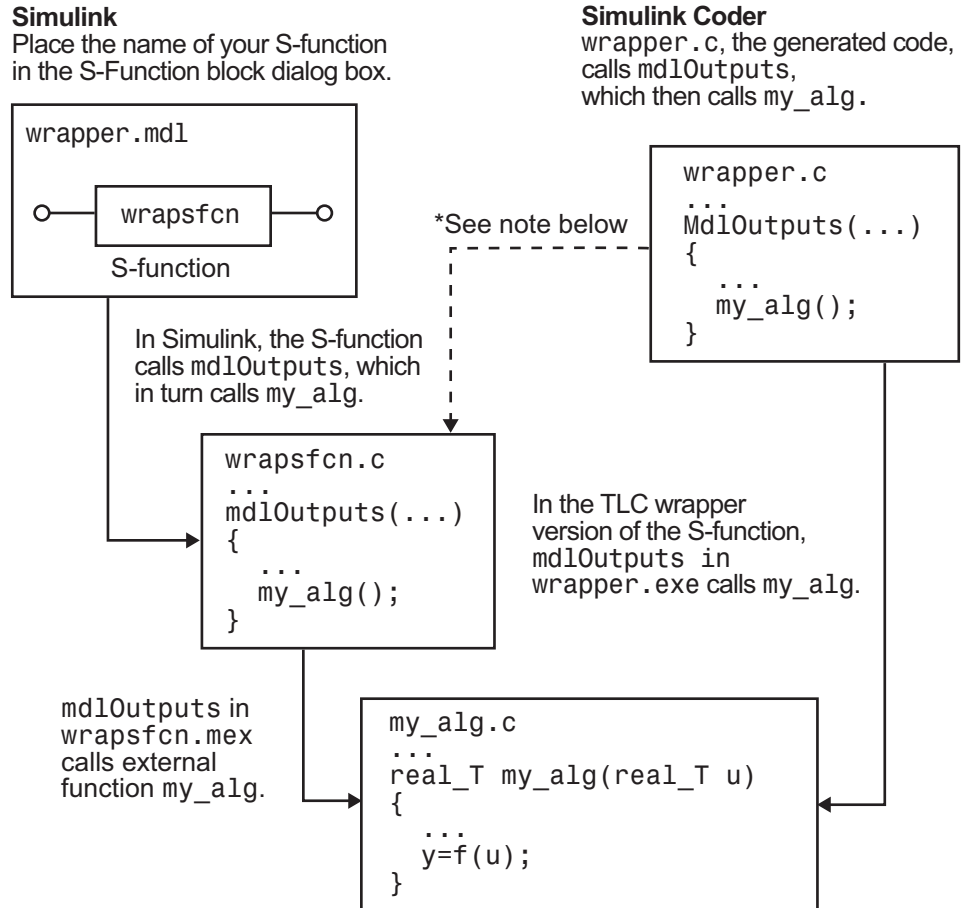

\*The dotted line is the path taken if the S-function does not have a TLC wrapper file. If there is no TLC wrapper file, the generated code calls mdlOutputs.

Using an S-function wrapper to import algorithms in your Simulink model means that the S-function serves as an interface that calls your C/C++ algorithms from mdlOutputs. S-function wrappers have the advantage that you can quickly integrate large standalone C/C++ programs into your model without having to make changes to the code.



The following sample model includes an S-function wrapper.

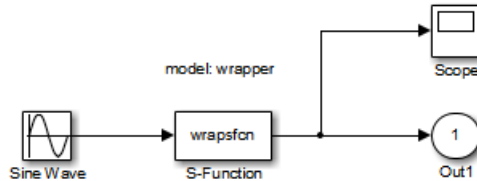

There are two files associated with the `wrapsfcn` block, the S-function wrapper and the C/C++ code that contains the algorithm. The S-function wrapper code for `wrapsfcn.c` appears below. The first three statements do the following:

- 1** Defines the name of the S-function (what you enter in the Simulink S-Function block dialog).
- 2** Specifies that the S-function is using the level 2 format.
- 3** Provides access to the `SimStruct` data structure, which contains pointers to data used during simulation and code generation and defines macros that store data in and retrieve data from the `SimStruct`.

For more information, see “Templates for C S-Functions” in the Simulink documentation.

```

#define S_FUNCTION_NAME wrapsfcn
#define S_FUNCTION_LEVEL 2
#include "simstruc.h"

extern real_T my_alg(real_T u); /* Declare my_alg as extern */

/*
 * mdlInitializeSizes - initialize the sizes array
 */
static void mdlInitializeSizes(SimStruct *S)
{

    ssSetNumSFcnParams( S, 0); /*number of input arguments*/

    if (!ssSetNumInputPorts(S, 1)) return;
  
```

```
    ssSetInputPortWidth(S, 0, 1);
    ssSetInputPortDirectFeedThrough(S, 0, 1);

    if (!ssSetNumOutputPorts(S,1)) return;
    ssSetOutputPortWidth(S, 0, 1);

    ssSetNumSampleTimes( S, 1);
}

/*
 * mdlInitializeSampleTimes - indicate that this S-function runs
 * at the rate of the source (driving block)
 */
static void mdlInitializeSampleTimes(SimStruct *S)
{
    ssSetSampleTime(S, 0, INHERITED_SAMPLE_TIME);
    ssSetOffsetTime(S, 0, 0.0);
}

/*
 * mdlOutputs - compute the outputs by calling my_alg, which
 * resides in another module, my_alg.c
 */
static void mdlOutputs(SimStruct *S, int_T tid)
{
    InputRealPtrsType uPtrs = ssGetInputPortRealSignalPtrs(S,0);
    real_T          *y      = ssGetOutputPortRealSignal(S,0);
    *y = my_alg(*uPtrs[0]); /* Call my_alg in mdlOutputs */
}

/*
 * mdlTerminate - called when the simulation is terminated.
 */
static void mdlTerminate(SimStruct *S)
{
}

#ifdef MATLAB_MEX_FILE /* Is this file being compiled as a MEX-file? */
#include "simulink.c" /* MEX-file interface mechanism */
#else
```

```
#include "cg_sfun.h" /* Code generation registration function */
#endif
```

The S-function routine `mdlOutputs` contains a function call to `my_alg`, which is the C function containing the algorithm that the S-function performs. This is the code for `my_alg.c`:

```
#ifdef MATLAB_MEX_FILE
#include "tmwtypes.h"
#else
#include "rtwtypes.h"
#endif
real_T my_alg(real_T u)
{
return(u * 2.0);
}
```

See the section “Header Dependencies When Interfacing Legacy/Custom Code with Generated Code” on page 10-6 in the Simulink Coder documentation for more information.

The wrapper S-function `wrapsfcn` calls `my_alg`, which computes  $u * 2.0$ . To build `wrapsfcn.mex`, use the following command:

```
mex wrapsfcn.c my_alg.c
```

## TLC S-Function Wrapper

This section describes how to inline the call to `my_alg` in the `mdlOutputs` section of the generated code. In the above example, the call to `my_alg` is embedded in the `mdlOutputs` section as

```
*y = my_alg(*uPtrs[0]);
```

When you are creating a TLC S-function wrapper, the goal is to embed the same type of call in the generated code.

It is instructive to look at how the code generator executes S-functions that are not inlined. A noninlined S-function is identified by the absence of the file `sfunction.tlc` and the existence of `sfunction.mex`. When generating

code for a noninlined S-function, the Simulink Coder software generates a call to `mdlOutputs` through a function pointer that, in this example, then calls `my_alg`.

The wrapper example contains one S-function, `wrapsfcn.mex`. You must compile and link an additional module, `my_alg`, with the generated code. To do this, specify

```
set_param('wrapper/S-Function', 'SFunctionModules', 'my_alg')
```

**Code Overhead for Noninlined S-Functions.** The code generated when using `grt.tlc` as the system target file *without* `wrapsfcn.tlc` is

<Generated code comments for wrapper model with **noninlined** `wrapsfcn` S-function>

```
#include <math.h>
#include <string.h>
#include "wrapper.h"
#include "wrapper.prm"

/* Start the model */
void mdlStart(void)
{
    /* (no start code required) */
}

/* Compute block outputs */
void mdlOutputs(int_T tid)
{
    /* Sin Block: <Root>/Sin */
    rtB.Sin = rtP.Sin.Amplitude *
        sin(rtP.Sin.Frequency * ssGetT(rts) + rtP.Sin.Phase);

    /* Level2 S-Function Block: <Root>/S-Function (wrapsfcn) */
    {
        /* Noninlined S-functions create a SimStruct object and
         * generate a call to S-function routine mdlOutputs
         */
        SimStruct *rts = ssGetSFunction(rts, 0);
        sfcnOutputs(rts, tid);
    }
}
```

```

    /* Outport Block: <Root>/Out */
    rtY.Out = rtB.S_Function;
}

/* Perform model update */
void mdlUpdate(int_T tid)
{
    /* (no update code required) */
}

/* Terminate function */
void mdlTerminate(void)
{
    /* Level2 S-Function Block: <Root>/S-Function (wrapsfcn) */
    {
        /* Noninlined S-functions require a SimStruct object and
         * the call to S-function routine mdlTerminate
         */
        SimStruct *rts = ssGetSFunction(rtS, 0);
        sfcnTerminate(rts);
    }
}

#include "wrapper.reg"

/* [EOF] wrapper.c */

```

In addition to the overhead outlined above, the `wrapper.reg` generated file contains the initialization of the `SimStruct` for the wrapper S-Function block. There is one child `SimStruct` for each S-Function block in your model. You can significantly reduce this overhead by creating a TLC wrapper for the S-function.

**How to Inline.** The generated code makes the call to your S-function, `wrapsfcn.c`, in `mdlOutputs` by using this code:

```

SimStruct *rts = ssGetSFunction(rtS, 0);
sfcnOutputs(rts, tid);

```

This call has computational overhead associated with it. First, the Simulink engine creates a `SimStruct` data structure for the S-Function block. Second, the code generator constructs a call through a function pointer to execute `mdlOutputs`, then `mdlOutputs` calls `my_alg`. By inlining the call to your C/C++ algorithm, `my_alg`, you can eliminate both the `SimStruct` and the extra function call, thereby improving the efficiency and reducing the size of the generated code.

Inlining a wrapper S-function requires an `sfunction.tlc` file for the S-function (see the “Target Language Compiler” for details). The TLC file must contain the function call to `my_alg`. The following figure shows the relationships between the algorithm, the wrapper S-function, and the `sfunction.tlc` file.

The `wrapsfcn.tlc` file tells Simulink Coder how to inline the call to `my_alg` using this statement.

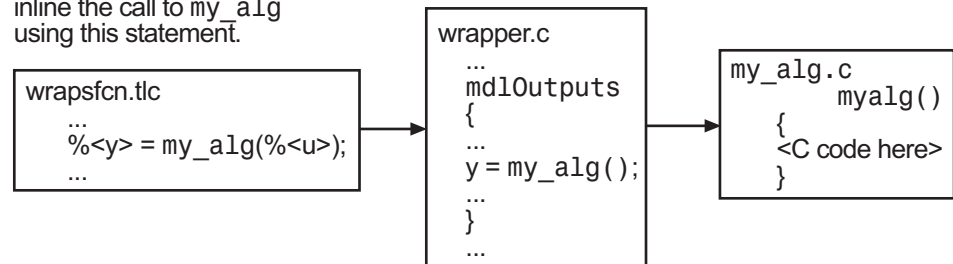

To inline this call, you have to place your function call in an `sfunction.tlc` file with the same name as the S-function (in this example, `wrapsfcn.tlc`). This causes the Target Language Compiler to override the default method of placing calls to your S-function in the generated code.

This is the `wrapsfcn.tlc` file that inlines `wrapsfcn.c`.

```

%% File      : wrapsfcn.tlc
%% Abstract:
%%      Example inlined tlc file for S-function wrapsfcn.c
%%
%%
%implements "wrapsfcn" "C"

```

```

%% Function: BlockTypeSetup =====
%% Abstract:
%%     Create function prototype in model.h as:
%%     "extern real_T my_alg(real_T u);"
%%
%function BlockTypeSetup(block, system) void
    %openfile buffer
        extern real_T my_alg(real_T u); /* This line is placed in wrapper.h */
    %closefile buffer
    %<LibCacheFunctionPrototype(buffer)>
%endfunction %% BlockTypeSetup

%% Function: Outputs =====
%% Abstract:
%%     y = my_alg( u );
%%
%function Outputs(block, system) Output
    /* %<Type> Block: %<Name> */
    %assign u = LibBlockInputSignal(0, "", "", 0)
    %assign y = LibBlockOutputSignal(0, "", "", 0)
    %% PROVIDE THE CALLING STATEMENT FOR "algorithm"
    %% The following line is expanded and placed in mdlOutputs within wrapper.c
    %<y> = my_alg(%<u>);

%endfunction %% Outputs

```

The first section of this code inlines the wrapsfcn S-Function block and generates the code in C:

```
%implements "wrapsfcn" "C"
```

The next task is to tell the code generator that the routine `my_alg` needs to be declared external in the generated `wrapper.h` file for any `wrapsfcn` S-Function blocks in the model. You only need to do this once for all `wrapsfcn` S-Function blocks, so use the `BlockTypeSetup` function. In this function, you tell the Target Language Compiler to create a buffer and cache the `my_alg` as `extern` in the `wrapper.h` generated header file.

The final step is the inlining of the call to the function `my_alg`. This is done by the `Outputs` function. In this function, you access the block's input and output and place a direct call to `my_alg`. The call is embedded in `wrapper.c`.

### The Inlined Code

The code generated when you inline your wrapper S-function is similar to the default generated code. The `mdlTerminate` function no longer contains a call to an empty function and the `mdlOutputs` function now directly calls `my_alg`.

```
void mdlOutputs(int_T tid)
{
    /* Sin Block: <Root>/Sin */
    rtB.Sin = rtP.Sin.Amplitude *
        sin(rtP.Sin.Frequency * ssGetT(rtS) + rtP.Sin.Phase);

    /* S-Function Block: <Root>/S-Function */
    rtB.S_Function = my_alg(rtB.Sin); /* Inlined call to my_alg */

    /* Outputport Block: <Root>/Out */
    rtY.Out = rtB.S_Function;
}
```

In addition, `wrapper.reg` no longer creates a child `SimStruct` for the S-function because the generated code is calling `my_alg` directly. This eliminates over 1 KB of memory usage.

### Write Fully Inlined S-Functions

Continuing the example of the previous section, you could eliminate the call to `my_alg` entirely by specifying the explicit code (that is, `2.0 * u`) in `wrapsfcn.tlc`. This is referred to as a *fully inlined S-function*. While this can improve performance, if you are working with a large amount of C/C++ code, this can be a lengthy task. In addition, you now have to maintain your algorithm in two places, the C/C++ S-function itself and the corresponding TLC file. However, the performance gains might outweigh the disadvantages. To inline the algorithm used in this example, in the `Outputs` section of your `wrapsfcn.tlc` file, instead of writing

```
%<y> = my_alg(%<u>);
```



```

use

%<y> = 2.0 * %<u>;

```

This is the code produced in mdlOutputs:

```

void mdlOutputs(int_T tid)
{
    /* Sin Block: <Root>/Sin */
    rtB.Sin = rtP.Sin.Amplitude *
        sin(rtP.Sin.Frequency * ssGetT(rtS) + rtP.Sin.Phase);

    /* S-Function Block: <Root>/S-Function */
    rtB.S_Function = 2.0 * rtB.Sin; /* Explicit embedding of algorithm */

    /* Output Block: <Root>/Out */
    rtY.Out = rtB.S_Function;
}

```

The Target Language Compiler has replaced the call to `my_alg` with the algorithm itself.

## Multiport S-Function

A more advanced multiport inlined S-function example is `sfun_multiport.c` and `sfun_multiport.tlc`. This S-function illustrates how to create a fully inlined TLC file for an S-function that contains multiple ports. You might find that looking at this example helps you to understand fully inlined TLC files.

## Write Fully Inlined S-Functions with mdlRTW Routine

- “About S-Functions and mdlRTW” on page 14-66
- “S-Function RTWdata” on page 14-67
- “Direct-Index Lookup Table Algorithm” on page 14-67
- “Direct-Index Lookup Table Example” on page 14-69

## About S-Functions and mdlRTW

You can inline more complex S-functions that use the S-function `mdlRTW` routine. The purpose of the `mdlRTW` routine is to provide the code generation process with more information about how the S-function is to be inlined, by creating a parameter record of a nontunable parameter for use with a TLC file. The `mdlRTW` routine does this by placing information in the `model.rtw` file. The `mdlRTW` function is described in the text file `matlabroot/simulink/src/sfuntmpl_doc.c`.

As an example of how to use the `mdlRTW` function, this section discusses the steps you must take to create a direct-index lookup S-function. Lookup tables are collections of ordered data points of a function. Typically, these tables use some interpolation scheme to approximate values of the associated function between known data points. To incorporate the example lookup table algorithm into a Simulink model, the first step is to write an S-function that executes the algorithm in `mdlOutputs`. To produce the most efficient code, the next step is to create a corresponding TLC file to eliminate computational overhead and improve the performance of the lookup computations.

For your convenience, the Simulink product provides support for two general-purpose lookup 1-D and 2-D algorithms. You can use these algorithms as they are or create a custom lookup table S-function to fit your requirements. This section illustrates how to create a 1-D lookup S-function, `sfun_directlook.c`, and its corresponding inlined `sfun_directlook.tlc` file (see “Target Language Compiler” for more details). This 1-D direct-index lookup table example illustrates the following concepts that you need to know to create your own custom lookup tables:

- Error checking of S-function parameters
- Caching of information for the S-function that doesn't change during model execution
- How to use the `mdlRTW` function to customize Simulink Coder generated code to produce the optimal code for a given set of block parameters
- How to generate an inlined TLC file for an S-function in a combination of the fully inlined form and/or the wrapper form

## S-Function RTWdata

There is a property of blocks called `RTWdata`, which can be used by the Target Language Compiler when inlining an S-function. `RTWdata` is a structure of strings that you can attach to a block. It is saved with the model and placed in the `model.rtw` file when generating code. For example, this set of MATLAB commands,

```
mydata.field1 = 'information for field1';
mydata.field2 = 'information for field2';
set_param(gcf, 'RTWdata', mydata)
get_param(gcf, 'RTWdata')
```

produces this result:

```
ans =

    field1: 'information for field1'
    field2: 'information for field2'
```

Inside the `model.rtw` file for the associated S-Function block is this information.

```
Block {
  Type                "S-Function"
  RTWdata {
    field1             "information for field1"
    field2             "information for field2"
  }
}
```

---

**Note** `RTWdata` is saved in the model file for S-functions that are not linked to a library. However, `RTWdata` is **not persistent** for S-Function blocks that are linked to a library.

---

## Direct-Index Lookup Table Algorithm

The 1-D lookup table block provided in the Simulink library uses interpolation or extrapolation when computing outputs. This extra accuracy might not be required. In this example, you create a lookup table that directly indexes the output vector ( $y$ -data vector) based on the current input ( $x$ -data) point.

This direct 1-D lookup example computes an approximate solution  $p(x)$  to a partially known function  $f(x)$  at  $x=x_0$ , given data point pairs  $(x,y)$  in the form of an  $x$ -data vector and a  $y$ -data vector. For a given data pair (for example, the  $i$ 'th pair),  $y_i = f(x_i)$ . It is assumed that the  $x$ -data values are monotonically increasing. If  $x_0$  is outside the range of the  $x$ -data vector, the first or last point is returned.

The parameters to the S-function are

XData, YData, XEvenlySpaced

XData and YData are double vectors of equal length representing the values of the unknown function. XDataEvenlySpaced is a scalar, 0.0 for false and 1.0 for true. If the XData vector is evenly spaced, XDataEvenlySpaced is 1.0 and more efficient code is generated.

The following graph shows how the parameters XData=[1:6] and YData=[1,2,7,4,5,9] are handled. For example, if the input ( $x$ -value) to the S-Function block is 3, the output ( $y$ -value) is 7.

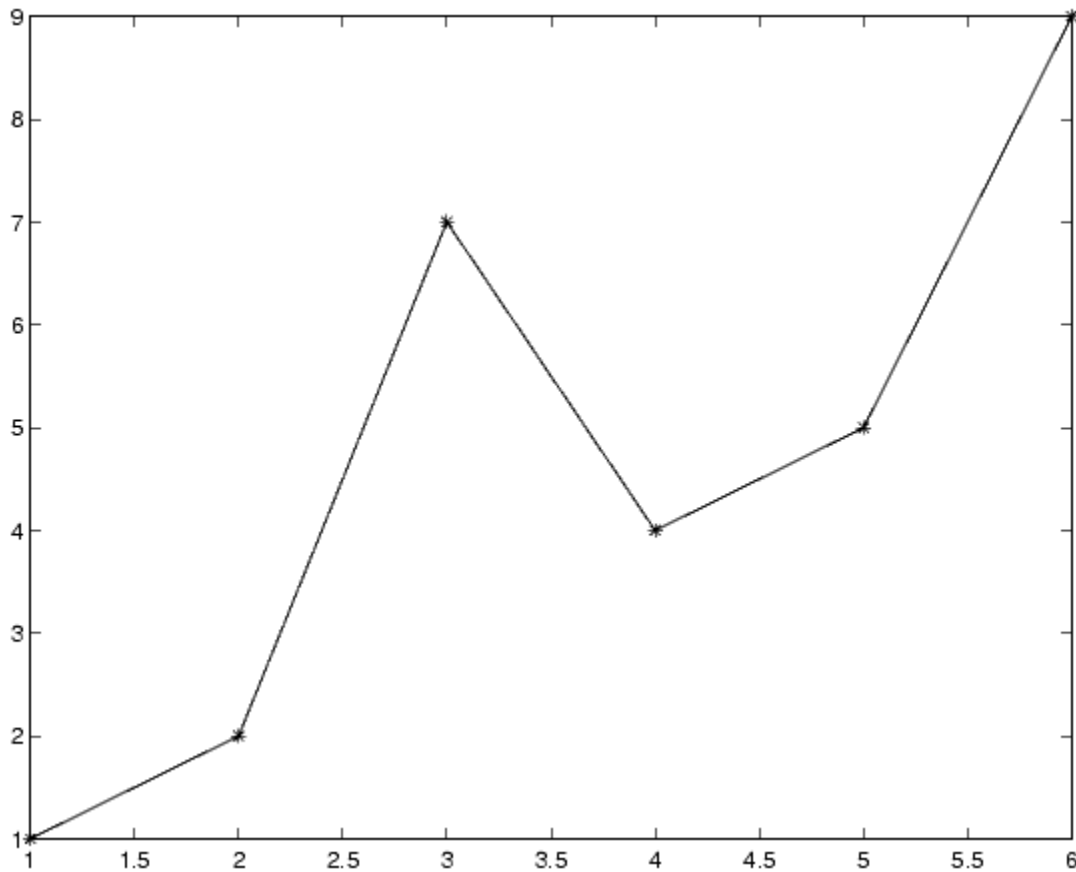

### Direct-Index Lookup Table Example

This section shows how to improve the lookup table by inlining a direct-index S-function with a TLC file. This direct-index lookup table S-function does not require a TLC file. Here the example uses a TLC file for the direct-index lookup table S-function to reduce the code size and increase efficiency of the generated code.

Implementation of the direct-index algorithm with inlined TLC file requires the S-function main module, `sfun_directlook.c`, and a corresponding

lookup\_index.c module. The lookup\_index.c module contains the GetDirectLookupIndex function that is used to locate the index in the XData for the current x input value when the XData is unevenly spaced. The GetDirectLookupIndex routine is called from both the S-function and the generated code. Here the example uses the wrapper concept for sharing C/C++ code between Simulink MEX-files and the generated code.

If the XData is evenly spaced, then both the S-function main module and the generated code contain the lookup algorithm (not a call to the algorithm) to compute the y-value of a given x-value, because the algorithm is short. This illustrates the use of a fully inlined S-function for generating optimal code.

The inlined TLC file, which either performs a wrapper call or embeds the optimal C/C++ code, is sfun\_directlook.tlc (see the example in “mdlRTW Usage” on page 14-71).

**Error Handling.** In this example, the mdlCheckParameters routine verifies that

- The new parameter settings valid..
- XData and YData are vectors of the same length containing real finite numbers.
- XDataEvenlySpaced is a scalar.
- The XData vector is a monotonically increasing vector and evenly spaced.

The mdlInitializeSizes function explicitly calls mdlCheckParameters after it verifies the number of parameters passed to the S-function. After the Simulink engine calls mdlInitializeSizes, it then calls mdlCheckParameters whenever you change the parameters or there is a need to reevaluate them.

**User Data Caching.** The mdlStart routine shows how to cache information that does not change during the simulation (or while the generated code is executing). The example caches the value of the XDataEvenlySpaced parameter in UserData, a field of the SimStruct. The following line in mdlInitializeSizes tells the Simulink engine to disallow changes to XDataEvenlySpaced.

```
ssSetSFcnParamTunable(S, iParam, SS_PRM_NOT_TUNABLE);
```

During execution, `mdlOutputs` accesses the value of `XDataEvenlySpaced` from `UserData` rather than calling the `mxGetPr` MATLAB API function. This increases performance.

**mdlRTW Usage.** The Simulink Coder code generator calls the `mdlRTW` routine while generating the `model.rtw` file. To produce optimal code for your Simulink model, you can add information to the `model.rtw` file about the mode in which your S-Function block is operating.

The following example adds parameter settings to the `model.rtw` file. The parameter settings do not change during execution. In this case, the `XDataEvenlySpaced` S-function parameter cannot change during execution (`ssSetSFcnParamTunable` was specified as `false` (0) for it in `mdlInitializeSizes`). The example writes it out as a parameter setting (`XSpacing`) using the function `ssWriteRTWParamSettings`.

Because `xData` and `yData` are registered as run-time parameters in `mdlSetWorkWidths`, the code generator handles writing to the `model.rtw` file automatically.

Before examining the S-function and the inlined TLC file, consider the generated code for the following model.

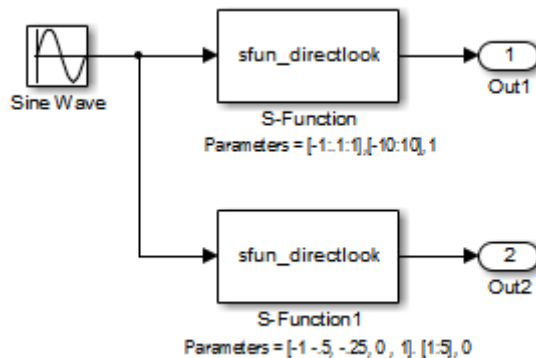

The model uses evenly spaced XData in the top S-Function block and unevenly spaced XData in the bottom S-Function block. When creating this model, you need to specify the following for each S-Function block.

```
set_param('sfun_directlook_ex/S-Function', 'SFunctionModules', 'lookup_index')
set_param('sfun_directlook_ex/S-Function1', 'SFunctionModules', 'lookup_index')
```

This informs the Simulink Coder build process to use the module `lookup_index.c` when creating the executable.

When generating code for this model, the Simulink Coder software uses the S-function's `mdlRTW` method to generate a `model.rtw` file with the value `EvenlySpaced` for the `XSpacing` parameter for the top S-Function block, and the value `UnEvenlySpaced` for the `XSpacing` parameter for the bottom S-Function block. The TLC-file uses the value of `XSpacing` to determine what algorithm to include in the generated code. The generated code contains the lookup algorithm when the XData is evenly spaced, but calls the `GetDirectLookupIndex` routine when the XData is unevenly spaced. The generated `model.c` or `model.cpp` code for the lookup table example model is similar to the following:

```
/*
 * sfun_directlook_ex.c
 *
 * Code generation for Simulink model
 * "sfun_directlook_ex.slx".
 *
...
*/

#include "sfun_directlook_ex.h"
#include "sfun_directlook_ex_private.h"

/* External output (root outputs fed by signals with auto storage) */
ExternalOutputs_sfundirectlook_ex sfundirectlook_ex_Y;

/* Real-time model */
rtModel_sfundirectlook_ex sfundirectlook_ex_M;
rtModel_sfundirectlook_ex *sfundirectlook_ex_M = &sfundirectlook_ex_M;
```



```

/* Model output function */
static void sfun_directlook_ex_output(int_T tid)
{

    /* local block i/o variables */

    real_T rtb_SFunction_h;
    real_T rtb_temp1;

    /* Sin: '<Root>/Sine Wave' */
    rtb_temp1 = sfun_directlook_ex_P.SineWave_Amp *
        sin(sfun_directlook_ex_P.SineWave_Freq * sfun_directlook_ex_M->Timing.t[0] +
            sfun_directlook_ex_P.SineWave_Phase) + sfun_directlook_ex_P.SineWave_Bias;

    /* Code that is inlined for the top S-function block in the
     * sfun_directlook_ex model
     */
    /* S-Function Block: <Root>/S-Function */
    {
        const real_T *xData = &sfun_directlook_ex_P.SFunction_XData[0];
        const real_T *yData = &sfun_directlook_ex_P.SFunction_YData[0];
        real_T spacing = xData[1] - xData[0];

        if ( rtb_temp1 <= xData[0] ) {
            rtb_SFunction_h = yData[0];
        } else if ( rtb_temp1 >= yData[20] ) {
            rtb_SFunction_h = yData[20];
        } else {
            int_T idx = (int_T)( ( rtb_temp1 - xData[0] ) / spacing );
            rtb_SFunction_h = yData[idx];
        }
    }

    /* Output: '<Root>/Out1' */
    sfun_directlook_ex_Y.Out1 = rtb_SFunction_h;

    /* Code that is inlined for the bottom S-function block in the
     * sfun_directlook_ex model
     */
    /* S-Function Block: <Root>/S-Function1 */

```

```
{
    const real_T *xDData = &sfun_directlook_ex_P.SFunction1_XData[0];
    const real_T *yData = &sfun_directlook_ex_P.SFunction1_YData[0];
    int_T idx;

    idx = GetDirectLookupIndex(xData, 5, rtb_temp1);
    rtb_temp1 = yData[idx];
}

/* Output: '<Root>/Out2' */
sfun_directlook_ex_Y.Out2 = rtb_temp1;
}

/* Model update function */
static void sfun_directlook_ex_update(int_T tid)
{
    /* Update absolute time for base rate */

    if(++sfun_directlook_ex_M->Timing.clockTick0)
    ++sfun_directlook_ex_M->Timing.clockTickH0;
    sfun_directlook_ex_M->Timing.t[0] = sfun_directlook_ex_M->Timing.clockTick0 *
        sfun_directlook_ex_M->Timing.stepSize0 +
        sfun_directlook_ex_M->Timing.clockTickH0 *
        sfun_directlook_ex_M->Timing.stepSize0 * 0x10000;

    {
        /* Update absolute timer for sample time: [0.1s, 0.0s] */

        if(++sfun_directlook_ex_M->Timing.clockTick1)
        ++sfun_directlook_ex_M->Timing.clockTickH1;
        sfun_directlook_ex_M->Timing.t[1] = sfun_directlook_ex_M->Timing.clockTick1
            * sfun_directlook_ex_M->Timing.stepSize1 +
            sfun_directlook_ex_M->Timing.clockTickH1 *
            sfun_directlook_ex_M->Timing.stepSize1 * 0x10000;
    }
}
...

```

***matlabroot/toolbox/simulink/simdemos/simfeatures/src/sfun\_directlook.c.***

```

/*
* File   : sfun_directlook.c
* Abstract:
*
*   Direct 1-D lookup. Here we are trying to compute an approximate
*   solution, p(x) to an unknown function f(x) at x=x0, given data point
*   pairs (x,y) in the form of a x data vector and a y data vector. For a
*   given data pair (say the i'th pair), we have y_i = f(x_i). It is
*   assumed that the x data values are monotonically increasing. If the
*   x0 is outside of the range of the x data vector, then the first or
*   last point will be returned.
*
*   This function returns the "nearest" y0 point for a given x0. No
*   interpolation is performed.
*
*   The S-function parameters are:
*       XData           - double vector
*       YData           - double vector
*       XDataEvenlySpacing - double scalar 0 (false) or 1 (true)
*       The third parameter cannot be changed during simulation.
*
*   To build:
*       mex sfun_directlook.c lookup_index.c
*
*   Copyright 1990-2004 The MathWorks, Inc.
*   $Revision: 1.1.8.11.2.4 $
*/

#define S_FUNCTION_NAME sfun_directlook
#define S_FUNCTION_LEVEL 2

#include <math.h>
#include "simstruc.h"
#include <float.h>

/* use utility function IsRealVect() */
#if defined(MATLAB_MEX_FILE)

```

```
#include "sfun_slutils.h"
#endif

/*=====
 * Build checking *
 *=====*/
#if !defined(MATLAB_MEX_FILE)
/*
 * This file cannot be used directly with Simulink Coder. However,
 * this S-function does work with Simulink Coder via
 * the Target Language Compiler technology. See matlabroot/
 * toolbox/simulink/simdemos/simfeatures/tlc_c/sfun_directlook.tlc
 * for the C version
 */
# error This_file_can_be_used_only_during_simulation_inside_Simulink
#endif

/*=====
 * Defines *
 *=====*/

#define XVECT_PIDX          0
#define YVECT_PIDX          1
#define XDATAEVENLYSPACED_PIDX 2
#define NUM_PARAMS          3

#define XVECT(S)            ssGetSFcnParam(S,XVECT_PIDX)
#define YVECT(S)            ssGetSFcnParam(S,YVECT_PIDX)
#define XDATAEVENLYSPACED(S) ssGetSFcnParam(S,XDATAEVENLYSPACED_PIDX)

/*=====
 * misc defines *
 *=====*/
#if !defined(TRUE)
#define TRUE 1
#endif
#if !defined(FALSE)
#define FALSE 0
#endif
```

```

#endif

/*=====
 * typedef's *
 *=====*/

typedef struct SFcnCache_tag {
    boolean_T evenlySpaced;
} SFcnCache;

/*=====
 * Prototype define for the function in separate file lookup_index.c *
 *=====*/
extern int_T GetDirectLookupIndex(const real_T *x, int_T xlen, real_T u);

/*=====
 * S-function methods *
 *=====*/

#define MDL_CHECK_PARAMETERS          /* Change to #undef to remove function */
#if defined(MDL_CHECK_PARAMETERS) && defined(MATLAB_MEX_FILE)
/* Function: mdlCheckParameters =====
 * Abstract:
 *   This routine will be called after mdlInitializeSizes, whenever
 *   parameters change or get re-evaluated. The purpose of this routine is
 *   to verify the new parameter settings.
 *
 *   You should add a call to this routine from mdlInitalizeSizes
 *   to check the parameters. After setting your sizes elements, you should:
 *       if (ssGetSFcnParamsCount(S) == ssGetNumSFcnParams(S)) {
 *           mdlCheckParameters(S);
 *       }
 */
static void mdlCheckParameters(SimStruct *S)
{

    if (!IsRealVect(XVECT(S))) {
        ssSetErrorStatus(S,"1st, X-vector parameter must be a real finite "

```

```
        " vector");
    return;
}

if (!IsRealVect(YVECT(S))) {
    ssSetErrorStatus(S,"2nd, Y-vector parameter must be a real finite "
        "vector");
    return;
}

/*
 * Verify that the dimensions of X and Y are the same.
 */
if (mxGetNumberOfElements(XVECT(S)) != mxGetNumberOfElements(YVECT(S)) ||
    mxGetNumberOfElements(XVECT(S)) == 1) {
    ssSetErrorStatus(S,"X and Y-vectors must be of the same dimension "
        "and have at least two elements");
    return;
}

/*
 * Verify we have a valid XDataEvenlySpaced parameter.
 */
if ((!mxIsNumeric(XDATAEVENLYSPACED(S)) &&
    !mxIsLogical(XDATAEVENLYSPACED(S))) ||
    mxIsComplex(XDATAEVENLYSPACED(S)) ||
    mxGetNumberOfElements(XDATAEVENLYSPACED(S)) != 1) {
    ssSetErrorStatus(S,"3rd, X-evenly-spaced parameter must be logical
scalar");
    return;
}

/*
 * Verify x-data is correctly spaced.
 */
{
    int_T      i;
    boolean_T  spacingEqual;
    real_T     *xData = mxGetPr(XVECT(S));
    int_T      numEl   = mxGetNumberOfElements(XVECT(S));
```

```

/*
 * spacingEqual is TRUE if user XDataEvenlySpaced
 */
spacingEqual = (mxGetScalar(XDATAEVENLYSPACED(S)) != 0.0);

if (spacingEqual) { /* XData is 'evenly-spaced' */
    boolean_T badSpacing = FALSE;
    real_T spacing = xData[1] - xData[0];
    real_T space;

    if (spacing <= 0.0) {
        badSpacing = TRUE;
    } else {
        real_T eps = DBL_EPSILON;

        for (i = 2; i < numEl; i++) {
            space = xData[i] - xData[i-1];
            if (space <= 0.0 ||
                fabs(space-spacing) >= 128.0*eps*spacing ){
                badSpacing = TRUE;
                break;
            }
        }
    }

    if (badSpacing) {
        ssSetErrorStatus(S,"X-vector must be an evenly spaced "
            "strictly monotonically increasing vector");
        return;
    }
} else { /* XData is 'unevenly-spaced' */
    for (i = 1; i < numEl; i++) {
        if (xData[i] <= xData[i-1]) {
            ssSetErrorStatus(S,"X-vector must be a strictly "
                "monotonically increasing vector");
            return;
        }
    }
}
}

```

```
    }
}
#endif /* MDL_CHECK_PARAMETERS */

/* Function: mdlInitializeSizes =====
 * Abstract:
 *   The sizes information is used by Simulink to determine the S-function
 *   block's characteristics (number of inputs, outputs, states, and so on).
 */
static void mdlInitializeSizes(SimStruct *S)
{
    ssSetNumSFcnParams(S, NUM_PARAMS); /* Number of expected parameters */

    /*
     * Check parameters passed in, providing the correct number was specified
     * in the S-function dialog box. If an incorrect number of parameters
     * was specified, Simulink will detect the error since ssGetNumSFcnParams
     * and ssGetSFcnParamsCount will differ.
     * ssGetNumSFcnParams - This sets the number of parameters your
     *                       S-function expects.
     * ssGetSFcnParamsCount - This is the number of parameters entered by
     *                       the user in the Simulink S-function dialog box.
     */
    #if defined(MATLAB_MEX_FILE)
        if (ssGetNumSFcnParams(S) == ssGetSFcnParamsCount(S)) {
            mdlCheckParameters(S);
            if (ssGetErrorStatus(S) != NULL) {
                return;
            }
        } else {
            return; /* Parameter mismatch will be reported by Simulink */
        }
    #endif

    {
        int iParam = 0;
        int nParam = ssGetNumSFcnParams(S);
```



```
for ( iParam = 0; iParam < nParam; iParam++ )
{
    switch ( iParam )
    {
        case XDATAEVENLYSPACED_PIDX:

            ssSetSFcnParamTunable( S, iParam, SS_PRM_NOT_TUNABLE );
            break;

        default:
            ssSetSFcnParamTunable( S, iParam, SS_PRM_TUNABLE );
            break;
    }
}

ssSetNumContStates(S, 0);
ssSetNumDiscStates(S, 0);

if (!ssSetNumInputPorts(S, 1)) return;
ssSetInputPortWidth(S, 0, DYNAMICALLY_SIZED);
ssSetInputPortDirectFeedThrough(S, 0, 1);

ssSetInputPortOptimOpts(S, 0, SS_REUSABLE_AND_LOCAL);
ssSetInputPortOverWritable(S, 0, TRUE);

if (!ssSetNumOutputPorts(S, 1)) return;
ssSetOutputPortWidth(S, 0, DYNAMICALLY_SIZED);

ssSetOutputPortOptimOpts(S, 0, SS_REUSABLE_AND_LOCAL);

ssSetNumSampleTimes(S, 1);

ssSetOptions(S,
             SS_OPTION_WORKS_WITH_CODE_REUSE |
             SS_OPTION_EXCEPTION_FREE_CODE |
             SS_OPTION_USE_TLC_WITH_ACCELERATOR);
} /* mdlInitializeSizes */
```

```
/* Function: mdlInitializeSampleTimes =====
 * Abstract:
 *   The lookup inherits its sample time from the driving block.
 */
static void mdlInitializeSampleTimes(SimStruct *S)
{
    ssSetSampleTime(S, 0, INHERITED_SAMPLE_TIME);
    ssSetOffsetTime(S, 0, 0.0);
    ssSetModelReferenceSampleTimeDefaultInheritance(S);
} /* end mdlInitializeSampleTimes */

/* Function: mdlSetWorkWidths =====
 * Abstract:
 *   Set up the [X,Y] data as run-time parameters
 *   that is, these values can be changed during execution.
 */
#define MDL_SET_WORK_WIDTHS
static void mdlSetWorkWidths(SimStruct *S)
{
    const char_T    *rtParamNames[] = {"XData","YData"};
    ssRegAllTunableParamsAsRunTimeParams(S, rtParamNames);
}

#define MDL_START                /* Change to #undef to remove function */
#if defined(MDL_START)
/* Function: mdlStart =====
 * Abstract:
 *   Here we cache the state (true/false) of the XDATAEVENLYSPACED parameter.
 *   We do this primarily to illustrate how to "cache" parameter values (or
 *   information which is computed from parameter values) which do not change
 *   for the duration of the simulation (or in the generated code). In this
 *   case, rather than repeated calls to mxGetPr, we save the state once.
 *   This results in a slight increase in performance.
 */
static void mdlStart(SimStruct *S)
{
    SFcnCache *cache = malloc(sizeof(SFcnCache));
```

```

    if (cache == NULL) {
        ssSetErrorStatus(S,"memory allocation error");
        return;
    }

    ssSetUserData(S, cache);

    if (mxGetScalar(XDATAEVENLYSPACED(S)) != 0.0){
        cache->evenlySpaced = TRUE;
    }else{
        cache->evenlySpaced = FALSE;
    }

}
#endif /* MDL_START */

/* Function: mdlOutputs =====
 * Abstract:
 *   In this function, you compute the outputs of your S-function
 *   block. Generally outputs are placed in the output vector, ssGetY(S).
 */
static void mdlOutputs(SimStruct *S, int_T tid)
{
    SFcnCache      *cache = ssGetUserData(S);
    real_T         *xData = mxGetPr(XVECT(S));
    real_T         *yData = mxGetPr(YVECT(S));
    InputRealPtrsType uPtrs = ssGetInputPortRealSignalPtrs(S,0);
    real_T         *y      = ssGetOutputPortRealSignal(S,0);
    int_T          ny      = ssGetOutputPortWidth(S,0);
    int_T          xLen    = mxGetNumberOfElements(XVECT(S));
    int_T          i;

    /*
     * When the XData is evenly spaced, we use the direct lookup algorithm
     * to calculate the lookup
     */
    if (cache->evenlySpaced) {
        real_T spacing = xData[1] - xData[0];

```

```

        for (i = 0; i < ny; i++) {
            real_T u = *uPtrs[i];

            if (u <= xData[0]) {
                y[i] = yData[0];
            } else if (u >= xData[xLen-1]) {
                y[i] = yData[xLen-1];
            } else {
                int_T idx = (int_T)((u - xData[0])/spacing);
                y[i] = yData[idx];
            }
        }
    } else {
        /*
         * When the XData is unevenly spaced, we use a bisection search to
         * locate the lookup index.
         */
        for (i = 0; i < ny; i++) {
            int_T idx = GetDirectLookupIndex(xData,xLen,*uPtrs[i]);
            y[i] = yData[idx];
        }
    }
} /* end mdlOutputs */

/* Function: mdlTerminate =====
 * Abstract:
 *   Free the cache which was allocated in mdlStart.
 */
static void mdlTerminate(SimStruct *S)
{
    SFcnCache *cache = ssGetUserData(S);
    if (cache != NULL) {
        free(cache);
    }
} /* end mdlTerminate */

```

```

#define MDL_RTW /* Change to #undef to remove function */
#if defined(MDL_RTW) && (defined(MATLAB_MEX_FILE) || defined(NRT))
/* Function: mdlRTW =====
* Abstract:
* This function is called when Simulink Coder is generating the
* model.rtw file. In this routine, you can call the following functions
* which add fields to the model.rtw file.
*
* Important! Since this S-function has this mdlRTW method, it is required
* to have a corresponding .tlc file so as to work with Simulink Coder. See the
* sfun_directlook.tlc in matlabroot/toolbox/simulink/simdemos/simfeatures/tlc_c/.
*/
static void mdlRTW(SimStruct *S)
{
    /*
    * Write out the spacing setting as a param setting, that is, this cannot be
    * changed during execution.
    */
    {
        boolean_T even = (mxGetScalar(XDATAEVENLYSPACED(S)) != 0.0);

        if (!ssWriteRTWParamSettings(S, 1,
                                     SSWRITE_VALUE_QSTR,
                                     "XSpacing",
                                     even ? "EvenlySpaced" : "UnEvenlySpaced")){
            return; /* An error occurred which will be reported by Simulink */
        }
    }
}
#endif /* MDL_RTW */

/*=====
* Required S-function trailer *
*=====*/

#ifdef MATLAB_MEX_FILE /* Is this file being compiled as a MEX-file? */
#include "simulink.c" /* MEX-file interface mechanism */
#else

```

```
#include "cg_sfund.h"      /* Code generation registration function */
#endif

/* [EOF] sfund_directlook.c */

matlabroot/toolbox/simulink/simdemos/simfeatures/src/lookup_index.c

/* File      : lookup_index.c
 * Abstract:
 *
 * Contains a routine used by the S-function sfund_directlookup.c to
 * compute the index in a vector for a given data value.
 *
 * Copyright 1990-2004 The MathWorks, Inc.
 * $Revision: 1.1.8.11.2.4 $
 */
#include "tmwtypes.h"

/*
 * Function: GetDirectLookupIndex =====
 * Abstract:
 * Using a bisection search to locate the lookup index when the x-vector
 * isn't evenly spaced.
 *
 * Inputs:
 * *x   : Pointer to table, x[0] ...x[xlen-1]
 * xlen : Number of values in xtable
 * u    : input value to look up
 *
 * Output:
 * idx  : the index into the table such that:
 * if u is negative
 *     x[idx] <= u < x[idx+1]
 * else
 *     x[idx] < u <= x[idx+1]
 */
int_T GetDirectLookupIndex(const real_T *x, int_T xlen, real_T u)
{
    int_T idx    = 0;
```

```

int_T bottom = 0;
int_T top    = xlen-1;

/*
 * Deal with the extreme cases first:
 *
 * i] u <= x[bottom] then idx = bottom
 * ii] u >= x[top] then idx = top-1
 *
 */
if (u <= x[bottom]) {
    return(bottom);
} else if (u >= x[top]) {
    return(top);
}

/*
 * We have: x[bottom] < u < x[top], onward
 * with search for the index ...
 */
for (;;) {
    idx = (bottom + top)/2;
    if (u < x[idx]) {
        top = idx;
    } else if (u > x[idx+1]) {
        bottom = idx + 1;
    } else {
        /*
         * We have: x[idx] <= u <= x[idx+1], only need
         * to do two more checks and we have the answer
         */
        if (u < 0) {
            /*
             * We want right continuity, that is,
             * if u == x[idx+1]
             * then x[idx+1] <= u < x[idx+2]
             * else x[idx ] <= u < x[idx+1]
             */
            return( (u == x[idx+1]) ? (idx+1) : idx);
        } else {

```

```

        /*
        * We want left continuity, that is,
        * if u == x[idx]
        *   then x[idx-1] < u <= x[idx ]
        * else   x[idx ] < u <= x[idx+1]
        */
        return( (u == x[idx]) ? (idx-1) : idx);
    }
}
} /* end GetDirectLookupIndex */

```

```
/* [EOF] lookup_index.c */
```

### ***matlabroot/toolbox/simulink/simdemos/simfeatures/tlc\_c/sfun\_directlook.tlc.***

```

%% File      : sfun_directlook.tlc
%% Abstract:
%%      Level-2 S-function sfun_directlook block target file.
%%      It is using direct lookup algorithm without interpolation
%%
%% Copyright 1990-2004 The MathWorks, Inc.
%% $Revision: 1.1.8.11.2.4 $

%implements "sfun_directlook" "C"

%% Function: BlockTypeSetup =====
%% Abstract:
%%      Place include and function prototype in the model's header file.
%%
%%function BlockTypeSetup(block, system) void

%% To add this external function's prototype in the header of the generated
%% file.
%%
%%openfile buffer
extern int_T GetDirectLookupIndex(const real_T *x, int_T xlen, real_T u);
%closefile buffer

```



```

    %<LibCacheFunctionPrototype(buffer)>

%endfunction

%% Function: mdlOutputs =====
%% Abstract:
%%     Direct 1-D lookup table S-function example.
%%     Here we are trying to compute an approximate solution,  $p(x)$  to an
%%     unknown function  $f(x)$  at  $x=x_0$ , given data point pairs  $(x,y)$  in the
%%     form of a  $x$  data vector and a  $y$  data vector. For a given data pair
%%     (say the  $i$ 'th pair), we have  $y_i = f(x_i)$ . It is assumed that the  $x$ 
%%     data values are monotonically increasing. If the first or last  $x$  is
%%     outside of the range of the  $x$  data vector, then the first or last
%%     point will be returned.
%%
%%     This function returns the "nearest"  $y_0$  point for a given  $x_0$ .
%%     No interpolation is performed.
%%
%%     The S-function parameters are:
%%         XData
%%         YData
%%         XEvenlySpaced: 0 or 1
%%     The third parameter cannot be changed during execution and is
%%     written to the model.rtw file in XSpacing filed of the SFcnParamSettings
%%     record as "EvenlySpaced" or "UnEvenlySpaced". The first two parameters
%%     can change during execution and show up in the parameter vector.
%%
%function Outputs(block, system) Output
    /* %<Type> Block: %<Name> */
    {
        %assign rollVars = ["U", "Y"]
        %%
        %% Load XData and YData as local variables
        %%
        const real_T *xData = %<LibBlockParameterAddr(XData, "", "", 0)>;
        const real_T *yData = %<LibBlockParameterAddr(YData, "", "", 0)>;
        %assign xDataLen = SIZE(XData.Value, 1)
        %%
        %% When the XData is evenly spaced, we use the direct lookup algorithm
        %% to locate the lookup index.

```

```
%%
%if SFcnParamSettings.XSpacing == "EvenlySpaced"
    real_T spacing = xData[1] - xData[0];

    %roll idx = RollRegions, lcv = RollThreshold, block, "Roller", rollVars
    %assign u = LibBlockInputSignal(0, "", lcv, idx)
    %assign y = LibBlockOutputSignal(0, "", lcv, idx)
    if ( %<u> <= xData[0] ) {
        %<y> = yData[0];
    } else if ( %<u> >= yData[%<xDataLen-1>] ) {
        %<y> = yData[%<xDataLen-1>];
    } else {
        int_T idx = (int_T)( ( %<u> - xData[0] ) / spacing );
        %<y> = yData[idx];
    }
}
%%
%% Generate an empty line if we are not rolling,
%% so that it looks nice in the generated code.
%%
%if lcv == ""

%endif
%endroll
%else
%% When the XData is unevenly spaced, we use a bisection search to
%% locate the lookup index.
int_T idx;

%assign xDataAddr = LibBlockParameterAddr(XData, "", "", 0)
%roll idx = RollRegions, lcv = RollThreshold, block, "Roller", rollVars
%assign u = LibBlockInputSignal(0, "", lcv, idx)
idx = GetDirectLookupIndex(xData, %<xDataLen>, %<u>);
%assign y = LibBlockOutputSignal(0, "", lcv, idx)
%<y> = yData[idx];
%%
%% Generate an empty line if we are not rolling,
%% so that it looks nice in the generated code.
%%
%if lcv == ""
```

```

        %endif
    %endroll
    %endif
}
%endfunction
%% EOF: sfun_directlook.tlc

```

## Guidelines for Writing Inlined S-Functions

- Consider using the block property `RTWdata` (see “S-Function RTWdata” on page 14-67). This property is a structure of strings that you can associate with a block. The code generator saves the structure with the model in the `model.rtw` file and makes the `.rtw` file more readable. For example, suppose you enter the following commands in the MATLAB Command Window:

```

mydata.field1 = 'information for field1';
mydata.field2 = 'information for field2';
set_param(sfun_block, 'RTWdata', mydata);

```

The `.rtw` file that Simulink Coder generates for the block, will include the comments specified in the structure `mydata`.

- Consider using the `mdlRTW` function to inline your C MEX S-function in the generated code. This is useful when you want to
  - Rename tunable parameters in the generated code
  - Introduce nontunable parameters into a TLC file

## Write S-Functions That Support Expression Folding

- “About S-Functions that Support Expression Folding” on page 14-92
- “Categories of Output Expressions” on page 14-93
- “Acceptance or Denial of Requests for Input Expressions” on page 14-98
- “Expression Folding in a TLC Block Implementation” on page 14-100

## About S-Functions that Support Expression Folding

This section describes how you can take advantage of expression folding to increase the efficiency of code generated by your own inlined S-Function blocks, by calling macros provided in the S-Function API. This section assumes that you are familiar with:

- Writing inlined S-functions (see “S-Function Basics”).
- “Target Language Compiler”

The S-Function API lets you specify whether a given S-Function block should nominally accept expressions at a given input port. A block should not always accept expressions. For example, if the address of the signal at the input is used, expressions should not be accepted at that input, because it is not possible to take the address of an expression.

The S-Function API also lets you specify whether an expression can represent the computations associated with a given output port. When you request an expression at a block’s input or output port, the Simulink engine determines whether or not it can honor that request, given the block’s context. For example, the engine might deny a block’s request to output an expression if the destination block does not accept expressions at its input, if the destination block has an update function, or if multiple output destinations exist.

The decision to honor or deny a request to output an expression can also depend on the category of output expression the block uses (see “Categories of Output Expressions” on page 14-93).

The sections that follow explain

- When and how you can request that a block accept expressions at an input port
- When and how you can request that a block generate expressions at an output
- The conditions under which the Simulink engine will honor or deny such requests

To take advantage of expression folding in your S-functions, you should understand when to request acceptance and generation of expressions for

specific blocks. You do not have to understand the algorithm by which the Simulink engine chooses to accept or deny these requests. However, if you want to trace between the model and the generated code, it is helpful to understand some of the more common situations that lead to denial of a request.

## Categories of Output Expressions

When you implement a C MEX S-function, you can specify whether the code corresponding to a block's output is to be generated as an expression. If the block generates an expression, you must specify that the expression is *constant*, *trivial*, or *generic*.

A *constant* output expression is a direct access to one of the block's parameters. For example, the output of a Constant block is defined as a constant expression because the output expression is simply a direct access to the block's Value parameter.

A *trivial* output expression is an expression that can be repeated, without any performance penalty, when the output port has multiple output destinations. For example, the output of a Unit Delay block is defined as a trivial expression because the output expression is simply a direct access to the block's state. Because the output expression involves no computations, it can be repeated more than once without degrading the performance of the generated code.

A *generic* output expression is an expression that should be assumed to have a performance penalty if repeated. As such, a generic output expression is not suitable for repeating when the output port has multiple output destinations. For instance, the output of a Sum block is a generic rather than a trivial expression because it is costly to recompute a Sum block output expression as an input to multiple blocks.

**Examples of Trivial and Generic Output Expressions.** Consider the following block diagram. The Delay block has multiple destinations, yet its output is designated as a trivial output expression, so that it can be used more than once without degrading the efficiency of the code.

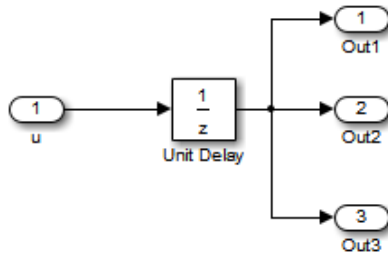

The following code excerpt shows code generated from the Unit Delay block in this block diagram. The three root outputs are directly assigned from the state of the Unit Delay block, which is stored in a field of the global data structure `rtDWork`. Since the assignment is direct, involving no expressions, there is no performance penalty associated with using the trivial expression for multiple destinations.

```
void Md1Outputs(int_T tid)
{
    ...
    /* Outport: <Root>/Out1 incorporates:
     *   UnitDelay: <Root>/Unit Delay */
    rtY.Out1 = rtDWork.Unit_Delay_DSTATE;

    /* Outport: <Root>/Out2 incorporates:
     *   UnitDelay: <Root>/Unit Delay */
    rtY.Out2 = rtDWork.Unit_Delay_DSTATE;

    /* Outport: <Root>/Out3 incorporates:
     *   UnitDelay: <Root>/Unit Delay */
    rtY.Out3 = rtDWork.Unit_Delay_DSTATE;

    ...
}
```

On the other hand, consider the Sum blocks in the following model:

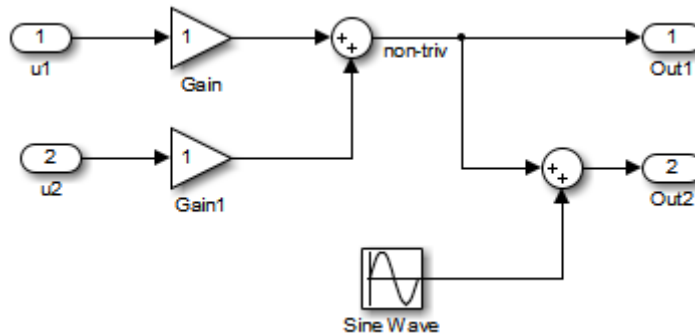

The upper Sum block in the preceding model generates the signal labeled `non_triv`. Computation of this output signal involves two multiplications and an addition. If the Sum block's output were permitted to generate an expression even when the block had multiple destinations, the block's operations would be duplicated in the generated code. In the case illustrated, the generated expressions would proliferate to four multiplications and two additions. This would degrade the efficiency of the program. Accordingly the output of the Sum block is not allowed to be an expression because it has multiple destinations

The code generated for the previous block diagram shows how code is generated for Sum blocks with single and multiple destinations.

The Simulink engine does not permit the output of the upper Sum block to be an expression because the signal `non_triv` is routed to two output destinations. Instead, the result of the multiplication and addition operations is stored in a temporary variable (`rtb_non_triv`) that is referenced twice in the statements that follow, as seen in the code excerpt below.

In contrast, the lower Sum block, which has only a single output destination (`Out2`), does generate an expression.

```
void MdlOutputs(int_T tid)
{
    /* local block i/o variables */
    real_T rtb_non_triv;
    real_T rtb_Sine_Wave;
```

```
/* Sum: <Root>/Sum incorporates:
 * Gain: <Root>/Gain
 * Inport: <Root>/u1
 * Gain: <Root>/Gain1
 * Inport: <Root>/u2
 *
 * Regarding <Root>/Gain:
 * Gain value: rtP.Gain_Gain
 *
 * Regarding <Root>/Gain1:
 * Gain value: rtP.Gain1_Gain
 */
rtb_non_triv = (rtP.Gain_Gain * rtU.u1) + (rtP.Gain1_Gain *
rtU.u2);

/* Outport: <Root>/Out1 */
rtY.Out1 = rtb_non_triv;

/* Sin Block: <Root>/Sine Wave */

rtb_Sine_Wave = rtP.Sine_Wave_Amp *
sin(rtP.Sine_Wave_Freq * rtmGetT(rtM_model) +
rtP.Sine_Wave_Phase) + rtP.Sine_Wave_Bias;

/* Outport: <Root>/Out2 incorporates:
 * Sum: <Root>/Sum1
 */
rtY.Out2 = (rtb_non_triv + rtb_Sine_Wave);
}
```

**Specify the Category of an Output Expression.** The S-Function API provides macros that let you declare whether an output of a block should be an expression, and if so, to specify the category of the expression. The following table specifies when to declare a block output to be a constant, trivial, or generic output expression.



## Types of Output Expressions

Category of Expression	When to Use
Constant	Use only if block output is a direct memory access to a block parameter.
Trivial	Use only if block output is an expression that can appear multiple times in the code without reducing efficiency (for example, a direct memory access to a field of the DWork vector, or a literal).
Generic	Use if output is an expression, but not constant or trivial.

You must declare outputs as expressions in the `mdlSetWorkWidths` function using macros defined in the S-Function API. The macros have the following arguments:

- `SimStruct *S`: pointer to the block's `SimStruct`.
- `int idx`: zero-based index of the output port.
- `bool value`: pass in `TRUE` if the port generates output expressions.

The following macros are available for setting an output to be a constant, trivial, or generic expression:

- `void ssSetOutputPortConstOutputExprInRTW(SimStruct *S, int idx, bool value)`
- `void ssSetOutputPortTrivialOutputExprInRTW(SimStruct *S, int idx, bool value)`
- `void ssSetOutputPortOutputExprInRTW(SimStruct *S, int idx, bool value)`

The following macros are available for querying the status set by any prior calls to the macros above:

- `bool ssGetOutputPortConstOutputExprInRTW(SimStruct *S, int idx)`
- `bool ssGetOutputPortTrivialOutputExprInRTW(SimStruct *S, int idx)`
- `bool ssGetOutputPortOutputExprInRTW(SimStruct *S, int idx)`

The set of generic expressions is a superset of the set of trivial expressions, and the set of trivial expressions is a superset of the set of constant expressions.

Therefore, when you query an output that has been set to be a constant expression with `ssGetOutputPortTrivialOutputExprInRTW`, it returns `True`. A constant expression is considered a trivial expression, because it is a direct memory access that can be repeated without degrading the efficiency of the generated code.

Similarly, an output that has been configured to be a constant or trivial expression returns `True` when queried for its status as a generic expression.

### **Acceptance or Denial of Requests for Input Expressions**

A block can request that its output be represented in code as an expression. Such a request can be denied if the destination block cannot accept expressions at its input port. Furthermore, conditions independent of the requesting block and its destination blocks can prevent acceptance of expressions.

This section discusses block-specific conditions under which requests for input expressions are denied. For information on other conditions that prevent acceptance of expressions, see “Denial of Block Requests to Output Expressions” on page 14-99.

A block should not be configured to accept expressions at its input port under the following conditions:

- The block must take the address of its input data. It is not possible to take the address of most types of input expressions.
- The code generated for the block references the input more than once (for example, the `Abs` or `Max` blocks). This would lead to duplication of a potentially complex expression and a subsequent degradation of code efficiency.

If a block refuses to accept expressions at an input port, then any block that is connected to that input port is not permitted to output a generic or trivial expression.

A request to output a constant expression is never denied, because there is no performance penalty for a constant expression, and it is always possible to take the parameter's address.

**S-Function API to Specify Input Expression Acceptance.** The S-Function API provides macros that let you:

- Specify whether a block input should accept nonconstant expressions (that is, trivial or generic expressions)
- Query whether a block input accepts nonconstant expressions

By default, block inputs do not accept nonconstant expressions.

You should call the macros in your `mdlSetWorkWidths` function. The macros have the following arguments:

- `SimStruct *S`: pointer to the block's `SimStruct`.
- `int idx`: zero-based index of the input port.
- `bool value`: pass in `TRUE` if the port accepts input expressions; otherwise pass in `FALSE`.

The macro available for specifying whether or not a block input should accept a nonconstant expression is as follows:

```
void ssSetInputPortAcceptExprInRTW(SimStruct *S, int portIdx, bool value)
```

The corresponding macro available for querying the status set by any prior calls to `ssSetInputPortAcceptExprInRTW` is as follows:

```
bool ssGetInputPortAcceptExprInRTW(SimStruct *S, int portIdx)
```

**Denial of Block Requests to Output Expressions.** Even after a specific block requests that it be allowed to generate an output expression, that request can be denied for generic reasons. These reasons include, but are not limited to

- The output expression is nontrivial, and the output has multiple destinations.
- The output expression is nonconstant, and the output is connected to at least one destination that does not accept expressions at its input port.
- The output is a test point.
- The output has been assigned an external storage class.
- The output must be stored using global data (for example is an input to a merge block or a block with states).
- The output signal is complex.

You do not need to consider these generic factors when deciding whether or not to utilize expression folding for a particular block. However, these rules can be helpful when you are examining generated code and analyzing cases where the expression folding optimization is suppressed.

### **Expression Folding in a TLC Block Implementation**

To take advantage of expression folding, you must modify the TLC block implementation of an inlined S-Function such that it informs the Simulink engine whether it generates or accepts expressions at its

- Input ports, as explained in “S-Function API to Specify Input Expression Acceptance” on page 14-99.
- Output ports, as explained in “Categories of Output Expressions” on page 14-93.

This section discusses required modifications to the TLC implementation.

**Expression Folding Compliance.** In the `BlockInstanceSetup` function of your S-function, register your block to be compliant with expression folding. Otherwise, any expression folding requested or allowed at the block’s outputs or inputs will be disabled, and temporary variables will be used.

To register expression folding compliance, call the TLC library function `LibBlockSetIsExpressionCompliant(block)`, which is defined in `matlabroot/rtw/c/tlc/lib/utillib.tlc`. For example:

```

%% Function: BlockInstanceSetup =====
%%
%function BlockInstanceSetup(block, system) void
    %%
    %<LibBlockSetIsExpressionCompliant(block)>
    %%
%endfunction

```

You can conditionally disable expression folding at the inputs and outputs of a block by making the call to this function conditionally.

If you have overridden one of the TLC block implementations provided by the Simulink Coder product with your own implementation, you should not make the preceding call until you have updated your implementation, as described by the guidelines for expression folding in the following sections.

**Output Expressions.** The `BlockOutputSignal` function is used to generate code for a scalar output expression or one element of a nonscalar output expression. If your block outputs an expression, you should add a `BlockOutputSignal` function. The prototype of the `BlockOutputSignal` is

```
%function BlockOutputSignal(block,system,portIdx,ucv,lcx,idx,retType) void
```

The arguments to `BlockOutputSignal` are as follows:

- `block`: the record for the block for which an output expression is being generated
- `system`: the record for the system containing the block
- `portIdx`: zero-based index of the output port for which an expression is being generated
- `ucv`: user control variable defining the output element for which code is being generated
- `lcx`: loop control variable defining the output element for which code is being generated
- `idx`: signal index defining the output element for which code is being generated
- `retType`: string defining the type of signal access desired:

"Signal" specifies the contents or address of the output signal.

"SignalAddr" specifies the address of the output signal

The BlockOutputSignal function returns a text string for the output signal or address. The string should enforce the precedence of the expression by using opening and terminating parentheses, unless the expression consists of a function call. The address of an expression can only be returned for a constant expression; it is the address of the parameter whose memory is being accessed. The code implementing the BlockOutputSignal function for the Constant block is shown below.

```
%% Function: BlockOutputSignal =====
%% Abstract:
%%     Return the reference to the parameter. This function *may*
%%     be used by Simulink when optimizing the Block IO data structure.
%%
%function BlockOutputSignal(block,system,portIdx,ucv,lcx,idx,retType) void
    %switch retType
        %case "Signal"
            %return LibBlockParameter(Value,ucv,lcx,idx)
        %case "SignalAddr"
            %return LibBlockParameterAddr(Value,ucv,lcx,idx)
        %default
            %assign errTxt = "Unsupported return type: %<retType>"
            %<LibBlockReportError(block,errTxt)>
    %endswitch
%endfunction
```

The code implementing the BlockOutputSignal function for the Relational Operator block is shown below.

```
%% Function: BlockOutputSignal =====
%% Abstract:
%%     Return an output expression. This function *may*
%%     be used by Simulink when optimizing the Block IO data structure.
%%
%function BlockOutputSignal(block,system,portIdx,ucv,lcx,idx,retType) void
%switch retType
%case "Signal"
%assign logicOperator = ParamSettings.Operator
```

```

    %if ISEQUAL(logicOperator, "~=")
    %assign op = "!="
    elseif ISEQUAL(logicOperator, "==") %assign op = "=="
    %else
    %assign op = logicOperator
    %endif
    %assign u0 = LibBlockInputSignal(0, ucv, lcv, idx)
    %assign u1 = LibBlockInputSignal(1, ucv, lcv, idx)
    %return "(%<u0> %<op> %<u1>)"
    %default
    %assign errTxt = "Unsupported return type: %<retType>"
    %<LibBlockReportError(block,errTxt)>
    %endswitch
    %endfunction

```

**Expression Folding for Blocks with Multiple Outputs.** When a block has a single output, the `Outputs` function in the block's TLC file is called only if the output port is not an expression. Otherwise, the `BlockOutputSignal` function is called.

If a block has multiple outputs, the `Outputs` function is called if any output port is not an expression. The `Outputs` function should guard against generating code for output ports that are expressions. This is achieved by guarding sections of code corresponding to individual output ports with calls to `LibBlockOutputSignalIsExpr()`.

For example, consider an S-Function with two inputs and two outputs, where

- The first output,  $y_0$ , is equal to two times the first input.
- The second output,  $y_1$ , is equal to four times the second input.

The `Outputs` and `BlockOutputSignal` functions for the S-function are shown in the following code excerpt.

```

%% Function: BlockOutputSignal =====
%% Abstract:
%%     Return an output expression. This function *may*
%%     be used by Simulink when optimizing the Block IO data structure.
%%
%function BlockOutputSignal(block,system,portIdx,ucv,lcv,idx,retType) void

```

```

%switch retType
%case "Signal"
    %assign u = LibBlockInputSignal(portIdx, ucv, lcv, idx)
%case "Signal"
    %if portIdx == 0
        %return "(2 * %<u>)"
    %elseif portIdx == 1
        %return "(4 * %<u>)"
    %endif
%default
%assign errTxt = "Unsupported return type: %<retType>"
    %<LibBlockReportError(block,errTxt)>
%endswitch
%endfunction
%%
%% Function: Outputs =====
%% Abstract:
%%     Compute output signals of block
%%
%function Outputs(block,system) Output
%assign rollVars = ["U", "Y"]
%roll sigIdx = RollRegions, lcv = RollThreshold, block, "Roller", rollVars
%assign u0 = LibBlockInputSignal(0, "", lcv, sigIdx)
    %assign u1 = LibBlockInputSignal(1, "", lcv, sigIdx)
    %assign y0 = LibBlockOutputSignal(0, "", lcv, sigIdx)
    %assign y1 = LibBlockOutputSignal(1, "", lcv, sigIdx)
%if !LibBlockOutputSignalIsExpr(0)
    %<y0> = 2 * %<u0>;
%endif
%if !LibBlockOutputSignalIsExpr(1)
    %<y1> = 4 * %<u1>;
%endif
%endroll
%endfunction

```

**Comments for Blocks That Are Expression-Folding-Compliant.** In the past, all blocks preceded their outputs code with comments of the form

```
/* %<Type> Block: %<Name> */
```



When a block is expression-folding-compliant, the initial line shown above is generated automatically. You should not include the comment as part of the block's TLC implementation. Additional information should be registered using the `LibCacheBlockComment` function.

The `LibCacheBlockComment` function takes a string as an input, defining the body of the comment, except for the opening header, the final newline of a single or multiline comment, and the closing trailer.

The following TLC code illustrates registering a block comment. Note the use of the function `LibBlockParameterForComment`, which returns a string, suitable for a block comment, specifying the value of the block parameter.

```
%openfile commentBuf
    $c(*) Gain value: %<LibBlockParameterForComment(Gain)>
%closefile commentBuf
    %<LibCacheBlockComment(block, commentBuf)>
```

## S-Functions That Specify Port Scope and Reusability

You can use the following `SimStruct` macros in the `mdlInitializeSizes` method to specify the scope and reusability of the memory used for your S-function's input and output ports:

- `ssSetInputPortOptimOpts`: Specify the scope and reusability of the memory allocated to an S-function input port
- `ssSetOutputPortOptimOpts`: Specify the scope and reusability of the memory allocated to an S-function output port
- `ssSetInputPortOverWritable`: Specify whether one of your S-function's input ports can be overwritten by one of its output ports
- `ssSetOutputPortOverwritesInputPort`: Specify whether an output port can share its memory buffer with an input port

You declare an input or output as local or global, and indicate its reusability, by passing one of the following four options to the `ssSetInputPortOptimOpts` and `ssSetOutputPortOptimOpts` macros:

- `SS_NOT_REUSABLE_AND_GLOBAL`: Indicates that the input and output ports are stored in separate memory locations in the global block input and output structure
- `SS_NOT_REUSABLE_AND_LOCAL`: Indicates that the Simulink Coder software can declare individual local variables for the input and output ports
- `SS_REUSABLE_AND_LOCAL`: Indicates that the Simulink Coder software can reuse a single local variable for these input and output ports
- `SS_REUSABLE_AND_GLOBAL`: Indicates that these input and output ports are stored in a single element in the global block input and output structure

---

**Note** Marking an input or output port as a local variable does not imply that the code generator uses a local variable in the generated code. If your S-function accesses the inputs and outputs only in its `mdlOutputs` routine, the code generator declares the inputs and outputs as local variables. However, if the inputs and outputs are used elsewhere in the S-function, the code generator includes them in the global block input and output structure.

---

The reusability setting indicates if the memory associated with an input or output port can be overwritten. To reuse input and output port memory:

- 1** Indicate the ports are reusable using either the `SS_REUSABLE_AND_LOCAL` or `SS_REUSABLE_AND_GLOBAL` option in the `ssSetInputPortOptimOpts` and `ssSetOutputPortOptimOpts` macros
- 2** Indicate the input port memory is overwritable using `ssSetInputPortOverWritable`
- 3** If your S-function has multiple input and output ports, use `ssSetOutputPortOverwritesInputPort` to indicate which output and input ports share memory

The following example shows how different scope and reusability settings effect the generated code. The following model contains an S-function block pointing to the C MEX S-function `matlabroot/toolbox/simulink/simdemos/simfeatures/src/sfun_directlook.c`, which models a direct 1-D lookup table.

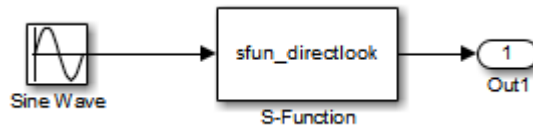

The S-function's `mdlInitializeSizes` method declares the input port as reusable, local, and overwriteable and the output port as reusable and local, as follows:

```

static void mdlInitializeSizes(SimStruct *S)
{
  /* snip */
  ssSetInputPortOptimOpts(S, 0, SS_REUSABLE_AND_LOCAL);
  ssSetInputPortOverWritable(S, 0, TRUE);

  /* snip */
  ssSetOutputPortOptimOpts(S, 0, SS_REUSABLE_AND_LOCAL);

  /* snip */
}
  
```

The generated code for this model stores the input and output signals in a single local variable `rtb_SFunction`, as shown in the following output function:

```

static void sl_directlook_output(int_T tid)
{
  /* local block i/o variables */
  real_T rtb_SFunction[2];

  /* Sin: '<Root>/Sine Wave' */
  rtb_SFunction[0] = sin(((real_T)sl_directlook_DWork.counter[0] +
    sl_directlook_P.SineWave_Offset) * 2.0 * 3.1415926535897931E+000 /
    sl_directlook_P.SineWave_NumSamp) * sl_directlook_P.SineWave_Amp[0] +
    sl_directlook_P.SineWave_Bias;
  rtb_SFunction[1] = sin(((real_T)sl_directlook_DWork.counter[1] +
    sl_directlook_P.SineWave_Offset) * 2.0 * 3.1415926535897931E+000 /
    sl_directlook_P.SineWave_NumSamp) * sl_directlook_P.SineWave_Amp[1] +
    sl_directlook_P.SineWave_Bias;
}
  
```

```

/* S-Function Block: <Root>/S-Function */
{
  const real_T *xData = &sl_directlook_P.SFunction_XData[0];
  const real_T *yData = &sl_directlook_P.SFunction_YData [0];
  real_T spacing = xData[1] - xData[0];
  if (rtb_SFunction[0] <= xData[0] ) {
    rtb_SFunction[0] = yData[0];
  } else if (rtb_SFunction[0] >= yData[20] ) {
    rtb_SFunction[0] = yData[20];
  } else {
    int_T idx = (int_T)( ( rtb_SFunction[0] - xData[0] ) / spacing );
    rtb_SFunction[0] = yData[idx];
  }

  if (rtb_SFunction[1] <= xData[0] ) {
    rtb_SFunction[1] = yData[0];
  } else if (rtb_SFunction[1] >= yData[20] ) {
    rtb_SFunction[1] = yData[20];
  } else {
    int_T idx = (int_T)( ( rtb_SFunction[1] - xData[0] ) / spacing );
    rtb_SFunction[1] = yData[idx];
  }
}

/* Output: '<Root>/Out1' */
sl_directlook_Y.Out1[0] = rtb_SFunction[0];
sl_directlook_Y.Out1[1] = rtb_SFunction[1];
UNUSED_PARAMETER(tid);
}

```

The following table shows variations of the code generated for this model when using the generic real-time target (GRT). Each row explains a different setting for the scope and reusability of the S-function's input and output ports.

Scope and reusability	S-function mdlInitializeSizes code	Generated code
<b>Inputs:</b> Local, reusable, overwriteable <b>Outputs:</b> Local, reusable	<pre> ssSetInputPortOptimOpts(S, 0, SS_REUSABLE_AND_LOCAL);  ssSetInputPortOverWritable(S, 0, TRUE);  ssSetOutputPortOptimOpts(S, 0, SS_REUSABLE_AND_LOCAL); </pre>	<p>The <i>model.c</i> file declares a local variable in the output function.</p> <pre> /* local block i/o variables */ real_T rtb_SFunction[2]; </pre>
<b>Inputs:</b> Global, reusable, overwriteable <b>Outputs:</b> Global, reusable	<pre> ssSetInputPortOptimOpts(S, 0, SS_REUSABLE_AND_GLOBAL);  ssSetInputPortOverWritable(S, 0, TRUE);  ssSetOutputPortOptimOpts(S, 0, SS_REUSABLE_AND_GLOBAL); </pre>	<p>The <i>model.h</i> file defines a block signals structure with a single element to store the S-function's input and output.</p> <pre> /* Block signals (auto storage) */ typedef struct {     real_T SFunction[2]; } BlockIO_sl_directlook; </pre> <p>The <i>model.c</i> file uses this element of the structure in calculations of the S-function's input and output signals.</p> <pre> /* Sin: '&lt;Root&gt;/Sine Wave' */ sl_directlook_B.SFunction[0] = sin ... /* snip */ /*S-Function Block:&lt;Root&gt;/S-Function*/ { const real_T *xData =     &amp;sl_directlook_P.SFunction_XData[0] </pre>

Scope and reusability	S-function mdlInitializeSizes code	Generated code
<p><b>Inputs:</b> Local, not reusable  <b>Outputs:</b> Local, not reusable</p>	<pre>ssSetInputPortOptimOpts(S, 0, SS_NOT_REUSABLE_AND_LOCAL);  ssSetInputPortOverWritable(S, 0, FALSE);  ssSetOutputPortOptimOpts(S, 0, SS_NOT_REUSABLE_AND_LOCAL);</pre>	<p>The <i>model.c</i> file declares local variables for the S-function's input and output in the output function</p> <pre>/* local block i/o variables */ real_T rtb_SineWave[2]; real_T rtb_SFunction[2];</pre>
<p><b>Inputs:</b> Global, not reusable  <b>Outputs:</b> Global, not reusable</p>	<pre>ssSetInputPortOptimOpts(S, 0, SS_NOT_REUSABLE_AND_GLOBAL);  ssSetInputPortOverWritable(S, 0, FALSE);  ssSetOutputPortOptimOpts(S, 0, SS_NOT_REUSABLE_AND_GLOBAL);</pre>	<p>The <i>model.h</i> file defines a block signal structure with individual elements to store the S-function's input and output.</p> <pre>/* Block signals (auto storage) */ typedef struct {     real_T SineWave[2];     real_T SFunction[2]; } BlockIO_sl_directlook;</pre> <p>The <i>model.c</i> file uses the different elements in this structure when calculating the S-function's input and output.</p> <pre>/* Sin: '&lt;Root&gt;/Sine Wave' */ sl_directlook_B.SineWave[0] = sin ... /* snip */ /*S-Function Block:&lt;Root&gt;/S-Function*/ { const real_T *xData =     &amp;sl_directlook_P.SFunction_XData[0]</pre>

## S-Functions That Specify Sample Time Inheritance Rules

For the Simulink engine to determine whether a model can inherit a sample time, the S-functions in the model need to specify how they use sample times. You can specify this information by calling the macro `ssSetModelReferenceSampleTimeInheritanceRule` from `mdlInitializeSizes` or `mdlSetWorkWidths`. To use this macro:

- 1** Check whether the S-function calls any of the following macros:
  - `ssGetSampleTime`
  - `ssGetInputPortSampleTime`
  - `ssGetOutputPortSampleTime`
  - `ssGetInputPortOffsetTime`
  - `ssGetOutputPortOffsetTime`
  - `ssGetSampleTimePtr`
  - `ssGetInputPortSampleTimeIndex`
  - `ssGetOutputPortSampleTimeIndex`
  - `ssGetSampleTimeTaskID`
  - `ssGetSampleTimeTaskIDPtr`
- 2** Check for the following in your S-function TLC code:
  - `LibBlockSampleTime`
  - `CompiledModel.SampleTime`
  - `LibBlockInputSignalSampleTime`
  - `LibBlockInputSignalOffsetTime`
  - `LibBlockOutputSignalSampleTime`
  - `LibBlockOutputSignalOffsetTime`
- 3** Depending on your search results, use `ssSetModelReferenceSampleTimeInheritanceRule` as indicated in the following table.

If...	Use...
None of the macros or functions are present, the S-function does not preclude the model from inheriting a sample time.	<pre>ssSetModelReferenceSampleTimeInheritanceRule (S, USE_DEFAULT_FOR_DISCRETE_INHERITANCE)</pre>
Any of the macros or functions are used for <ul style="list-style-type: none"> <li>• Throwing errors if sample time is inherited, continuous, or constant</li> <li>• Checking <code>ssIsSampleHit</code></li> <li>• Checking whether sample time is inherited in either <code>mdlSetInputPortSampleTime</code> or <code>mdlSetOutputPortSampleTime</code> before setting</li> </ul>	<pre>ssSetModelReferenceSampleTimeInheritanceRule... (S,USE_DEFAULT_FOR_DISCRETE_INHERITANCE)</pre>
The S-function uses its sample time for computing parameters, outputs, and so on	<pre>ssSetModelReferenceSampleTimeInheritanceRule (S, DISALLOW_SAMPLE_TIME_INHERITANCE)</pre>

---

**Note** If an S-function does not set the `ssSetModelReferenceSampleTimeInheritanceRule` macro, by default the Simulink engine assumes that the S-function does not preclude the model containing that S-function from inheriting a sample time. However, the engine issues a warning indicating that the model includes S-functions for which this macro is not set.

---

You can use settings on the **Diagnostics/Solver** pane of the Configuration Parameters dialog box or Model Explorer to control how the Simulink engine responds when it encounters S-functions that have unspecified sample time inheritance rules. Toggle the **Unspecified inheritability of sample time** diagnostic to none, warning, or error. The default is warning.



## S-Functions That Support Code Reuse

You can reuse the generated code for identical subsystems that occur in multiple instances within a model and across referenced models. For more information about code generation of subsystems for code reuse, see “Code Generation of Subsystems” on page 2-2. If you want your S-function to support code reuse for a subsystem, the S-function must meet the following requirements:

- The S-function must be inlined.
- Code generated from the S-function must not use static variables.
- The S-function must initialize its pointer work vector in `mdlStart` and not before.
- The S-function must not be a sink that logs data to the workspace.
- The S-function must register its parameters as run-time parameters in `mdlSetWorkWidths`. (It must not use `ssWriteRTWParameters` in its `mdlRTW` function for this purpose.)
- The S-function must not be a device driver.

In addition to meeting the preceding requirements, your S-function must set the `SS_OPTION_WORKS_WITH_CODE_REUSE` flag (see the description of `ssSetOptions` in the Simulink Writing S-Function documentation). This flag indicates that your S-function meets the requirements for subsystem code reuse.

## S-Functions for Multirate Multitasking Environments

- “About S-Functions for Multirate Multitasking Environments” on page 14-113
- “Rate Grouping Support in S-Functions” on page 14-114
- “Create Multitasking, Multirate, Port-Based Sample Time S-Functions” on page 14-115

### About S-Functions for Multirate Multitasking Environments

S-functions can be used in models with multiple sample rates and deployed in multitasking target environments. Likewise, S-functions themselves can have

multiple rates at which they operate. The Embedded Coder product generates code for multirate multitasking models using an approach called *rate grouping*. In code generated for ERT-based targets, rate grouping generates separate *model\_step* functions for the base rate task and each subrate task in the model. Although rate grouping is a code generation feature found in ERT targets only, your S-functions can use it in other contexts when you code them as explained below.

### Rate Grouping Support in S-Functions

To take advantage of rate grouping, you must inline your multirate S-functions if you have not done so. You need to follow certain Target Language Compiler protocols to exploit rate grouping. Coding TLC to exploit rate grouping does not prevent your inlined S-functions from functioning properly in GRT. Likewise, your inlined S-functions will still generate valid ERT code even if you do not make them rate-grouping-compliant. If you do so, however, they will generate more efficient code for multirate models.

For instructions and examples of Target Language Compiler code illustrating how to create and upgrade S-functions to generate rate-grouping-compliant code, see “Rate Grouping Compliance and Compatibility Issues” in the Embedded Coder documentation.

For each multirate S-function that is not rate grouping-compliant, the Simulink Coder software issues the following warning when you build:

```
Warning: Simulink Coder: Code of output function for multirate block
'<Root>/S-Function' is guarded by sample hit checks rather than being rate
grouped. This will generate the same code for all rates used by the block,
possibly generating dead code. To avoid dead code, you must update the TLC
file for the block.
```

You will also find a comment such as the following in code generated for each noncompliant S-function:

```
/* Because the output function of multirate block
   <Root>/S-Function is not rate grouped,
   the following code might contain unreachable blocks of code.
   To avoid this, you must update your block TLC file. */
```

The words “update function” are substituted for “output function” in these warnings.

### **Create Multitasking, Multirate, Port-Based Sample Time S-Functions**

The following instructions show how to support both data determinism and data integrity in multirate S-functions. They do not cover cases where there is no determinism nor integrity. Support for frame-based processing does not affect the requirements.

---

**Note** The slow rates must be multiples of the fastest rate. The instructions do not apply when two rates being interfaced are not multiples or when the rates are not periodic.

---

**Rules for Properly Handling Fast-to-Slow Transitions.** The rules that multirate S-functions should observe for inputs are

- The input should only be read at the rate that is associated with the input port sample time.
- Generally, the input data is written to DWork, and the DWork can then be accessed at the slower (downstream) rate.

The input can be read at every sample hit of the input rate and written into DWork memory, but this DWork memory cannot then be directly accessed by the slower rate. Any DWork memory that will be read by the slow rate must only be written by the fast rate when there is a *special sample hit*. A special sample hit occurs when both this input port rate and rate to which it is interfacing have a hit. Depending on their requirements and design, algorithms can process the data in several locations.

The rules that multirate S-functions should observe for outputs are

- The output should not be written by any rate other than the rate assigned to the output port, except in the optimized case described below.
- The output should always be written when the sample rate of the output port has a hit.

If these conditions are met, the S-Function block can specify that the input port and output port can both be made local and reusable.

You can include an optimization when little or no processing needs to be done on the data. In such cases, the input rate code can directly write to the output (instead of by using `DWork`) when there is a special sample hit. If you do this, however, you must declare the output port to be *global* and *not reusable*. This optimization results in one less `memcpy` but does introduce nonuniform processing requirements on the faster rate.

Whether you use this optimization or not, the most recent input data, as seen by the slower rate, is always the value when both the faster and slower rate had their hits (and possible earlier input data as well, depending on the algorithm). Any subsequent steps by the faster rate and the associated input data updates are not seen by the slower rate until the next hit for the slow rate occurs.

**Pseudocode Examples of Fast-to-Slow Rate Transition.** The pseudocode below abstracts how you should write your C MEX code to handle fast-to-slow transitions, illustrating with an input rate of 0.1 second driving an output rate of one second. A similar approach can be taken when inlining the code. The block has following characteristics:

- File: `sfun_multirate_zoh.c`, Equation:  $y = u(ts_{\text{slow}})$
- Input: local and reusable
- Output: local and reusable
- DirectFeedthrough: yes

```
OutputFcn
if (ssIsSampleHit(".1")) {
    if (ssIsSpecialSampleHit("1")) {
        DWork = u;
    }
}
if (ssIsSampleHit("1")) {
    y = DWork;
}
```

An alternative, slightly optimized approach for simple algorithms:

- Input: local and reusable
- Output: global and not reusable because it needs to persist between special sample hits
- DirectFeedthrough: yes

```
OutputFcn
if (ssIsSampleHit(".1")) {
    if (ssIsSpecialSampleHit("1")) {
        y = u;
    }
}
```

Example adding a simple algorithm:

- File: sfun\_multirate\_avg.c; Equation:  $y = \text{average}(u)$
- Input: local and reusable
- Output: local and reusable
- DirectFeedthrough: yes

(Assume DWork[0:10] and DWork[mycounter] are initialized to zero)

```
OutputFcn
if (ssIsSampleHit(".1")) {
    /* In general, processing on 'u' could be done here,
       it runs on every hit of the fast rate. */
    DWork[DWork[mycounter]++] = u;
    if (ssIsSpecialSampleHit("1")) {
        /* In general, processing on DWork[0:10] can be done
           here, but it does cause the faster rate to have
           nonuniform processing requirements (every 10th hit,
           more code needs to be run).*/
        DWork[10] = sum(DWork[0:9])/10;
        DWork[mycounter] = 0;
    }
}
if (ssIsSampleHit("1")) {
    /* Processing on DWork[10] can be done here before
       outputting. This code runs on every hit of the
```

```
        slower task. */  
    y = DWork[10];  
}
```

**Rules for Properly Handling Slow-to-Fast Transitions.** When output rates are faster than input rates, input should only be read at the rate that is associated with the input port sample time, observing the following rules:

- Always read input from the update function.
- Use no special sample hit checks when reading input.
- Write the input to a DWork.
- When there is a special sample hit between the rates, copy the DWork into a second DWork in the output function.
- Write the second DWork to the output at every hit of the output sample rate.

The block can request that the input port be made local but it cannot be set to reusable. The output port can be set to local and reusable.

As in the fast-to-slow transition case, the input should not be read by any rate other than the one assigned to the input port. Similarly, the output should not be written to at any rate other than the rate assigned to the output port.

An optimization can be made when the algorithm being implemented is only required to run at the slow rate. In such cases, you use only one DWork. The input still writes to the DWork in the update function. When there is a special sample hit between the rates, the output function copies the same DWork directly to the output. You must set the output port to be global and not reusable in this case. This optimization results in one less memcopy operation per special sample hit.

In either case, the data that the fast rate computations operate on is always delayed, that is, the data is from the previous step of the slow rate code.

**Pseudocode Examples of Slow-to-Fast Rate Transition.** The pseudocode below abstracts what your S-function needs to do to handle slow-to-fast transitions, illustrating with an input rate of one second driving an output rate of 0.1 second. The block has following characteristics:

- File: `sfun_multirate_delay.c`, Equation:  $y = u(\text{tslow}-1)$
- Input: Set to local, will be local if output/update are combined (ERT) otherwise will be global. Set to not reusable because input needs to be preserved until the update function runs.
- Output: local and reusable
- DirectFeedthrough: no

```

OutputFcn
if (ssIsSampleHit(".1")) {
    if (ssIsSpecialSampleHit("1")) {
        DWork[1] = DWork[0];
    }
    y = DWork[1];
}
UpdateFcn
if (ssIsSampleHit("1")) {
    DWork[0] = u;
}

```

An alternative, optimized approach can be used by some algorithms:

- Input: Set to local, will be local if output/update are combined (ERT) otherwise will be global. Set to not reusable because input needs to be preserved until the update function runs.
- Output: global and not reusable because it needs to persist between special sample hits.
- DirectFeedthrough: no

```

OutputFcn
if (ssIsSampleHit(".1")) {
    if (ssIsSpecialSampleHit("1")) {
        y = DWork;
    }
}
UpdateFcn
if (ssIsSampleHit("1")) {
    DWork = u;
}

```

Example adding a simple algorithm:

- File: `sfun_multirate_modulate.c`, Equation:  $y = \sin(\text{tfast}) + u(\text{tslow}-1)$
- Input: Set to local, will be local if output/update are combined (an ERT feature) otherwise will be global. Set to not reusable because input needs to be preserved until the update function runs.
- Output: local and reusable
- DirectFeedthrough: no

OutputFcn

```
if (ssIsSampleHit(".1")) {
    if (ssIsSpecialSampleHit("1")) {
        /* Processing not likely to be done here. It causes
        * the faster rate to have nonuniform processing
        * requirements (every 10th hit, more code needs to
        * be run).*/
        DWork[1] = DWork[0];
    }
    /* Processing done at fast rate */
    y = sin(ssGetTaskTime(".1")) + DWork[1];
}
```

UpdateFcn

```
if (ssIsSampleHit("1")) {
    /* Processing on 'u' can be done here. There is a delay of
    one slow rate period before the fast rate sees it.*/
    DWork[0] = u;}
}
```

## Build Support for S-Functions

- “About Build Support for S-Functions” on page 14-121
- “Implicit Build Support” on page 14-121
- “Specify Additional Source Files for an S-Function” on page 14-122
- “Use TLC Library Functions” on page 14-123
- “Use `rtwmakecfg.m` API to Customize Generated Makefiles” on page 14-124



- “Precompile S-Function Libraries” on page 14-129

## About Build Support for S-Functions

User-written S-Function blocks provide a powerful way to incorporate legacy and custom code into the Simulink and Simulink Coder development environment. In most cases, you should use S-functions to integrate existing code with Simulink Coder generated code. Several approaches to writing S-functions are available as discussed in

- “Write Noninlined S-Functions” on page 14-52
- “Write Wrapper S-Functions” on page 14-54
- “Write Fully Inlined S-Functions” on page 14-64
- “Write Fully Inlined S-Functions with mdlRTW Routine” on page 14-65
- “S-Functions That Support Code Reuse” on page 14-113
- “S-Functions for Multirate Multitasking Environments” on page 14-113

S-functions also provide the most flexible and capable way of including build information for legacy and custom code files in the Simulink Coder build process.

This section discusses the different ways of adding S-functions to the Simulink Coder build process.

## Implicit Build Support

When building models with S-functions, the code generator automatically adds rules, include paths, and source filenames to the generated makefile. For this to occur, the source files (.h, .c, and .cpp) for the S-function must be in the same folder as the S-function MEX-file. The code generator propagates this information through the token expansion mechanism of converting a template makefile (TMF) to a makefile. The propagation requires the TMF to support the tokens.

Details of the implicit build support follow:

- If the file *sfcname.h* exists in the same folder as the S-function MEX-file (for example, *sfcname.mexext*), the folder is added to the include path.

- If the file `sfcname.c` or `sfcname.cpp` exists in the same folder as the S-function MEX-file, the Simulink Coder code generator adds a makefile rule for compiling files from that folder.
- When an S-function is not inlined with a TLC file, the Simulink Coder code generator must compile the S-function's source file. To determine the name of the source file to add to the list of files to compile, the code generator searches for `sfcname.cpp` on the MATLAB path. If the source file is found, the code generator adds the source filename to the makefile. If `sfcname.cpp` is not found on the path, the code generator adds the filename `sfcname.c` to the makefile, whether or not it is on the MATLAB path.

---

**Note** For the Simulink engine to find the MEX-file for simulation and code generation, it must exist on the MATLAB path or be in your current MATLAB working folder.

---

### Specify Additional Source Files for an S-Function

If your S-function has additional source file dependencies, you must add the names of the additional modules to the build process. You can do this by specifying the filenames

- In the **S-function modules** field of the S-Function block parameter dialog box
- With the `SFunctionModules` parameter in a call to the `set_param` function

For example, suppose you build your S-function with multiple modules, as in

```
mex sfun_main.c sfun_module1.c sfun_module2.c
```

You can then add the modules to the build process by doing one of the following:

- Specifying `sfun_main`, `sfun_module1`, and `sfun_module2` in the **S-function modules** field in the S-Function block dialog box
- Entering the following command at the MATLAB command prompt:

```
set_param(sfun_block, 'SFunctionModules', 'sfun_module1 sfun_module2')
```

Alternatively, you can define a variable to represent the parameter value.

```
modules = 'sfun_module1 sfun_module2'  
set_param(sfun_block, 'SFunctionModules', modules)
```

---

**Note** The **S-function modules** field and `SFunctionModules` parameter do not support complete source file path specifications. To use the parameter, the Simulink Coder software must be able to find the additional source files when executing the makefile. For the Simulink Coder software to locate the additional files, place them in the same folder as the S-function MEX-file. This will enable you to leverage the implicit build support discussed in “Implicit Build Support” on page 14-121.

---

For more complicated S-function file dependencies, such as specifying source files in other locations or specifying libraries or object files, use the `rtwmakecfg.m` API, as explained in “Use `rtwmakecfg.m` API to Customize Generated Makefiles” on page 14-124.

## Use TLC Library Functions

If you inline your S-function by writing a TLC file, you can add source filenames to the build process by using the TLC library function `LibAddToModelSources`. For details, see “`LibAddSourceFileCustomSection` (file, builtInSection, newSection)” in the Target Language Compiler documentation.

---

**Note** This function does not support complete source file path specifications and assumes the Simulink Coder software can find the additional source files when executing the makefile.

---

Another useful TLC library function is `LibAddToCommonIncludes`. Use this function in a `#include` statement to include S-function header files in the generated `model.h` header file. For details, see

“LibAddToCommonIncludes(incFileName)” in the Target Language Compiler documentation.

For more complicated S-function file dependencies, such as specifying source files in other locations or specifying libraries or object files, use the `rtwmakecfg.m` API, as explained in “Use `rtwmakecfg.m` API to Customize Generated Makefiles” on page 14-124.

### Use `rtwmakecfg.m` API to Customize Generated Makefiles

- “Overview” on page 14-124
- “Create the `rtwmakecfg` Function” on page 14-125
- “Modify the Template Makefile” on page 14-127

**Overview.** Simulink Coder TMFs provide tokens that let you add the following items to generated makefiles:

- Source folders
- Include folders
- Run-time library names
- Run-time module objects

S-functions can add this information to the makefile by using an `rtwmakecfg` function. This function is particularly useful when building a model that contains one or more of your S-Function blocks, such as device driver blocks.

To add information pertaining to an S-function to the makefile,

- 1** Create the MATLAB language function `rtwmakecfg` in a file `rtwmakecfg.m`. The Simulink Coder software associates this file with your S-function based on its folder location. “Create the `rtwmakecfg` Function” on page 14-125 discusses the requirements for the `rtwmakecfg` function and the data it should return.
- 2** Modify your target’s TMF such that it supports macro expansion for the information returned by `rtwmakecfg` functions. “Modify the Template Makefile” on page 14-127 discusses the required modifications.

After the TLC phase of the build process, when generating a makefile from the TMF, the Simulink Coder code generator searches for an `rtwmakecfg.m` file in the folder that contains the S-function component. If it finds the file, the code generator calls the `rtwmakecfg` function.

**Create the `rtwmakecfg` Function.** Create the `rtwmakecfg.m` file containing the `rtwmakecfg` function in the same folder as your S-function component (`sfcname.mexext` on a Microsoft Windows system and `sfcname` and a platform-specific extension on The Open Group UNIX system). The function must return a structured array that contains the following fields:

Field	Description
<code>makeInfo.includePath</code>	A cell array that specifies additional include folder names, organized as a row vector. The Simulink Coder code generator expands the folder names into include instructions in the generated makefile.
<code>makeInfo.sourcePath</code>	A cell array that specifies additional source folder names, organized as a row vector. You must include the folder names of files entered into the <b>S-function modules</b> field on the S-Function Block Parameters dialog box or into the block's <code>SFunctionModules</code> parameter if they are not in the same folder as the S-function. The Simulink Coder code generator expands the folder names into make rules in the generated makefile.
<code>makeInfo.sources</code>	A cell array that specifies additional source filenames (C or C++), organized as a row vector. Do not include the name of the S-function or any files entered into the <b>S-function modules</b> field on the S-Function Block Parameters dialog box or into the block's <code>SFunctionModules</code> parameter. The Simulink Coder code generator expands the filenames into make variables that contain the source files. You should specify only filenames (with extension). Specify path information with the <code>sourcePath</code> field.

Field	Description
<code>makeInfo.linkLibsObjs</code>	A cell array that specifies additional, fully qualified paths to object or library files against which the Simulink Coder generated code should link. The Simulink Coder code generator does not compile the specified objects and libraries. However, it includes them when linking the final executable. This can be useful for incorporating libraries that you do not want the Simulink Coder code generator to recompile or for which the source files are not available. You might also use this element to incorporate source files from languages other than C and C++. This is possible if you first create a C compatible object file or library outside of the Simulink Coder build process.
<code>makeInfo.precompile</code>	A Boolean flag that indicates whether the libraries specified in the <code>rtwmakecfg.m</code> file exist in a specified location ( <code>precompile==1</code> ) or if the libraries need to be created in the build folder during the Simulink Coder build process ( <code>precompile==0</code> ).
<code>makeInfo.library</code>	A structure array that specifies additional run-time libraries and module objects, organized as a row vector. The Simulink Coder code generator expands the information into make rules in the generated makefile. See the next table for a list of the library fields.

The `makeInfo.library` field consists of the following elements:

Element	Description
<code>makeInfo.library(n).Name</code>	A character array that specifies the name of the library (without an extension).
<code>makeInfo.library(n).Location</code>	A character array that specifies the folder in which the library is located when precompiled. See the description of <code>makeInfo.precompile</code> in the preceding table for more information. A target can use the <code>TargetPreCompLibLocation</code> parameter to override

Element	Description
	this value. See “Specify the Location of Precompiled Libraries” on page 22-8 for details.
makeInfo.library(n).Modules	A cell array that specifies the C or C++ source file base names (without an extension) that comprise the library. Do not include the file extension. The makefile appends the object extension.

---

**Note** The `makeInfo.library` field must fully specify each library and how to build it. The modules list in the `makeInfo.library(n).Modules` element cannot be empty. If you need to specify a link-only library, use the `makeInfo.linkLibsObjs` field instead.

---

### Example:

```
disp(['Running rtwmakecfg from folder: ',pwd]);
makeInfo.includePath = { fullfile(pwd, 'somedir2') };
makeInfo.sourcePath = {fullfile(pwd, 'somedir2'), fullfile(pwd, 'somedir3')};
makeInfo.sources = { 'src1.c', 'src2.cpp'};
makeInfo.linkLibsObjs = { fullfile(pwd, 'somedir3', 'src3.object'),...
                        fullfile(pwd, 'somedir4', 'mylib.library')};
makeInfo.precompile = 1;
makeInfo.library(1).Name = 'myprecompiledlib';
makeInfo.library(1).Location = fullfile(pwd, 'somedir2', 'lib');
makeInfo.library(1).Modules = {'srcfile1' 'srcfile2' 'srcfile3' };
```

---

**Note** If a path that you specify in the `rtwmakecfg.m` API contains spaces, the code generator does not automatically convert the path to its non-space equivalent. If the build environments you intend to support do not support spaces in paths, refer to “Enabling the Simulink® Coder™ Software to Build When Path Names Contain Spaces” on page 9-44.

---

**Modify the Template Makefile.** To expand the information generated by an `rtwmakecfg` function, you can modify the following sections of your target’s TMF:

- Include Path
- C Flags and/or Additional Libraries
- Rules

The TMF code examples below may not apply to your make utility. For additional examples, see the GRT or ERT TMFs located in *matlabroot/rtw/c/grt/\*.tmf* or *matlabroot/rtw/c/ert/\*.tmf*.

### Add Folder Names to the Makefile Include Path

The following TMF code example adds folder names to the include path in the generated makefile:

```
ADD_INCLUDES = \  
|>START_EXPAND_INCLUDES<|    -I|>EXPAND_DIR_NAME<| \  
|>END_EXPAND_INCLUDES<|
```

Additionally, the `ADD_INCLUDES` macro must be added to the `INCLUDES` line, as shown below.

```
INCLUDES = -I. -I.. $(MATLAB_INCLUDES) $(ADD_INCLUDES) $(USER_INCLUDES)
```

### Add Library Names to the Makefile

The following TMF code example adds library names to the generated makefile.

```
LIBS = \  
|>START_PRECOMP_LIBRARIES<| \  
LIBS += |>EXPAND_LIBRARY_NAME<|.a |>END_PRECOMP_LIBRARIES<| \  
|>START_EXPAND_LIBRARIES<| \  
LIBS += |>EXPAND_LIBRARY_NAME<|.a |>END_EXPAND_LIBRARIES<|
```

For more information on how to use configuration parameters to control library names and location during the build process, see “Control Library Location and Naming During Build” on page 22-7.



## Add Rules to the Makefile

The following TMF code example adds rules to the generated makefile.

```
|>START_EXPAND_RULES<|
$(BLD)/%.o: |>EXPAND_DIR_NAME<|/%.c $(SRC)/$(MAKEFILE) rtw_proj.tmw
    @$ (BLANK)
    @echo ### "|>EXPAND_DIR_NAME<|\$.c"
    $(CC) $(CFLAGS) $(APP_CFLAGS) -o $(BLD)$(DIRCHAR)$*.o \
    |>EXPAND_DIR_NAME<|$(DIRCHAR)$*.c > $(BLD)$(DIRCHAR)$*.lst
|>END_EXPAND_RULES<|

|>START_EXPAND_LIBRARIES<|MODULES_|>EXPAND_LIBRARY_NAME<| = \
|>START_EXPAND_MODULES<|    |>EXPAND_MODULE_NAME<|.o \
|>END_EXPAND_MODULES<|

|>EXPAND_LIBRARY_NAME<|.a : $(MAKEFILE) rtw_proj.tmw
$(MODULES_|>EXPAND_LIBRARY_NAME<|:%.o=$(BLD)/%.o)
    @$ (BLANK)
    @echo ### Creating $@
    $(AR) -r $@ $(MODULES_|>EXPAND_LIBRARY_NAME<|:%.o=$(BLD)/%.o)
|>END_EXPAND_LIBRARIES<|

|>START_PRECOMP_LIBRARIES<|MODULES_|>EXPAND_LIBRARY_NAME<| = \
|>START_EXPAND_MODULES<|    |>EXPAND_MODULE_NAME<|.o \
|>END_EXPAND_MODULES<|

|>EXPAND_LIBRARY_NAME<|.a : $(MAKEFILE) rtw_proj.tmw
$(MODULES_|>EXPAND_LIBRARY_NAME<|:%.o=$(BLD)/%.o)
    @$ (BLANK)
    @echo ### Creating $@
    $(AR) -r $@ $(MODULES_|>EXPAND_LIBRARY_NAME<|:%.o=$(BLD)/%.o)
|>END_PRECOMP_LIBRARIES<|
```

## Precompile S-Function Libraries

You can precompile new or updated S-function libraries (MEX-files) for a model by using the MATLAB language function `rtw_precompile_libs`. Using a specified model and a library build specification, this function builds and places the libraries in a precompiled library folder.

By precompiling S-function libraries, you can optimize system builds. Once your precompiled libraries exist, the Simulink Coder code generator can omit library compilation from subsequent builds. For models that use numerous libraries, the time savings for build processing can be significant.

To use `rtw_precompile_libs`,

- 1** Set the library file suffix, including the file type extension, based on the platform in use.
- 2** Set the precompiled library folder.
- 3** Define a build specification.
- 4** Issue a call to `rtw_precompile_libs`.

The following procedure explains these steps in more detail.

- 1** Set the library file suffix, including the file type extension, based on the platform in use.

Consider checking for the type of platform in use and then using the `TargetLibSuffix` parameter to set the library suffix accordingly. For example, you might set the suffix to `.a` for a UNIX platform and `_vc.lib` otherwise.

```
if isunix
    suffix = '.a';
else
    suffix = '_vc.lib';
end

set_param(my_model, 'TargetLibSuffix', suffix);
```

- 2** Set the precompiled library folder.

Use one of the following methods to set the precompiled library folder.

- Set the `TargetPreCompLibLocation` parameter, as explained in “Specify the Location of Precompiled Libraries” on page 22-8.
- Set the `makeInfo.precompile` field in an `rtwmakecfg.m` function file.

If you set both `TargetPreCompLibLocation` and `makeInfo.precompile`, the setting for `TargetPreCompLibLocation` takes precedence.

The following command sets the precompiled library folder for model `my_model` to folder `lib` under the current working folder.

```
set_param(my_model,'TargetPreCompLibLocation', fullfile(pwd,'lib'));
```

---

**Note** If you set both the target folder for the precompiled library files and a target library file suffix, the Simulink Coder code generator automatically detects whether any precompiled library files are missing while processing builds.

---

### 3 Define a build specification.

Set up a structure that defines a build specification. The following table describes fields you can define in the structure. All fields except `rtwmakecfgDirs` are optional.

Field	Description
<code>rtwmakecfgDirs</code>	A cell array of strings that name the folders containing <code>rtwmakecfg</code> files for libraries to be precompiled. The function uses the <code>Name</code> and <code>Location</code> elements of <code>makeInfo.library</code> , as returned by <code>rtwmakecfg</code> , to specify the name and location of the precompiled libraries. If you set the <code>TargetPreCompLibLocation</code> parameter to specify the library folder, that setting overrides the <code>makeInfo.library.Location</code> setting. <b>Note:</b> The specified model must contain blocks that use precompiled libraries specified by the <code>rtwmakecfg</code> files because the TMF-to-makefile conversion generates the library rules only if the libraries are used.
<code>libSuffix</code>	A string that specifies the suffix, including the file type extension, to be appended to the name of each library (for example, <code>.a</code> or <code>_vc.lib</code> ). The string must include a period ( <code>.</code> ). You must set the suffix with either this field or the <code>TargetLibSuffix</code> parameter. If you specify a suffix with both mechanisms, the <code>TargetLibSuffix</code> setting overrides the setting of this field.

Field	Description
<code>intOnlyBuild</code>	A Boolean flag. When set to true, the flag indicates the libraries are to be optimized such that they are compiled from integer code only. This field applies to ERT targets only.
<code>makeOpts</code>	A string that specifies an option to be included in the <code>rtwMake</code> command line.
<code>addLibs</code>	<p>A cell array of structures that specify libraries to be built that are not specified by an <code>rtwmakecfg</code> function. Each structure must be defined with two fields that are character arrays:</p> <ul style="list-style-type: none"> <li>• <code>libName</code> — the name of the library without a suffix</li> <li>• <code>libLoc</code> — the location for the precompiled library</li> </ul> <p>The TMF can specify other libraries and how those libraries are to be built. Use this field if you need to precompile those libraries.</p>

The following commands set up build specification `build_spec`, which indicates that the files to be compiled are in folder `src` under the current working folder.

```
build_spec = [];
build_spec.rtwmakecfgDirs = {fullfile(pwd,'src')};
```

#### 4 Issue a call to `rtw_precompile_libs`.

Issue a call to `rtw_precompile_libs` that specifies the model for which you want to build the precompiled libraries and the build specification. For example:

```
rtw_precompile_libs(my_model,build_spec);
```

# Program Building, Interaction, and Debugging

---

- “Compiler or IDE Selection and Configuration” on page 15-2
- “Program Builds” on page 15-12
- “Build and Run a Program” on page 15-43
- “Profile Code Performance” on page 15-45
- “Data Exchange” on page 15-50

## Compiler or IDE Selection and Configuration

In this section...
“Choose and Configure a Compiler” on page 15-2
“Troubleshoot Compiler Configurations” on page 15-9

### Choose and Configure a Compiler

- “Compilers and the Build Process” on page 15-2
- “Simulink® Coder™ and ANSI C/C++ Compliance” on page 15-3
- “Support for C and C++ Code Generation” on page 15-4
- “Support for International (Non-US-ASCII) Characters” on page 15-5
- “C++ Target Language Considerations” on page 15-7
- “Choose and Configure Compiler on Microsoft Windows” on page 15-8
- “Choose and Configure Compiler on UNIX” on page 15-9
- “Include S-Function Source Code” on page 15-9

### Compilers and the Build Process

The Simulink Coder build process depends upon the installation of one or more supported compilers. *Compiler*, in this context, refers to a development environment containing a linker and make utility, in addition to a high-level language compiler. For details on supported compiler versions, see

[http://www.mathworks.com/support/compilers/current\\_release](http://www.mathworks.com/support/compilers/current_release)

Most Simulink Coder targets create an executable that runs on your workstation. When creating the executable, the Simulink Coder build process must be able to access a supported compiler. The build process can automatically find a compiler to use based on your default MEX compiler.

The build process also requires the selection of a template makefile. The template makefile determines which compiler runs, during the make phase of the build, to compile the generated code.

To determine which template makefiles are for your compiler and target, see [Targets Available from the System Target File Browser](#) on page 9-12.

For both Simulink Coder generated files and user-supplied files, the file extension, `.c` or `.cpp`, determines whether a C or a C++ compiler will be used in the Simulink Coder build process. If the file extension is `.c`, a C compiler will be used to compile the file, and the symbols will use the C linkage convention. If the file extension is `.cpp`, a C++ compiler will be used to compile the file, and the symbols by default will use the C++ linkage specification.

### Simulink Coder and ANSI C/C++ Compliance

The Simulink Coder software generates code that is compliant with the following standards:

Language	Supported Standard
C	ISO/IEC 9899:1990, also known as C89/C90
C++	ISO/IEC 14882:2003

Code generated by the Simulink Coder software from the following sources is ANSI C/C++ compliant:

- Simulink built-in block algorithmic code
- Simulink Coder and Embedded Coder system level code (task ID [TID] checks, management, functions, and so on)
- Code from other blocksets, including the Simulink Fixed Point product, the Communications System Toolbox product, and so on
- Code from other code generators, such as MATLAB functions

Additionally, the Simulink Coder software can incorporate code from

- Embedded targets (for example, startup code, device driver blocks)
- User-written S-functions or TLC files

---

**Note** Coding standards for these two sources are beyond the control of the Simulink Coder software, and can be a source for compliance problems, such as code that uses C99 features not supported in the ANSI C, C89/C90 subset.

---

### **Support for C and C++ Code Generation**

Simulink Coder supports C and C++ code generation. Consider the following as you choose a language for your generated code:

- Whether you need to configure Simulink Coder to use a specific compiler. This is required to generate C++ code on Windows. See “Choose and Configure a Compiler” on page 15-2.
- The language configuration setting for the model. See “Select the Target Language” on page 9-71.
- Whether you need to integrate legacy or custom code with generated code. For a summary of integration options, see “Integration Options” on page 14-2.
- Whether you need to integrate C and C++ code. If so, see “Integration Options” on page 14-2.

---

**Note** You can mix C and C++ code when integrating Simulink Coder generated code with custom code. However, you must be aware of the differences between C and default C++ linkage conventions, and add the `extern "C"` linkage specifier where required. For the details of the differing linkage conventions and how to apply `extern "C"`, refer to a C++ programming language reference book.

---

- “C++ Target Language Limitations” on page 15-4.

For an example, enter `sfcndemo_cppcount` in the MATLAB Command Window. For a Stateflow example, enter `sf_cpp`.

### **C++ Target Language Limitations.**

- Simulink Coder does not support C++ code generation for the following:



SimDriveline  
SimMechanics  
SimPowerSystems  
Embedded Targets in Embedded Coder  
Desktop Targets in Simulink Coder  
xPC Target

- The following Embedded Coder dialog box fields currently do not accept the .cpp extension. However, a .cpp file will be generated if you specify a filename without an extension in these fields, with C++ selected as the target language for your generated code.
    - **Data definition filename** field on the **Data Placement** pane of the Configuration Parameters dialog box
    - **Definition file** field for an **mpt data object** in the Model Explorer
- These restrictions on specifying .cpp will be removed in a future release.

## Support for International (Non-US-ASCII) Characters

Simulink Coder does not include non-US-ASCII characters in compilable portions of source code. However, Simulink, Stateflow, Simulink Coder, and Embedded Coder do support non-US-ASCII characters in certain ways. When non-US-ASCII characters are encountered during code generation, they either become comments in the generated code or do not propagate into the generated source files. Sources of non-US-ASCII characters are described below:

- **Simulink Block Names:** The name of Simulink blocks are permitted to use non-US-ASCII character sets. The block name can be output in a comment above the generated code for that block when the **Simulink block / Stateflow object comments** check box is selected. If Simulink Coder also uses the block name in the generated code as an identifier, the identifier's name changes so only US-ASCII characters are present.

One exception to using non-US-ASCII characters in block names is for nonvirtual subsystems configured to use the subsystem name as either the function name or the filename. In this case, only US-ASCII characters can be used to name the subsystem.
- **User comments on Stateflow diagrams:** These comments can contain non-US-ASCII characters. They are written to the generated code when the **Include comments** check box is selected.

- Custom TLC files (.t1c): User-created Target Language Compiler files can have non-US-ASCII characters inside both TLC comments and in any code comments which are output. The Target Language Compiler does not support non-US-ASCII characters in TLC variable or function names.

**Additional Support with Embedded Coder.** Users of Embedded Coder have additional international character support:

- Simulink Block Description: Embedded Coder propagates block descriptions entered from Simulink Block Parameter dialog boxes into the generated code as comments when the **Simulink block descriptions** check box on the **Code Generation > Comments** pane of the Configuration Parameters dialog box is selected. Non-US-ASCII characters are supported for these descriptions.
- Embedded Coder code template file: Code Generation Template (.cgt) files provide customization capability for the generated code. Any output lines in the .cgt file which are C or C++ comments can contain non-US-ASCII characters, for example the file banner and file trailer sections; these comments are propagated to the generated code. However, although TLC comments in .cgt files can contain non-US-ASCII characters, these TLC comments are not propagated to the generated code.
- Stateflow object descriptions: Stateflow object descriptions can contain non-US-ASCII characters. The description will appear as a comment above the generated code for that chart when the **Stateflow object descriptions** check box is selected.
- Simulink Parameter Object Description: Simulink Parameter Object descriptions can contain non-US-ASCII characters. The description will appear as a comment above the generated code when the Simulink data object descriptions check box is selected.
- MPT Signal Object Description: MPT object descriptions can contain non-US-ASCII characters. The description will appear as a comment above the generated code when the Simulink data object descriptions check box is selected.

**Character Set Limitation.** You can encounter problems with models containing characters of a specific character set, such as Shift JIS, on a host system for which that character set is not configured as the default.

When models containing characters of a given character set are used on a host system that is not configured with that character set as the default, Simulink can incorrectly interpret characters during model loading and saving. This can lead to corrupted characters being displayed in the model and possibly the model failing to load. It can also lead to corrupted characters in the model file if you save it.

This limitation does not exist when the characters used in the model are in the default character set for the host system. For example, you can use Shift JIS characters with no issues if the host system is configured to use Japanese Windows.

Additionally, during code generation, the Target Language Compiler can have similar problems reading characters from either the *model.rtw* or user written *.tlc* files. This can result in corrupt characters in generated source file comments or a Target Language Compiler error.

For an example of international character set support for code generation, run the example model *rtwdemo\_international*. This example model is set up to work around the character limitations described above. If you run this example from a non-Japanese MATLAB host machine, you must set up an international character set for Simulink. For example, type

```
bdclose all; set_param(0, 'CharacterEncoding', 'Shift_JIS')
rtwdemo_international
```

Other uses of non-US-ASCII characters in models or in files used during the build process are not supported; you should not depend on any incidental functionality that may exist.

For additional information, see the `slCharacterEncoding` function.

## **C++ Target Language Considerations**

To use the C++ target language support, you might need to configure the Simulink Coder software to use a specific compiler. For example, on a Microsoft Windows platform the default compiler is the Lcc C compiler shipped with the MATLAB product, which does not support C++. If you do not configure the Simulink Coder software to use a C++ compiler before you specify C++ for code generation, the following build error message appears:

The specified target is configured to generate C++, but the C-only compiler, LCC, is the default compiler. To specify a C++ compiler, enter 'mex -setup' at the command prompt. To generate C code, click (Open) to open the Configuration Parameters dialog and set the target language to C.

### **Choose and Configure Compiler on Microsoft Windows**

On Windows platforms, you can use the Lcc C compiler shipped with the MATLAB product, or you can install and use one of the supported Windows compilers.

The Simulink Coder code generator will choose a compiler based on the template makefile (TMF) name specified on the **Code Generation** pane of the Configuration Parameters dialog box. The simplest approach is to let the code generator pick a compiler based on your default compiler, as set up using the `mex -setup` function. When you use this approach, you do not need to define compiler-specific environment variables, and the Simulink Coder code generator determines the location of the compiler using information from the `mexopts.bat` file located in the preferences folder (use the `prefdir` command to verify this location).

To use this approach, the TMF filename specified must be a MATLAB language file that returns default compiler information by using the `mexopts.bat` file. Most targets provided by the Simulink Coder product use this approach, as when `grt_default_tmf` or `ert_default_tmf` is specified as the TMF name.

Alternatively, the name provided for the TMF can be a compiler-specific template makefile, for example `grt_vc.tmf`, which designates the Microsoft Visual C++ compiler. When you provide a compiler-specific TMF filename, the Simulink Coder code generator uses the default `mexopts.bat` information to locate the compiler if `mex` has been set up for the same compiler as the specified TMF. If `mex` is not set up with a default compiler, or if it does not match the compiler specified by the TMF, then an environment variable must exist for the compiler specified by the TMF. The environment variable required depends on the compiler.

## Choose and Configure Compiler on UNIX

On a UNIX platform, the Simulink Coder build process uses the default compiler. The default compiler is `cc`.

You should choose the UNIX template makefile for your target. For example, `grt_unix.tmf` is the template makefile for building a generic real-time program on a UNIX platform.

## Include S-Function Source Code

When the Simulink Coder code generator builds models with S-functions, source code for the S-functions can be either in the current folder or in the same folder as their MEX-file. The code generator adds an include path to the generated makefiles whenever it finds a file named `sfcnname.h` in the same folder that the S-function MEX-file is in. This folder must be on the MATLAB path.

Similarly, the Simulink Coder code generator adds a rule for the folder when it finds a file `sfcnname.c` (or `.cpp`) in the same folder as the S-function MEX-file is in.

## Troubleshoot Compiler Configurations

- “Compiler Version Mismatch Errors” on page 15-9
- “Generated Executable Image Produces Incorrect Results” on page 15-10
- “Compile-Time Errors” on page 15-10

## Compiler Version Mismatch Errors

**Explanation.** You received a version mismatch error when you compiled code generated by the Simulink Coder software.

### User Action.

- 1 Check the list of currently supported and compatible compilers available at [http://www.mathworks.com/support/compilers/current\\_release/](http://www.mathworks.com/support/compilers/current_release/).

- 2 If necessary, upgrade or change your compiler. For more information, see “Choose and Configure a Compiler” on page 15-2.
- 3 Rebuild the model.

## Generated Executable Image Produces Incorrect Results

**Explanation.** You applied compiler optimizations when you used Simulink Coder to generate an executable image. However, the optimizations caused the executable image to produce incorrect results, even though expected code was generated.

**User Action.** Do one of the following:

- Lower the compiler optimization level.
  - 1 Select Custom for the Model Configuration parameter **Code Generation > Compiler optimization level**. The **Custom compiler optimization flags** field appears.
  - 2 Specify a lower optimization level in the **Custom compiler optimization flags** field.
  - 3 Rebuild the model.
- Disable compiler optimizations.
  - 1 Select **Optimizations off (faster builds)** for the Model Configuration parameter **Code Generation > Compiler optimization level**.
  - 2 Rebuild the model.

For more information, see “Control Compiler Optimizations” on page 16-6 and your compiler documentation.

## Compile-Time Errors

### Explanations.

- You received a compiler configuration error.

- Environment variables for your make utility, compiler, or linker are set up incorrectly. For example, installation of Cygwin tools on a Windows platform might affect environment variables used by other compilers.
- Custom code specified as an S-function block or in the **Code Generation > Custom Code** pane of the Configuration Parameters dialog includes errors. For example, the code might refer to a header file that the compiler cannot find.
- The model includes a block, such as a device driver block, that is not intended for use with the currently selected target.

### User Actions.

- Make sure that MATLAB supports the compiler and version that you want to use. For a list of currently supported and compatible compilers, see [http://www.mathworks.com/support/compilers/current\\_release/](http://www.mathworks.com/support/compilers/current_release/). If necessary, upgrade or change your compiler (see “Choose and Configure a Compiler” on page 15-2).
- Review the environment variable settings for your system by using the `set` command on a Windows platform or `setenv` on a UNIX platform. Make sure the settings match what is required for the tools you are using.
- Remove the custom code from the model, to help isolate the source of the problem, debug, and rebuild.
- Remove the target-specific block or configure the model for use with the another target.

## Program Builds

### In this section...

- “Configure the Build Process” on page 15-12
- “Initiate the Build Process” on page 15-14
- “Build a Generic Real-Time Program” on page 15-14
- “Rebuild a Model” on page 15-27
- “Control Regeneration of Top Model Code” on page 15-27
- “Reduce Build Time for Referenced Models” on page 15-28
- “Relocate Code to Another Development Environment” on page 15-33
- “How Executable Programs Are Built From Models” on page 15-38

### Configure the Build Process

- “Specify TLC Options” on page 15-12
- “Specify Whether To Generate a Makefile” on page 15-13
- “Specify a Make Command” on page 15-13
- “Specify the Template Makefile” on page 15-13

### Specify TLC Options

You can enter Target Language Compiler (TLC) command line options in the **TLC options** edit field, for example

- -aVarName=1 to declare a TLC variable and/or assign a value to it
- -IC:\Work to specify an include path
- -v to obtain verbose output from TLC processing (for example, when debugging)

Specifying TLC options does not add any flags to the **Make command** field, as do some of the targets available in the System Target File Browser.

For additional information, see “Target Language Compiler Overview”.



## Specify Whether To Generate a Makefile

The **Generate makefile** option specifies whether the Simulink Coder build process is to generate a makefile for a model. By default, the Simulink Coder build process generates a makefile. You can suppress the generation of a makefile, for example in support of custom build processing that is not based on makefiles, by clearing **Generate makefile** . When you clear this option,

- The **Make command** and **Template makefile** options are unavailable.
- You must set up any post code generation build processing, using a user-defined command, as explained in “Customize Post-Code-Generation Build Processing” on page 22-13.

## Specify a Make Command

A high-level MATLAB command, invoked when a build is initiated, controls the Simulink Coder build process. Each target has an associated **make** command. The **Make command** field displays this command.

Almost all targets use the default command, `make_rtw`. Third-party targets might supply another **make** command. See the vendor’s documentation.

In addition to the name of the **make** command, you can supply arguments in the **Make command** field. These arguments include compiler-specific options, include paths, and other parameters. When the build process invokes the **make** utility, these arguments are passed along in the **make** command line.

“Template Makefiles and Make Options” on page 9-38 lists the **Make command** arguments you can use with each supported compiler.

## Specify the Template Makefile

The **Template makefile** field has these functions:

- If you have selected a target configuration using the System Target File Browser, this field displays the name of a MATLAB language file that selects a template makefile for your development environment. For example, in “Code Generation Pane: General”, the **Template makefile** field displays `grt_default_tmf`, indicating that the build process invokes `grt_default_tmf.m`.

“Template Makefiles and Make Options” on page 9-38 gives a detailed description of the logic by which the Simulink Coder build process selects a template makefile.

- Alternatively, you can explicitly enter the name of a specific template makefile (including the extension) or a MATLAB language file that returns a template make file in this field. You must do this if you are using a target configuration that does not appear in the System Target File Browser. For example, do this if you have written your own template makefile for a custom target environment or you.

If you specify your own template makefile, be sure to include the filename extension. If you omit the extension, the Simulink Coder build process attempts to find and execute a file with the extension `.m` (that is, a MATLAB language file). The template make file (or a MATLAB language file that returns a template make file) must be on the MATLAB path. To determine whether the file is on the MATLAB path, enter the following command in the MATLAB Command Window:

```
which tmf_filename
```

## Initiate the Build Process

You can initiate code generation and the build process by using the following options:

- Clear the **Generate code only** option on the **Code Generation** pane of the Configuration Parameters dialog box and click **Build**.
- Press **Ctrl+B**.
- Select **Code > C/C++ Code > Build Model**.
- Invoke the `rtwbuild` command from the MATLAB command line.
- Invoke the `slbuild` command from the MATLAB command line.

## Build a Generic Real-Time Program

- “About Building a Program” on page 15-15
- “Working and Build Folders” on page 15-15
- “Set Program Parameters” on page 15-16

- “Select a Target Configuration” on page 15-18
- “Build and Run a Program” on page 15-23
- “Contents of the Build Folder” on page 15-25

## About Building a Program

This section walks through the process of generating C code and building an executable program from an example model. The resulting stand-alone program runs on your workstation, independent of external timing and events.

## Working and Build Folders

It is convenient to work with a local copy of the `sldemo_f14` model, stored in its own folder, `f14example`. Set up your working folder as follows:

- 1 In the MATLAB Current Folder browser, navigate to a folder where you have write access.

- 2 Create the working folder from the MATLAB command line by typing:

```
mkdir f14example
```

- 3 Make `f14example` your working folder:

```
cd f14example
```

- 4 Open the `sldemo_f14` model:

```
sldemo_f14
```

The model appears in the Simulink window.

- 5 In the model window, choose **File > Save As**. Navigate to your working folder, `f14example`. Save a copy of the `sldemo_f14` model.

During code generation, the Simulink Coder software creates a *build folder* within your working folder. The build folder name is `model_target_rtw`, derived from the name of the source model and the chosen target. The build folder stores generated source code and other files created during the build process. You examine the build folder contents at the end of this example.

---

**Note** When a model contains Model blocks (which enable one Simulink model to include others), special *project folders* are created in your working folder to organize code for referenced models. Project folders exist alongside of Simulink Coder build folders, and are always named `slprj`. “Generate Code for Referenced Models” on page 3-4 describes navigating project folder structures in **Model Explorer**.

---

### **Set Program Parameters**

To generate code from your `sldemo_f14` model, you must change some of the simulation parameters. In particular, note that generic real-time (GRT) and most other targets require that the model specify a fixed-step solver.

---

**Note** The Simulink Coder software can generate code for models using variable-step solvers for rapid simulation (`rsim`) and S-function targets only.

---

To set parameters, use the **Model Explorer** as follows:

- 1** Open Model Explorer by selecting **Model Explorer** from the model’s **View** menu.
- 2** In the **Model Hierarchy** pane, expand the model name node to reveal its components.
- 3** Click **Configuration (Active)** in the left pane.
- 4** Click **Solver** in the center pane. The **Solver** pane appears at the right.
- 5** Enter the following parameter values on the **Solver** pane (some may already be set):
  - **Start time:** 0.0
  - **Stop time:** 60
  - **Type:** Fixed-step
  - **Solver:** ode5 (Dormand-Prince)

- **Fixed step size (fundamental sample time):** 0.1
- **Tasking mode for periodic sample times:** SingleTasking

The **Solver** pane with the modified parameter settings is shown below. Note the tan background color of the controls you just changed. The color also appears on fields that were set automatically by your choices in other fields. Use this visual feedback to verify that what you set is what you intended. When you apply your changes, the background color reverts to white.

The image shows a screenshot of a software interface's Solver pane. It is divided into three sections: Simulation time, Solver options, and Tasking and sample time options. The Simulation time section has 'Start time' set to 0.0 and 'Stop time' set to 60. The Solver options section has 'Type' set to 'Fixed-step', 'Solver' set to 'ode5 (Dormand-Prince)', and 'Fixed-step size (fundamental sample time)' set to 0.1. The Tasking and sample time options section has 'Periodic sample time constraint' set to 'Unconstrained', 'Tasking mode for periodic sample times' set to 'SingleTasking', a checked box for 'Automatically handle rate transition for data transfer', 'Deterministic data transfer' set to 'Whenever possible', and an unchecked box for 'Higher priority value indicates higher task priority'.

Simulation time	
Start time:	0.0
Stop time:	60

Solver options	
Type:	Fixed-step
Solver:	ode5 (Dormand-Prince)
Fixed-step size (fundamental sample time):	0.1

Tasking and sample time options	
Periodic sample time constraint:	Unconstrained
Tasking mode for periodic sample times:	SingleTasking
<input checked="" type="checkbox"/> Automatically handle rate transition for data transfer	
Deterministic data transfer:	Whenever possible
<input type="checkbox"/> Higher priority value indicates higher task priority	

- 6 Click **Apply** to register your changes.
- 7 Save the model. Simulation parameters persist with the model, for use in future sessions.

## Select a Target Configuration

---

**Note** Some of the steps in this section do not require you to make changes. They are included to help you familiarize yourself with the Simulink Coder user interface. As you step through the dialog boxes, place the mouse pointer on any item of interest to see a tooltip describing its function.

---

To specify the desired target configuration, you choose a system target file, a template makefile, and a make command.

In these examples (and in most applications), you do not need to specify these parameters individually. Here, you use the ready-to-run generic real-time target (GRT) configuration. The GRT target is designed to build a stand-alone executable program that runs on your workstation.

To select the GRT target via the **Model Explorer**:

- 1** With the `s1demo_f14` model open, select **View > Model Explorer** to open the Model Explorer.
- 2** In the **Model Hierarchy** pane, expand the model node to reveal its components.
- 3** Click **Configuration (Active)** in the left pane.
- 4** Click **Code Generation** in the center pane. The **Code Generation** pane appears at the right. This pane has several tabs.
- 5** Click the **General** tab to activate the pane that controls target selection.

- 6 Click the **Browse** button next to the **System target file** field. This opens the System Target File Browser, illustrated below. The browser displays a list of all currently available target configurations. Your available configurations may differ. When you select a target configuration, the Simulink Coder software automatically chooses the system target file, template makefile, and make command for that configuration. Their names appear at the bottom left of the window.

**Note** The system target file browser lists all system target files found on the MATLAB path. Using some of these might require additional licensed products, such as the Embedded Coder product.

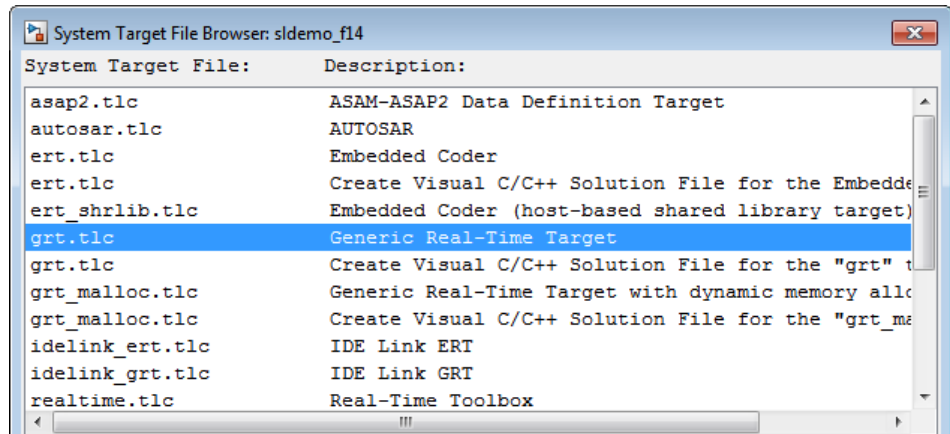

- 7 From the list of available configurations, select **Generic Real-Time Target** (as shown above) and then click **OK**.

The **Code Generation** pane displays the system target file (`grt.tlc`), make command (`make_rtw`), and template makefile (`grt_default_tmf`), as shown below:

Target selection

System target file:

Language:

Description: Generic Real-Time Target

Build process

Compiler optimization level:

TLC options:

Makefile configuration

Generate makefile

Make command:

Template makefile:



- 8** Select the **Code Generation > Debug** pane. The options displayed here control build verbosity and debugging support, and are common to all target configurations. Make sure that all options are set to their defaults, as shown below.

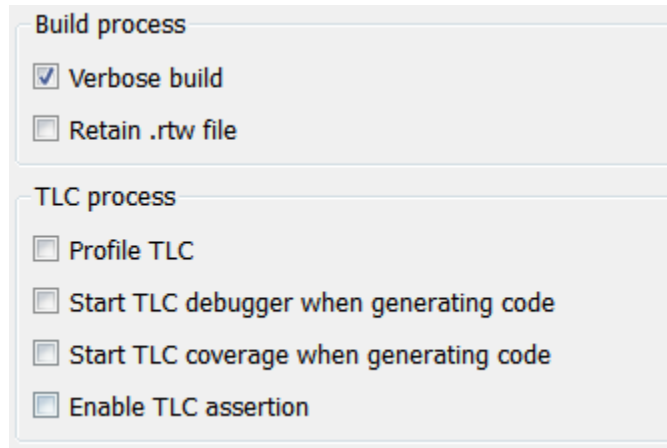

- 9 Select the **Code Generation > Symbols** pane. The options on this pane control the look and feel of generated code.

The image shows a software configuration window titled "Code Generation > Symbols". It contains two main sections:

- Auto-generated identifier naming rules**: A sub-section with a label "Maximum identifier length:" followed by a text input field containing the number "31".
- Reserved names**: A sub-section with a checkbox labeled "Use the same reserved names as Simulation Target" which is currently unchecked. Below this checkbox is a label "Reserved names:" followed by a large, empty rectangular text area.

- 10** Select the **Code Generation > Comments** pane. The options displayed here control the types of comments included in generated code. Make sure that all options are set to their defaults, as shown below.



- 11** Make sure that the **Generate code only** check box at the bottom of the pane is cleared.
- 12** Save the model.

## Build and Run a Program

The Simulink Coder build process generates C code from the model, and then compiles and links the generated program to create an executable image. To build and run the program,

- 1** With the `sldemo_f14` model open, go to the Model Explorer window. In the **Code Generation** pane, click the **Build** button to start the build process.

A number of messages concerning code generation and compilation appear in the MATLAB Command Window. The initial message is

```
### Starting build procedure for model: sldemo_f14
```

The contents of many of the succeeding messages depends on your compiler and operating system. The final message is

```
### Successful completion of build procedure
for model: sldemo_f14
```

The working folder now contains an executable, `sldemo_f14.exe` (Microsoft Windows platforms) or `sldemo_f14` (UNIX platforms). In addition, the Simulink Coder build process has created a project folder, `slprj`, and a build folder, `sldemo_f14_grt_rtw`, in your working folder.

---

**Note** The Simulink Coder build process displays a code generation report after generating the code for the `sldemo_f14` model. The example “Optimizing Generated Code” on page 18-2 provides more information about how to create and use a code generation report.

---

- 2** To observe the contents of the working folder after the build, type the `dir` command from the MATLAB Command Window.

```
dir
```

```
.                sldemo_f14.exe      sldemo_f14_grt_rtw
..               sldemo_f14.slx      slprj
```

- 3** To run the executable from the Command Window, type

```
!sldemo_f14
```

The `!` character passes the command that follows it to the operating system, which runs the stand-alone `sldemo_f14` program.

The program produces one line of output in the Command Window:

```
**starting the model**
```

No data is output.

- 4** Finally, to see the files created in the build folder, type

```
dir sldemo_f14_grt_rtw
```

The exact list of files produced varies among MATLAB platforms and versions. Here is a sample list from a Windows platform.

```
.                grt_main.obj        rt_nonfinite.h
..               html          rt_nonfinite.obj
```

buildInfo.mat	modelsources.txt	rt_rand.c
defines.txt	ode5.obj	rt_rand.h
sldemo_f14.bat	rtGetInf.c	rt_rand.obj
sldemo_f14.c	rtGetInf.h	rt_sim.obj
sldemo_f14.h	rtGetInf.obj	rtmodel.h
sldemo_f14.mk	rtGetNaN.c	rtw_proj.tmw
sldemo_f14.obj	rtGetNaN.h	rtwtypes.h
sldemo_f14_private.h	rtGetNaN.obj	rtwtypeschksum.mat
sldemo_f14_ref.rsp	rt_logging.obj	
sldemo_f14_types.h	rt_nonfinite.c	

## Contents of the Build Folder

The build process creates a build folder and names it *model\_target\_rtw*, where *model* is the name of the source model and *target* is the target selected for the model. In this example, the build folder is named *sldemo\_f14\_grt\_rtw*.

The build folder includes the following generated files.

---

**Note** The code generation report you created for the *sldemo\_f14* model in the previous section displays a link for each file listed below, which you can click to explore the file contents.

---

File	Description
sldemo_f14.c	Standalone C code that implements the model
rt_nonfinite.c rtGetInf.c rtGetNaN.c	Functions to initialize nonfinite types (Inf, NaN, and -Inf)
rt_rand.c	Random functions, included only if used by the application
sldemo_f14.h	An include header file containing definitions of parameters and state variables
sldemo_f14_private.h	Header file containing common include definitions

<b>File</b>	<b>Description</b>
<code>sldemo_f14_types.h</code>	Forward declarations of data types used in the code
<code>rt_nonfinite.h</code> <code>rtGetInf.h</code> <code>rtGetNaN.h</code>	Provides support for nonfinite numbers in the generated code, dynamically generates <code>Inf</code> , <code>NaN</code> , and <code>-Inf</code>
<code>rt_rand.h</code>	Imported declarations for random functions, included only if used by the application
<code>rtmodel.h</code>	Master header file for including generated code in the static main program (its name never changes, and it simply includes <code>sldemo_f14.h</code> )
<code>rtwtypes.h</code>	Static include file for Simulink <code>simstruct</code> data types; some embedded targets tailor this file to reduce overhead, but GRT does not

The build folder contains other files used in the build process, most of which you can disregard for the present:

- `sldemo_f14.mk` — Makefile generated from a template for the GRT target
- Object (`.obj`) files
- `sldemo_f14.bat` — Batch control file
- `rtw_proj.tmw` — Marker file
- `buildInfo.mat` — Build information for relocating generated code to another development environment
- `defines.txt` — Preprocessor defines required for compiling the generated code
- `sldemo_f14_ref.rsp` — Data to include as command-line arguments to `mex` (Windows systems only)

The build folder also contains a subfolder, `html`, which contains the files that make up the code generation report. For more information about the code generation report, see “Reports for Code Generation” on page 11-2.

## Rebuild a Model

If you update generated source code or makefiles manually to add customizations, you can rebuild the files with the `rtwrebuild` command. This command recompiles the modified files by invoking the generated makefile. Alternatively, you can use this command from the Model Explorer,

- 1 In the **Model Hierarchy** pane, expand the node for the model of interest.
- 2 Click the **Code for *model*** node.
- 3 In the **Code** pane, click **run rtwrebuild**, listed to the right of the label **Code Recompile Command**.

## Control Regeneration of Top Model Code

When you rebuild a model, by default, the build process performs checks to determine whether changes to the model or relevant settings require regeneration of the top model code. Top model code is regenerated if any of the following conditions is true:

- The structural checksum of the model has changed.
- The top-model-only checksum has changed. The top-model-only checksum provides information about top model parameters, such as application lifespan, maximum stack size, make command, verbose and `.rtw` file debug settings, and the TLC options parameter.
- Any of the following TLC debugging model options, located on the **Code Generation > Debug** pane of the Configuration Parameters dialog box, is on:
  - **Start TLC debugger when generating code** (TLCDebug)
  - **Start TLC coverage when generating code** (TLCCoverage)
  - **Enable TLC assertion** (TLCAssert)
  - **Profile TLC** (ProfileTLC)

If the checks determine that top model code generation is required, the build process fully regenerates and compiles the model code.

If the checks indicate that the top model generated code is current with respect to the model, and no model settings require full regeneration, the build process omits regeneration of the top model code. This can significantly reduce model build times.

Regardless of whether the top model code is regenerated, the build process subsequently calls all build process hooks, including `STF_make_rtw_hook` functions and the post code generation command, and reruns the makefile so that any external dependencies are recompiled and relinked.

---

**Note** Target authors can perform actions related to code regeneration, including forcing or reacting to code regeneration, in the `STF_make_rtw_hook` functions that are called by the build process. For more information, see “Control Code Regeneration Using `STF_make_rtw_hook.m`” on page 22-26.

---

If you want to control or override the default top model build behavior, use one of the following command-line options:

- To ignore the checksum and force regeneration of the top model code:
  - `rtwbuild(model, 'ForceTopModelbuild', true)`
  - `slbuild(model, 'StandaloneRTWTarget', 'ForceTopModelBuild', true)`
- To clean the model build area enough to trigger regeneration of the top model code at the next build (slbuild only):

```
slbuild(model, 'CleanTopModel')
```

---

**Note** You can also force regeneration of the top model code by deleting code generation folders, for example, `slprj` or the generated model code folder.

---

## Reduce Build Time for Referenced Models

- “Parallel Building For Large Model Reference Hierarchies” on page 15-29
- “Parallel Building Configuration Requirements” on page 15-30
- “Build Models In a Parallel Computing Environment” on page 15-30



- “Locate Parallel Build Logs” on page 15-31

### **Parallel Building For Large Model Reference Hierarchies**

In a parallel computing environment, you can increase the speed of code generation and compilation for models containing large model reference hierarchies by building referenced models in parallel whenever conditions allow. For example, if you have Parallel Computing Toolbox™ software, code generation and compilation for each referenced model can be distributed across the cores of a multicore host computer. If you additionally have MATLAB Distributed Computing Server™ (MDCS) software, code generation and compilation for each referenced model can be distributed across remote workers in your MATLAB Distributed Computing Server configuration.

The performance gain realized by using parallel builds for referenced models depends on several factors, including how many models can be built in parallel for a given model referencing hierarchy, the size of the referenced models, and parallel computing resources such as number of local and/or remote workers available and the hardware attributes of the local and remote machines (amount of RAM, number of cores, and so on).

For configuration requirements that might apply to your parallel computing environment, see “Parallel Building Configuration Requirements” on page 15-30.

For a description of the general workflow for building referenced models in parallel whenever conditions allow, see “Build Models In a Parallel Computing Environment” on page 15-30.

For information on how to configure a custom embedded target to support parallel builds, see “Support Model Referencing” on page 24-101.

---

**Note** In an MDCS parallel computing configuration, parallel building is designed to work interactively with the MATLAB Distributed Computing Server software. You can initiate builds from the Simulink user interface or from the MATLAB Command Window using commands such as `slbuild`. You cannot initiate builds using `batch` or other batch mode workflows.

---

## Parallel Building Configuration Requirements

The following requirements apply to configuring your parallel computing environment for building model reference hierarchies in parallel whenever conditions allow:

- For local pools, the host machine must have enough RAM to support the number of local workers (MATLAB sessions) that you plan to use. For example, setting `matlabpool` to 4 results in five MATLAB sessions on your machine, each using approximately 120 MB of memory at startup.
- Remote MDCS workers participating in a parallel build must use a common platform and compiler.
- A consistent MATLAB environment must be set up in each MATLAB worker session as in the MATLAB client session — for example, all shared base workspace variables, MATLAB path settings, and so forth. One approach is to use the `PreLoadFcn` callback of the top model. If you configure your model to load the top model with each MATLAB worker session, its preload function can be used for any MATLAB worker session setup.

## Build Models In a Parallel Computing Environment

To take advantage of parallel building for a model reference hierarchy:

- 1** Set up a pool of local and/or remote MATLAB workers in your parallel computing environment.
  - a** Make sure that Parallel Computing Toolbox software is licensed and installed.
  - b** To use remote workers, make sure that MATLAB Distributed Computing Server software is licensed and installed.
  - c** Issue MATLAB commands to set up the worker pool, for example, `matlabpool 4`.
- 2** In the Configuration Parameters dialog box, go to the **Model Referencing** pane and select the **Enable parallel model reference builds** option. This selection enables the parameter **MATLAB worker initialization for builds**.

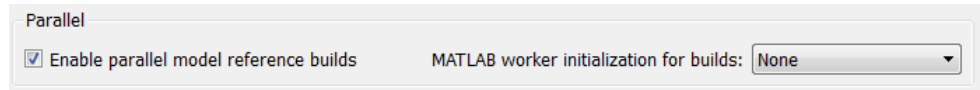

For **MATLAB worker initialization for builds**, select one of the following values:

- **None** if the software should perform no special worker initialization. Specify this value if the child models in the model reference hierarchy do not rely on anything in the base workspace beyond what they explicitly set up (for example, with a model load function).
  - **Copy base workspace** if the software should attempt to copy the base workspace to each worker. Specify this value if you use a setup script to prepare the base workspace for all models to use.
  - **Load top model** if the software should load the top model on each worker. Specify this value if the top model in the model reference hierarchy handles all of the base workspace setup (for example, with a model load function).
- 3** Optionally, inspect the model reference hierarchy to determine, based on model dependencies, which models will be built in parallel. For example, you can use the Model Dependency Viewer from the Simulink **Analysis > Model Dependencies** menu.
  - 4** Build your model. Messages in the MATLAB Command Window record when each parallel or serial build starts and finishes. The order in which referenced models build is nondeterministic. They might build in a different order each time the model is built.

If you need more information about a parallel build, for example, if a build fails, see “Locate Parallel Build Logs” on page 15-31.

### Locate Parallel Build Logs

When you build a model for which referenced models are built in parallel, messages in the MATLAB Command Window record when each parallel or serial build starts and finishes. Any referenced models that build in parallel have only summary log entries in the command window, even if verbose builds are turned on. For example,

```
### Initializing parallel workers for parallel model reference build.
```

```
### Parallel worker initialization complete.
### Starting parallel model reference SIM build for 'bot_model001'
### Starting parallel model reference SIM build for 'bot_model002'
### Starting parallel model reference SIM build for 'bot_model003'
### Starting parallel model reference SIM build for 'bot_model004'
### Finished parallel model reference SIM build for 'bot_model001'
### Finished parallel model reference SIM build for 'bot_model002'
### Finished parallel model reference SIM build for 'bot_model003'
### Finished parallel model reference SIM build for 'bot_model004'
### Starting parallel model reference RTW build for 'bot_model001'
### Starting parallel model reference RTW build for 'bot_model002'
### Starting parallel model reference RTW build for 'bot_model003'
### Starting parallel model reference RTW build for 'bot_model004'
### Finished parallel model reference RTW build for 'bot_model001'
### Finished parallel model reference RTW build for 'bot_model002'
### Finished parallel model reference RTW build for 'bot_model003'
### Finished parallel model reference RTW build for 'bot_model004'
```

If a parallel builds fails, you might see output similar to the following:

```
### Initializing parallel workers for parallel model reference build.
### Parallel worker initialization complete.
...
### Starting parallel model reference RTW build for 'bot_model002'
### Starting parallel model reference RTW build for 'bot_model003'
### Finished parallel model reference RTW build for 'bot_model002'
### Finished parallel model reference RTW build for 'bot_model003'
### Starting parallel model reference RTW build for 'bot_model001'
### Starting parallel model reference RTW build for 'bot_model004'
### Finished parallel model reference RTW build for 'bot_model004'
### The following error occurred during the parallel model reference RTW build for
'bot_model001':

Error(s) encountered while building model "bot_model001"

### Cleaning up parallel workers.
```

To obtain more detailed information about the failed build, you can examine the parallel build log. For each referenced model built in parallel, the build process generates a file named *model\_buildlog.txt*, where *model* is the

name of the referenced model. This file contains the full build log for that model.

If a parallel build completes, the build log file is placed in the build subfolder corresponding to the referenced model. For example, for a build of referenced model `bot_model004`, you would look for the build log file `bot_model004_buildlog.txt` in a referenced model subfolder such as `build_folder/slprj/grt/bot_model004`, `build_folder/slprj/ert/bot_model004`, or `build_folder/slprj/sim/bot_model004`.

If a parallel build fails, the build log can be found in a referenced model subfolder under the build subfolder `/par_md1_ref/model`. For example, for a failed parallel build of model `bot_model001`, you would look for the build log file `bot_model001_buildlog.txt` in a subfolder such as `build_folder/par_md1_ref/bot_model001/slprj/grt/bot_model001`, `build_folder/par_md1_ref/bot_model001/slprj/ert/bot_model001`, or `build_folder/par_md1_ref/bot_model001/slprj/sim/bot_model001`.

## Relocate Code to Another Development Environment

- “About Code Relocation” on page 15-33
- “Package Code Using the Graphical User Interface” on page 15-34
- “Package Code Using the Command-Line Interface” on page 15-34
- “packNGo Function Limitations” on page 15-38

### About Code Relocation

If you need to relocate the static and generated code files for a model to another development environment, such as a system or an integrated development environment (IDE) that does not include MATLAB and Simulink products, use the Simulink Coder pack-and-go utility. This utility uses the tools for customizing the build process after code generation and a packNGo function to find and package files for building an executable image. The files are packaged in a compressed file that you can relocate and unpack using a standard zip utility.

To package model code files, you can do either of the following:

- Use the model option **Package code and artifacts** on the **Code Generation** pane of the Configuration Parameters dialog box. See “Package Code Using the Graphical User Interface” on page 15-34.
- Use MATLAB commands to configure a `PostCodeGenCommand` parameter with a call to the `packNGo` function. See “Package Code Using the Command-Line Interface” on page 15-34. The command-line interface provides more control over the details of code packaging.

### Package Code Using the Graphical User Interface

To package and relocate code for your model using the graphical user interface:

- 1 Open the Configuration Parameters dialog box and select the **Code Generation** pane.
- 2 Select the option **Package code and artifacts**. This option configures the build process to run the `packNGo` function after code generation to package generated code and artifacts for relocation.
- 3 In the **Zip file name** field, enter the name of the zip file in which to package generated code and artifacts for relocation. The file name can be specified with or without the `.zip` extension. If you specify no extension or an extension other than `.zip`, the zip utility adds the `.zip` extension. If no value is specified, the build process uses the name `model.zip`, where `model` is the name of the top model for which code is being generated.

The screenshot shows a portion of the Configuration Parameters dialog box. On the left, there are two checkboxes: 'Generate code only' (unchecked) and 'Package code and artifacts' (checked). On the right, there is a 'Build' button and a text field labeled 'Zip file name:' containing the text 'rtwdemo\_rtwintr'.

- 4 Apply changes and generate code for your model. Inspect the resulting zip file to verify that it is ready for relocation. Depending on the zip tool you use you might be able to open and inspect the file without unpacking it.
- 5 Relocate the zip file to the destination development environment and unpack the file.

### Package Code Using the Command-Line Interface

To package and relocate code for your model using the command-line interface:

- 1 Select a structure for the zip file.
- 2 Select a name for the zip file.
- 3 Package the model code files in the zip file.
- 4 Inspect the generated zip file.
- 5 Relocate and unpack the zip file.

**Select a Structure for the Zip File.** Before you generate and package the files for a model build, decide whether you want the files to be packaged in a flat or hierarchical folder structure. By default, the `packNGo` function packages the files in a single, flat folder structure. This is the simplest approach and might be the optimal choice.

If...	Then Use a...
You are relocating files to an IDE that does not use the generated makefile or the code is not dependent on the relative location of required static files	Single, flat folder structure
The target development environment must maintain the folder structure of the source environment because it uses the generated makefile or the code is dependent on the relative location of files	Hierarchical structure

If you use a hierarchical structure, the `packNGo` function creates two levels of zip files, a primary zip file, which in turn contains the following secondary zip files:

- `mlrFiles.zip` — files in your *matlabroot* folder tree
- `sDirFiles.zip` — files in and under your build folder where you initiated the model's code generation
- `otherFiles.zip` — required files not in the *matlabroot* or *start* folder trees

Paths for the secondary zip files are relative to the root folder of the primary zip file, maintaining the source development folder structure.

**Select a Name for the Zip File.** By default, the `packNGo` function names the primary zip file `model..` You have the option of specifying a different name. If you specify a file name and omit the file type extension, the function appends `.zip` to the name you specify.

**Package Model Code in a Zip File.** You package model code files by using the `PostCodeGenCommand` configuration parameter, `packNGo` function, and the model's build information object. You can set up the packaging operation to use

- A system generated build information object.

In this case, use `set_param` to set the configuration parameter `PostCodeGenCommand` to an explicit call to the `packNGo` function before generating the model code. For example:

```
set_param(bdroot, 'PostCodeGenCommand', 'packNGo(buildInfo);');
```

This command instructs the Simulink Coder build process to evaluate the call to `packNGo`, using the system generated build information object for the currently selected model, after generating and writing the model's code to disk and before generating a makefile.

- A build information object that you construct programmatically, as explained in “Customize Post-Code-Generation Build Processing” on page 22-13.

In this case, you might use other build information functions to selectively include paths and files in the build information object that you then specify with the `packNGo` function. For example:

```
.  
. .  
. .  
myModelBuildInfo = RTW.BuildInfo;  
addSourceFiles(myModelBuildInfo, {'test1.c' 'test2.c' 'driver.c'});  
. .  
. .  
. .
```



```
packNGo(myModelBuildInfo);
```

To change the default behavior of `packNGo`, see the following examples:

To...	Specify...
Change the structure of the file packaging to hierarchical	<code>packNGo(buildInfo, {'packType' 'hierarchical'});</code>
Rename the primary zip file	<code>packNGo(buildInfo, {'fileName' 'zippedsrcs'});</code>
Change the structure of the file packaging to hierarchical and rename the primary zip file	<code>packNGo(buildInfo, {'packType' 'hierarchical'... 'fileName' 'zippedsrcs'});</code>
Include all header files found on the include path (rather than the minimal header files required to build the code) in the zip file	<code>packNGo(buildInfo, {'minimalHeaders' false});</code>

---

**Note** The `packNGo` function potentially can modify the build information passed in the first `packNGo` argument. As part of packaging model code, `packNGo` might find additional files from source and include paths recorded in the model's build information and add them to the build information.

---

**Inspect a Generated Zip File.** Inspect the generated zip file to verify that it is ready for relocation. Depending on the zip tool you use you might be able to open and inspect the file without unpacking it. If you need to unpack the file and you packaged the model code files as a hierarchical structure, you will need to unpack the primary and secondary zip files. When you unpack the secondary zip files, relative paths of all files are preserved.

**Relocate and Unpack a Zip File.** Relocate the generated zip file to the destination development environment and unpack the file.

**Code Packaging Example.** The following example guides you through the steps for packaging code files generated for the example model `rtwdemo_rtwinintro` using the command-line interface:

- 1 Set your working folder to a writable folder.
- 2 Open the model `rtwdemo_rtwinintro` and save a copy to your working folder.
- 3 Enter the following command in the MATLAB Command Window:

```
set_param('rtwdemo_rtwinintro', 'PostCodeGenCommand', ...  
'packNGo(buildInfo, {'packType' ' ' 'hierarchical'})');
```

You must double the single-quotes due to the nesting of character arrays `'packType'` and `'hierarchical'` within the character array that specifies the call to `packNGo`.

- 4 Generate code for the model.
- 5 Inspect the generated zip file, `rtwdemo_rtwinintro.zip`. The zip file contains the two secondary zip files, `mlrFiles.zip` and `sDirFiles.zip`.
- 6 Inspect the zip files `mlrFiles.zip` and `sDirFiles.zip`.
- 7 Relocate the zip file to a destination environment and unpack it.

### **packNGo Function Limitations**

The following limitations apply to use of the `packNGo` function:

- The function operates on source files, such as `*.c`, `*.cpp`, and `*.h` files, only. The function does not support compile flags, defines, or makefiles.
- Unnecessary files might be included. The function might find additional files from source and include paths recorded in the model's build information and include them, even if they are not used.

### **How Executable Programs Are Built From Models**

- “Build Process Steps” on page 15-39
- “Customized Makefile Generation” on page 15-39

- “Executable Program Generation” on page 15-40

## Build Process Steps

The Simulink Coder software generates C code only or generates the C code and produces an executable image, depending on the level of processing you choose. By default, a **Build** button appears on the **Code Generation** pane of the Configuration Parameters dialog box. This button completes the entire build process and an executable image results. If you select the **Generate code only** check box to the left of the button, the button label changes to **Generate code**.

When you click the **Build** or **Generate code** button, the Simulink Coder software performs the following build process. If the software detects code generation constraints for your model, it issues warning or error messages.

- 1 “Model Compilation” on page 10-31
- 2 “Code Generation” on page 10-31
- 3 “Customized Makefile Generation” on page 15-39
- 4 “Executable Program Generation” on page 15-40

For more information, see “Generate a Code Generation Report” on page 11-5. You can also view an HTML report in **Model Explorer**.

## Customized Makefile Generation

After generating the code, the Simulink Coder software generates a customized makefile, *model.mk*. The generated makefile instructs the make system utility to compile and link source code generated from the model, as well as any required harness program, libraries, or user-provided modules.

The Simulink Coder software creates *model.mk* from a system template file, *system.tmf* (where *system* stands for the selected target name). The system template makefile is designed for your target environment. You have the option of modifying the template makefile to specify compilers, compiler options, and additional information used during the creation of the executable.

The Simulink Coder software creates the *model.mk* file by copying the contents of *system.tmf* and expanding lexical tokens (symbolic names) that describe your model's configuration.

The Simulink Coder software provides many system template makefiles, configured for specific target environments and development systems. "Selecting a Target" on page 9-34 in the Simulink Coder documentation lists all template makefiles that are bundled with the Simulink Coder software. To see an example template makefile, navigate to `matlabroot/rtw/c/grt`, and open with an editor the file `grt_msvc.tmf`. You can fully customize your build process by modifying an existing template makefile or providing your own template makefile.

### **Executable Program Generation**

The following figure shows how the Simulink Coder software controls automatic program building.

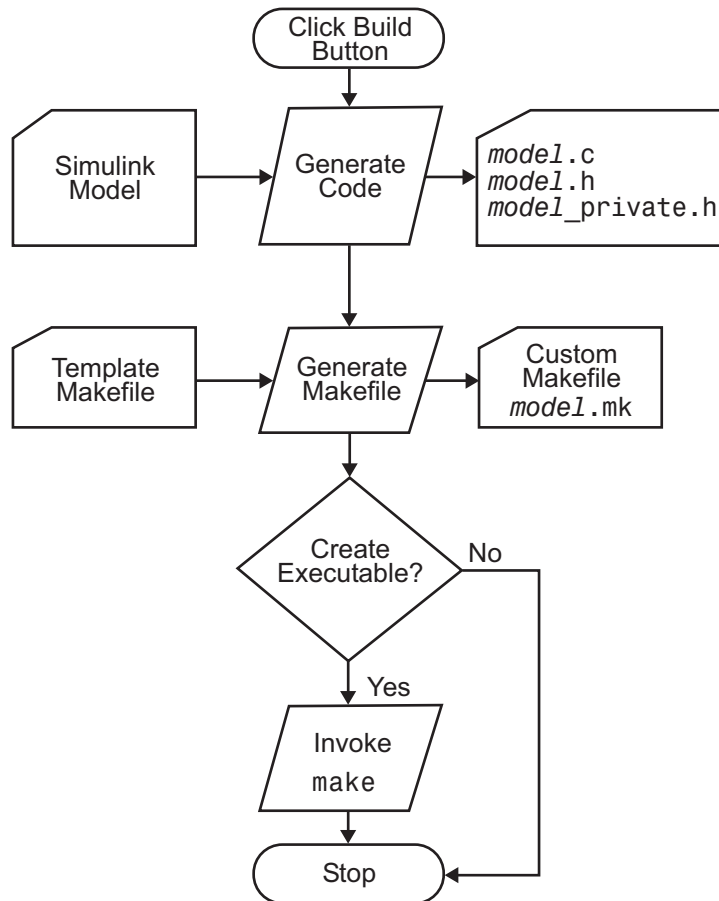

During the final stage of processing, the Simulink Coder build process invokes the generated makefile, `model.mk`, which in turn compiles and links the generated code. On PC platforms, a batch file is created to invoke the generated makefile. The batch file sets up the environment for invoking the `make` utility and related compiler tools. To avoid recompilation of C files, the `make` utility performs date checking on the dependencies between the object and C files; only out-of-date source files are compiled. Optionally, the makefile can download the resulting executable image to your target hardware.

This stage is optional, as illustrated by the control logic in the preceding figure. You might choose to omit this stage, for example, if you are targeting an embedded microcontroller or a digital signal processing (DSP) board.

To omit this stage of processing, select the **Generate code only** check box on the **Code Generation** pane of the Configuration Parameters dialog box. You can then cross-compile your code and download it to your target hardware.

If you select **Create code generation report** on the **Code Generation > Report** pane, a navigable summary of source files is produced when the model is built. The report files occupy a folder called `html` within the build folder. The report contents vary depending on the target, but all reports feature links to generated source files. The following display shows an example of an HTML code generation report for a generic real-time (GRT) target.

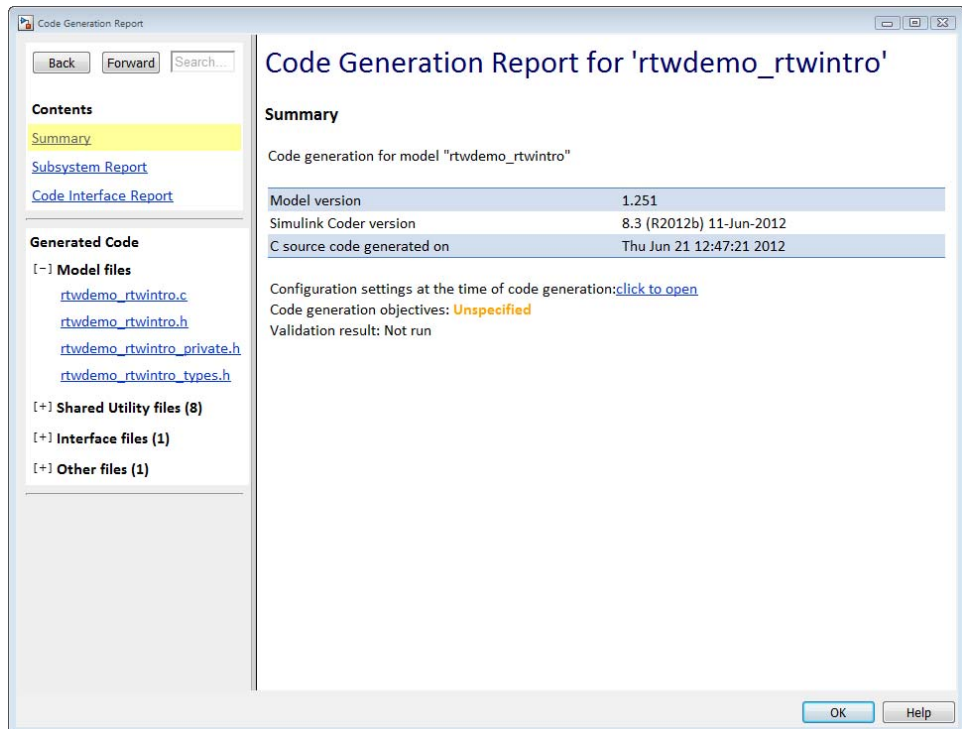

The screenshot displays a web browser window titled "Code Generation Report for 'rtwdemo\_rtwintr0'". The interface includes a navigation pane on the left with "Back", "Forward", and "Search..." buttons. The "Contents" section lists "Summary" (highlighted), "Subsystem Report", and "Code Interface Report". The "Generated Code" section is expanded to show "Model files" (rtwdemo\_rtwintr0.c, .h, .private.h, .types.h), "Shared Utility files (8)", "Interface files (1)", and "Other files (1)". The main content area, titled "Summary", provides details for model "rtwdemo\_rtwintr0":

Model version	1.251
Simulink Coder version	8.3 (R2012b) 11-Jun-2012
C source code generated on	Thu Jun 21 12:47:21 2012

Additional information includes: Configuration settings at the time of code generation: [click to open](#); Code generation objectives: **Unspecified**; and Validation result: Not run. The window concludes with "OK" and "Help" buttons.

## Build and Run a Program

The Simulink Coder build process generates C code from the model, and then compiles and links the generated program to create an executable image. To build and run the program,

- 1 With the `sldemo_f14` model open, go to the Model Explorer window. In the **Code Generation** pane, click the **Build** button to start the build process.

A number of messages concerning code generation and compilation appear in the MATLAB Command Window. The initial message is

```
### Starting build procedure for model: sldemo_f14
```

The contents of many of the succeeding messages depends on your compiler and operating system. The final message is

```
### Successful completion of build procedure
for model: sldemo_f14
```

The working folder now contains an executable, `sldemo_f14.exe` (Microsoft Windows platforms) or `sldemo_f14` (UNIX platforms). In addition, the Simulink Coder build process has created a project folder, `slprj`, and a build folder, `sldemo_f14_grt_rtw`, in your working folder.

---

**Note** The Simulink Coder build process displays a code generation report after generating the code for the `sldemo_f14` model. The example “Optimizing Generated Code” on page 18-2 provides more information about how to create and use a code generation report.

---

- 2 To observe the contents of the working folder after the build, type the `dir` command from the MATLAB Command Window.

```
dir
```

```
.          sldemo_f14.exe      sldemo_f14_grt_rtw
..         sldemo_f14.slx   slprj
```

- 3 To run the executable from the Command Window, type

```
!sldemo_f14
```

The ! character passes the command that follows it to the operating system, which runs the stand-alone sldemo\_f14 program.

The program produces one line of output in the Command Window:

```
**starting the model**
```

No data is output.

- 4** Finally, to see the files created in the build folder, type

```
dir sldemo_f14_grt_rtw
```

The exact list of files produced varies among MATLAB platforms and versions. Here is a sample list from a Windows platform.

```
.                grt_main.obj      rt_nonfinite.h
..               html              rt_nonfinite.obj
buildInfo.mat    modelsources.txt  rt_rand.c
defines.txt      ode5.obj          rt_rand.h
sldemo_f14.bat   rtGetInf.c        rt_rand.obj
sldemo_f14.c     rtGetInf.h        rt_sim.obj
sldemo_f14.h     rtGetInf.obj      rtmodel.h
sldemo_f14.mk    rtGetNaN.c        rtw_proj.tmw
sldemo_f14.obj   rtGetNaN.h        rtwtypes.h
sldemo_f14_private.h  rtGetNaN.obj    rtwtypeschksum.mat
sldemo_f14_ref.rsp  rt_logging.obj
sldemo_f14_types.h  rt_nonfinite.c
```



# Profile Code Performance

**In this section...**

“About Profiling Code Performance” on page 15-45

“How to Profile Code Performance” on page 15-45

“Run Profiling Hooks for Generated Code” on page 15-48

“Profiling Limitation” on page 15-49

## About Profiling Code Performance

By profiling the performance of generated code, you can help verify that the code meets performance requirements. Profiling can be especially important early in the development cycle for identifying potential architectural issues that can be more expensive to address later in the process. Profiling can also identify bottlenecks and procedural issues that indicate a need for optimization, for example, with an inner loop or inline code.

---

**Note** If you have an Embedded Coder license, see “Code Execution Profiling” for an alternative and simpler approach based on software-in-the-loop (SIL) or processor-in-the-loop (PIL) simulations.

---

## How to Profile Code Performance

You can profile code generated with code generation technology by using a Target Language Compiler (TLC) hook function interface.

To use the profile hook function interface:

- 1 For your target, create a TLC file that defines the following hook functions. Write the functions so that they specify profiling code. The code generator adds the hook function code to code generated for atomic systems in the model.

<b>Function</b>	<b>Input Arguments</b>	<b>Output Type</b>	<b>Description</b>
ProfilerHeaders	void	Array of header file names	Return an array of the header file names to be included in the generated code.
ProfilerTypedefs	void	typedefs	Generate code statements for profiler type definitions.
ProfilerGlobal-Data	system	Global data for the specified system	Generate code statements that declare global data.
ProfilerExtern-DataDecls	system	extern declarations for the specified system	Generate code statements that create global extern declarations.
ProfilerSystem-Decls	system, functionType	Declarations for the specified system for the specified functionType	Generate code for required variable declarations within the scope of an atomic subsystem Output, Update, OutputUpdate, or Derivatives function.
ProfilerSystem-Start	system, functionType	Profiler start commands for the specified system and functionType	Generate code that starts the profiler within the scope of an atomic subsystem Output, Update, OutputUpdate, or Derivatives function.

Function	Input Arguments	Output Type	Description
ProfilerSystem-Finish	system, functionType	Profiler end commands for the specified system and functionType	Generate code that stops the profiler within the scope of an atomic subsystem's Output, Update, OutputUpdate, or Derivatives function.
ProfilerSystem-Terminate	system	Profiler termination code for the specified system	Generate code that terminates profiling (and possibly reports results) for an atomic subsystem.

For an example TLC file, see  
`matlabroot/toolbox/rtw/rtwdemos/rtwdemo_profile_hook.tlc`.

- 2** In your `target.tlc` file, define the following global variables.

Define...	To Be...
ProfileGenCode	TLC_TRUE or 1 to turn on profiling (TLC_FALSE or 0 to turn off profiling)
ProfilerTLC	The name of the TLC file that you created in step 1

A quick way to define global variables is to define the parameters with the `-a` option. You can do this in the Configuration Parameters dialog box, in **Code Generation > TLC options**.

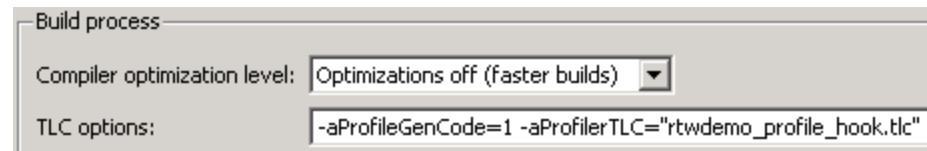

- 3** Consider setting configuration parameters for generating a code generation report. You can then examine the profiling code in the context of the code generated for the model.

- 4** Build the model. The build process embeds the profiling code in the hook function locations in the generated code for the model.
- 5** Run the generated executable file. In the MATLAB Command Window, enter `!model -name` . You see the profiling report you programmed in the profiling TLC file that you created. For example, a profile report might list the number of calls made to each system in a model and the number of CPU cycles spent in each system.

For an example, see “Run Profiling Hooks for Generated Code” on page 15-48. For details on programming a `.tlc` file and defining TLC configuration variables, see “Target Language Compiler”.

## Run Profiling Hooks for Generated Code

The example Profiling Hooks for Generated Code shows how to use special hooks provided by Simulink Coder to add profiling code snippets to the generated code for your models.

The basis for this example is the Target Language Compiler (TLC) hook function interface described in “How to Profile Code Performance” on page 15-45. The hooks allow you to add profiling code snippets within nonvirtual (atomic) systems in the model, which allow you to profile those atomic systems. For this example, the file `matlabroot/toolbox/rtw/rtwdemos/rtwdemo_profile_hook.tlc` implements the required profiling functions. You can inspect this file for more information on each of the profiling functions.

Run the example as follows:

- 1** Open the model `rtwdemo_profile`; for example, you can enter the command `rtwdemo_profile` in the MATLAB Command Window.
- 2** Change your working folder to one for which you have write permission.
- 3** Double-click one of the Generate Code blocks. This configures the selected code generation target options with the profiling hooks and builds the model. When the build process is completed, a window opens with a display of the generated code. Browse through the code to see the profile-specific C code that has been generated.

- 4 Enter `!rtwdemo_profile` in the MATLAB Command Window to run the generated executable file. This command displays a textual report of the number of calls made to each system in the example model and the number of CPU cycles that were spent in each system.

### **Profiling Limitation**

The TLC hook function interface for profiling code performance does not support the S-function target (`rtwsfcn.tlc`).

## Data Exchange

### In this section...

- “Host/Target Communication” on page 15-50
- “Logging” on page 15-105
- “Parameter Tuning” on page 15-119
- “Data Interchange Using the C API” on page 15-137
- “ASAP2 Data Measurement and Calibration” on page 15-174
- “Direct Memory Access to Generated Code” on page 15-189

### Host/Target Communication

- “About Host/Target Communication” on page 15-50
- “Set Up an External Mode Communication Channel” on page 15-51
- “Use the External Mode User Interface” on page 15-63
- “External Mode Compatible Blocks and Subsystems” on page 15-83
- “External Mode Communication” on page 15-86
- “Choose Communication Protocol for Client and Server” on page 15-89
- “Use External Mode Programmatically” on page 15-98
- “External Mode Limitations” on page 15-103

### About Host/Target Communication

External mode allows two separate systems, a *host* and a *target*, to communicate. The host is the computer where the MATLAB and Simulink environments execute. The target is the computer where the executable created by the code generation and build process runs.

The host (the Simulink environment) transmits messages requesting the target to accept parameter changes or to upload signal data. The target responds by executing the request. External mode communication is based

on a *client/server* architecture, in which the Simulink environment is the client and the target is the server.

External mode lets you

- Modify, or *tune*, block parameters in real time. In External mode, whenever you change parameters in the block diagram, the Simulink engine downloads them to the executing target program. This lets you tune your program's parameters without recompiling.
- View and log block outputs in many types of blocks and subsystems. You can monitor and/or store signal data from the executing target program, without writing special interface code. You can define the conditions under which data is uploaded from target to host. For example, data uploading could be triggered by a selected signal crossing zero in a positive direction. Alternatively, you can manually trigger data uploading.

External mode works by establishing a communication channel between the Simulink engine and generated code. The channel's low-level *transport layer* handles the physical transmission of messages. The Simulink engine and the generated model code are independent of this layer. The transport layer and the code directly interfacing to it are isolated in separate modules that format, transmit, and receive messages and data packets.

This design allows for different targets to use different transport layers. ERT, GRT, GRT malloc, and RSim targets support External mode host/target communication by using TCP/IP and RS-232 (serial) communication. The xPC Target product uses a customized transport layer. The Wind River Systems Tornado target supports TCP/IP only. The Real-Time Windows Target product uses shared memory.

## Set Up an External Mode Communication Channel

- “About Setting Up External Mode Communication Channels” on page 15-52
- “Set Up the Model” on page 15-52
- “Build the Target Executable” on page 15-54
- “Run the External Mode Target Program” on page 15-58
- “Tune Parameters” on page 15-62

**About Setting Up External Mode Communication Channels.** This section provides step-by-step instructions for getting started with External mode, a very useful environment for rapid prototyping. The example consists of four parts, each of which depends on completion of the preceding ones, in order. The four parts correspond to the steps that you follow in simulating, building, and tuning an actual real-time application:

- 1** Set up the model.
- 2** Build the target executable.
- 3** Run the External mode target program.
- 4** Tune parameters.

The example presented uses the GRT target, and does not require hardware other than the computer on which you run the Simulink and Simulink Coder software. The generated executable in this example runs on the host computer in a separate process from MATLAB and Simulink.

The procedures for building, running, and testing your programs are almost identical in UNIX and PC environments. The discussion notes differences where applicable.

**Set Up the Model.** In this part of the example, you create a simple model, `extmode_example`, and a folder called `ext_mode_example` to store the model and the generated executable:

- 1** Create the folder from the MATLAB command line by typing

```
mkdir ext_mode_example
```

- 2** Make `ext_mode_example` your working folder:

```
cd ext_mode_example
```



- 3 Create a model in Simulink with a Sine Wave block for the input signal, two Gain blocks in parallel, and two Scope blocks. The model is shown below. Be sure to label the Gain and Scope blocks as shown, so that subsequent steps will be clear to you.

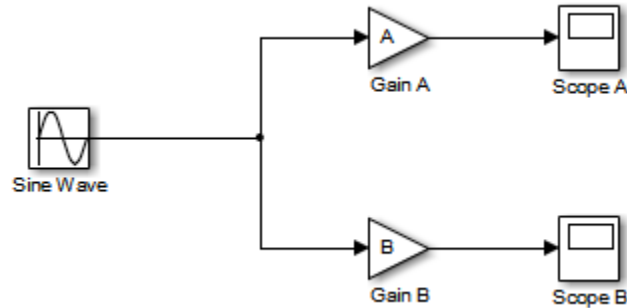

- 4 Define and assign two variables A and B in the MATLAB workspace as follows:

```
A = 2; B = 3;
```

- 5 Open Gain block A and set its **Gain** parameter to the variable A.

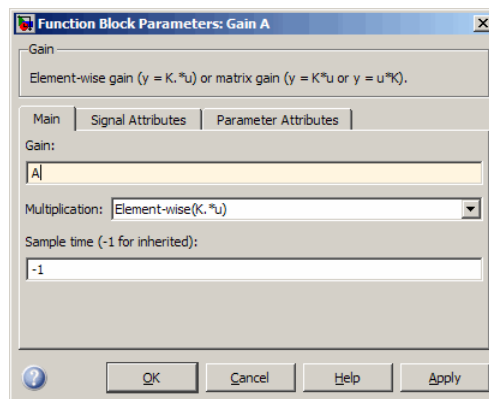

- 6 Similarly, open Gain block B and set its **Gain** parameter to the variable B.

When the target program is built and connected to Simulink in External mode, you can download new gain values to the executing target program by assigning new values to workspace variables **A** and **B**, or by editing the values in the block parameters dialog. You explore this in “Tune Parameters” on page 15-62.

- 7 Verify operation of the model. Open the Scope blocks and run the model. When  $A = 2$  and  $B = 3$ , the output looks like this.

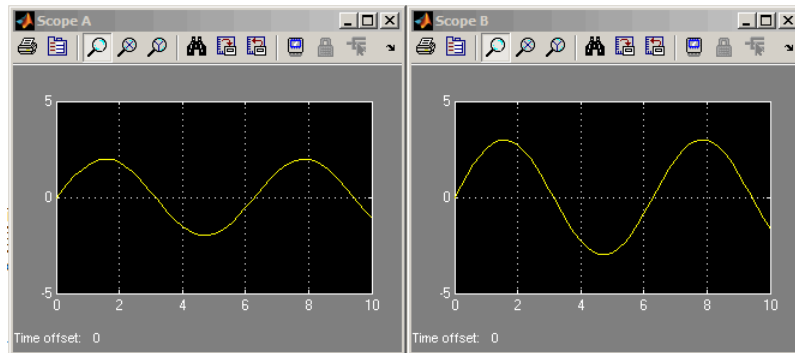

- 8 From the **File** menu, choose **Save As**. Save the model as `extmode_example`.

**Build the Target Executable.** In this section, you set up the model and code generation parameters required for an External mode compatible target program. Then you generate code and build the target executable:

- 1 Open Model Explorer by selecting **Model Explorer** from the model’s **View** menu.
- 2 In the **Model Hierarchy** pane, click the + sign preceding the model name to reveal its components.
- 3 Click **Configuration (Active)** in the left pane.
- 4 Select **Solver** in the center pane. The **Solver** pane appears at the right.

- 5 In the **Solver options** subpane:
  - a Select **Fixed-step** in the **Type** field.
  - b Select **discrete (no continuous states)** in the **Solver** field.
  - c Specify **0.1** in the **Fixed-step size** field. (Otherwise, the Simulink Coder build process posts a warning and supplies a value when you generate code.)
- 6 Click **Apply**. The **Solver options** subpane appears below. Note that after you click **Apply**, the controls you changed again have a white background color.

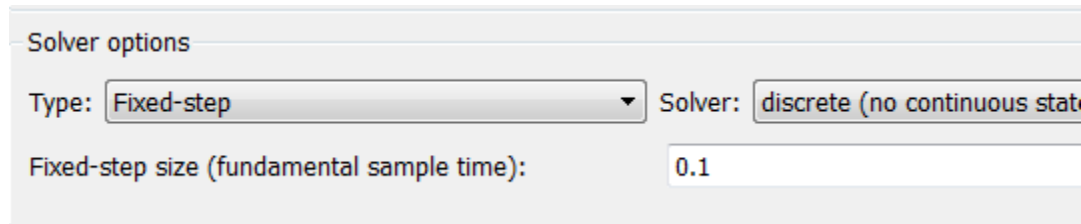

- 7 Click **Data Import/Export** in the center pane, and clear the **Time** and **Output** check boxes. In this example, data is not logged to the workspace or to a MAT-file. Click **Apply**.
- 8 Click **Optimization** in the center pane and click the **Signals and Parameters** tab in the right pane. Make sure that the **Inline parameters** option is *not* selected. Although External mode supports inlined parameters, you will not explore them in this example. Click **Apply** if you have made any changes.
- 9 Click **Code Generation** in the center pane. By default, the generic real-time (GRT) target is selected on the **Code Generation** pane. Select the **Interface** tab. The **Interface** pane appears at the right.
- 10 On the **Interface** pane, select **External** mode from the **Interface** pull-down menu in the **Data exchange** section. This enables generation of External mode support code and reveals two more sections of controls: **Host/Target interface** and **Memory management**.

- 11** In the **Host/Target interface** section, make sure that the value `tcpip` is selected for the **Transport layer** parameter. The **Data exchange** section now looks like this:

The screenshot shows the 'Data exchange' configuration window. It has several sections:
 

- Data exchange:** Includes a checked 'MAT-file logging' checkbox and a 'MAT-file variable name modifier' dropdown set to 'rt\_'.
- Interface:** A dropdown menu set to 'External mode'.
- Host/Target interface:** Contains a 'Transport layer' dropdown set to 'tcpip', a 'MEX-file name' field with 'ext\_comm', and an empty 'MEX-file arguments' text box.
- Memory management:** Includes an unchecked 'Static memory allocation' checkbox.

External mode supports communication via TCP/IP, serial, and custom transport protocols. The **MEX-file name** field specifies the name of a MEX-file that implements host and target communications on the host side. The default for TCP/IP is `ext_comm`, a MEX-file provided with the Simulink Coder software. You can override this default by supplying other files. See “Create a Transport Layer for External Communication” on page 23-14 in the Simulink Coder documentation for details if you need to support other transport layers.

The **MEX-file arguments** field lets you specify arguments, such as a TCP/IP server port number, to be passed to the external interface program. Note that these arguments are specific to the external interface you are using. For information on setting these arguments, see **MEX-File Optional Arguments for TCP/IP Transport** on page 92 and **MEX-File Optional Arguments for Serial Transport** on page 94 in the Simulink Coder documentation.

This example uses the default arguments. Leave the **MEX-file arguments** field blank.

- 12** Click **Apply** to save the **Interface** settings.
- 13** Save the model.

- 14 Click **Code Generation** in the center pane of the **Model Explorer**. On the right, make sure that **Generate code only** is cleared, then click the **Build** button to generate code and create the target program. The content of subsequent messages depends on your compiler and operating system. The final message is

```
### Successful completion of build procedure for model: extmode_example
```

In the next section, you will run the `extmode_example` executable and use Simulink as an interactive front end to the running target program.

**Run the External Mode Target Program.** The target executable, `extmode_example`, is now in your working folder. In this section, you run the target program and establish communication between Simulink and the target.

---

**Note** An external-mode program like `extmode_example` is a host-based executable. Its execution is not tied to RTOS or a periodic timer interrupt, and it does not run in real time. The program just runs as fast as possible, and the time units it counts off are simulated time units that do not correspond to time in the world outside the program.

---

The External Signal & Triggering dialog box (accessed via the External Mode Control Panel) displays a list of all the blocks in your model that support External mode signal monitoring and logging. The dialog box also lets you configure the signals that are viewed and how they are acquired and displayed. You can use it to reconfigure signals while the target program runs.

In this example, you observe and use the default settings of the External Signal & Triggering dialog box.

- 1 From the **Code** menu of the model diagram, select **External Mode Control Panel**, which lets you configure signal monitoring and data archiving. It also lets you connect to the target program and start and stop execution of the model code.

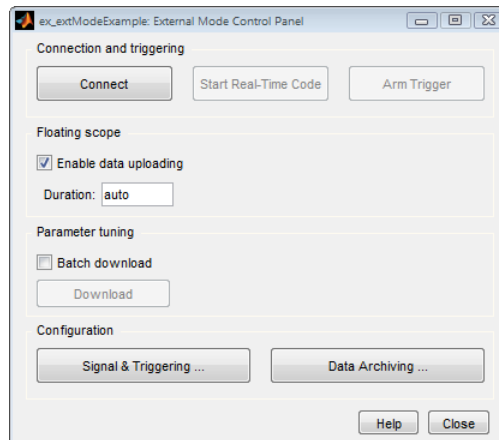

The top three buttons are for use after the target program has started. The two lower buttons open separate dialog boxes:

- The **Signal & triggering** button opens the **External Signal & Triggering** dialog box. This dialog box lets you select the signals that are collected from the target system and viewed in External mode. It also lets you select a signal that triggers uploading of data when certain signal conditions are met, and define the triggering conditions.
- The **Data archiving** button opens the **External Data Archiving** dialog box. Data archiving lets you save data sets generated by the target program for future analysis. This example does not use data archiving. See “Data Archiving” on page 15-79 in the Simulink Coder documentation for more information.

- 2 In the External Mode Control Panel, click the **Signal & Triggering** button. The **External Signal & Triggering** dialog box opens. The default configuration of the **External Signal & Triggering** dialog box is designed to select all signals for monitoring. The default configuration sets signal monitoring to begin as soon as the host and target programs have connected. The figure below shows the default configuration for `extmode_example`.

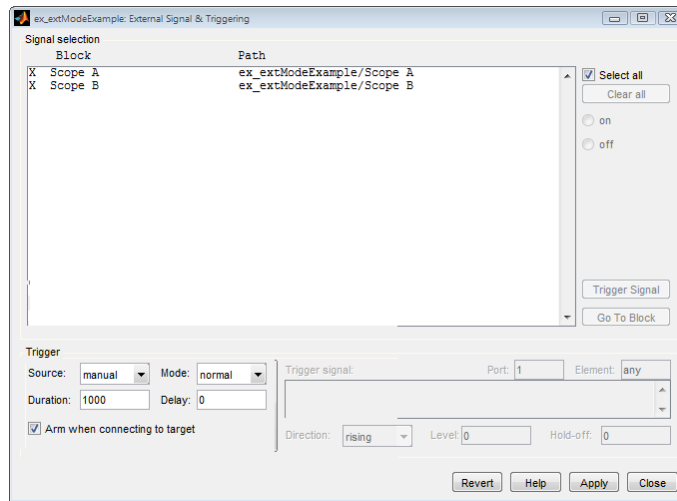



- 3** Make sure that the **External Signal & Triggering** dialog box is set to the defaults as shown:
- **Select all** check box is selected. All signals in the **Signal selection** list are marked with an X in the **Block** column.
  - **Trigger Source:** manual
  - **Trigger Mode:** normal
  - **Duration:** 1000
  - **Delay:** 0
  - **Arm when connecting to target:** selected

Click **Close**, and then close the External Mode Control Panel.

For information on the options mentioned above, see “External Signal Uploading and Triggering” on page 15-75 in the Simulink Coder documentation.

- 4** To run the target program, you must open a command prompt window (on UNIX systems, an Xterm window). At the command prompt, change to the `ext_mode_example` folder that you created in step 1. The target program is in this folder.

```
cd ext_mode_example
```

Next, type the following command:

```
extmode_example -tf inf -w
```

and press **Return**.

---

**Note** On Microsoft Windows platforms, you can also use the “bang” command (!) in the MATLAB Command Window (note that the trailing ampersand is required):

```
!extmode_example -tf inf -w &
```

---

The target program begins execution. Note that the target program is in a wait state, so no activity occurs in the MATLAB Command Window.

The `-tf` switch overrides the stop time set for the model in Simulink. The `inf` value directs the model to run indefinitely. The model code runs until the target program receives a stop message from Simulink.

The `-w` switch instructs the target program to enter a wait state until it receives a **Start Real-Time Code** message from the host. This switch is required if you want to view data from time step 0 of the target program execution, or if you want to modify parameters before the target program begins execution of model code.

- 5** Open Scope blocks A and B. At this point, no signals are visible on the scopes. When you connect Simulink to the target program and begin model execution, the signals generated by the target program will be visible on the scope displays.
- 6** The model itself must be in External mode before communication between the model and the target program can begin. To enable External mode, select **External** from the **Simulation > Mode** menu.
- 7** Reopen the External Mode Control Panel (found in the **Code** menu) and click **Connect**. This initiates a handshake between Simulink and the target program. When Simulink and the target are connected, the **Start Real-Time Code** button becomes enabled, and the label of the **Connect** button changes to **Disconnect**.
- 8** Click the **Start Real-Time Code** button. The outputs of Gain blocks A and B are displayed on the two scopes in your model.

Having established communication between Simulink and the running target program, you can tune block parameters in Simulink and observe the effects the parameter changes have on the target program. You do this in the next section.

**Tune Parameters.** You can change the gain factor of either Gain block by assigning a new value to the variable A or B in the MATLAB workspace. When you change block parameter values in the workspace during a simulation, you must explicitly update the block diagram with these changes. When the block diagram is updated, the new values are downloaded to the target program.

To tune the variables A and B,

- 1 In the MATLAB Command Window, assign new values to both variables, for example:

```
A = 0.5;B = 3.5;
```

- 2 Activate the `extmode_example` model window. Select **Update Diagram** from the **Simulation** menu, or press **Ctrl+D**. As soon as Simulink has updated the block parameters, the new gain values are downloaded to the target program, and the effect of the gain change becomes visible on the scopes.
- 3 You can also enter gain values directly into the Gain blocks. To do this, open the Block Parameters dialog box for Gain block A or B in the model. Enter a new numerical value for the gain and click **Apply**. As soon as you click **Apply**, the new value is downloaded to the target program and the effect of the gain change becomes visible on the scope. Similarly, you can change the frequency, amplitude, or phase of the sine wave signal by opening the Block Parameters dialog box for the Sine Wave block and entering a new numerical value..

---

**Note** You cannot change the sample time of the Sine Wave block. Block sample times are part of the structural definition of the model and are part of the generated code. Therefore, if you want to change a block sample time, you must stop the External mode simulation, reset the block's sample time, and rebuild the executable.

---

- 4 To simultaneously disconnect host/target communication and end execution of the target program, pull down the **Simulation** menu and select **Stop Real-Time Code**. You can also do this from the External Mode Control Panel.

## Use the External Mode User Interface

- “External Mode Interface Options” on page 15-64
- “External Mode Related Menu and Toolbar Items” on page 15-66

- “External Mode Control Panel” on page 15-70
- “Target Interfacing” on page 15-73
- “External Signal Uploading and Triggering” on page 15-75
- “Data Archiving” on page 15-79
- “Parameter Downloading” on page 15-82

**External Mode Interface Options.** The ERT, GRT, GRT malloc, RSim, and Wind River Systems Tornado targets and the Real-Time Windows Target product support External mode. All targets that support it feature a set of External mode options on their respective target pane of the Configuration Parameters dialog box. This pane is normally named **Interface**). The next figure is the **Data exchange** section from the **Interface** pane of the GRT target dialog box, and is discussed below.

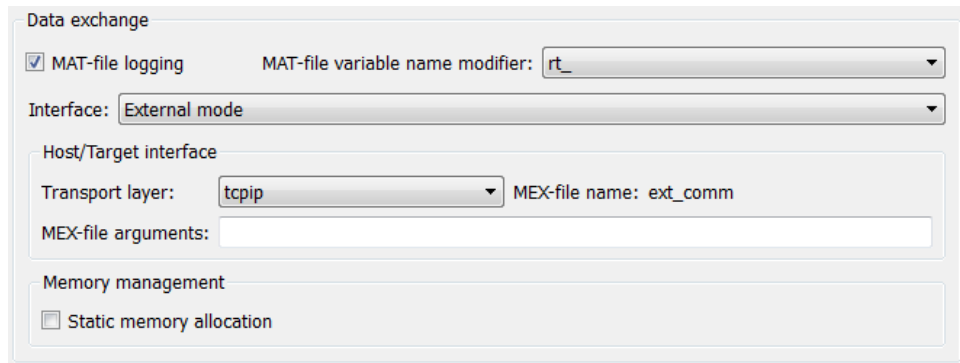

The screenshot shows the 'Data exchange' section of a configuration dialog. It includes a checked checkbox for 'MAT-file logging' and a dropdown for 'MAT-file variable name modifier' set to 'rt\_'. Below is an 'Interface' dropdown set to 'External mode'. A sub-section titled 'Host/Target interface' contains a 'Transport layer' dropdown set to 'tcpip' and a 'MEX-file name' text field with 'ext\_comm'. There is also an empty 'MEX-file arguments' text field. At the bottom, under 'Memory management', the 'Static memory allocation' checkbox is unchecked.

---

**Note** The xPC Target product also uses External mode communications. External mode in the xPC Target product is always on, and has no interface options.

---

The **Data exchange** section at the bottom of the **Interface** pane includes the following elements:

- **Interface** menu: Selects which of three mutually exclusive data interfaces to include in the generated code. Options are

- None
- C API
- External mode
- ASAP2

This chapter discusses only the `External mode` option. For information on other options, see “Specifying Target Interfaces” on page 9-58.

Once you select `External mode` from the `Interface` menu, the following options appear beneath:

- **Transport layer** menu: Identifies messaging protocol for host/target communications; choices are `tcpip` and `serial`.

The default is `tcpip`. When you select a protocol, the MEX-file name that implements the protocol is shown to the right of the menu.

- **MEX-file arguments** text field: Optionally enter a list of arguments to be passed to the transport layer MEX-file for communicating with executing targets; these will vary according to the protocol you use.

For more information on the transport options, see “Target Interfacing” on page 15-73 and “Choose Communication Protocol for Client and Server” on page 15-89. You can add other transport protocols yourself by following instructions given in “Create a Transport Layer for External Communication” on page 23-14.

- **Static memory allocation** check box: Controls how memory for External mode communication buffers in the target is allocated. When you select this option, the following one appears beneath it:
- **Static memory buffer size** text field: Number of bytes to preallocate for External mode communications buffers in the target when **Static memory allocation** is used.

---

**Note** Selecting `External mode` from the **Interface** menu does not cause the Simulink model to operate in External mode (see “External Mode Related Menu and Toolbar Items” on page 15-66, below). Its function is to instrument the code generated for the target to support External mode.

---

The **Static memory allocation** check box (for GRT and ERT targets) directs the Simulink Coder software to generate code for External mode that uses only static memory allocation (“malloc-free” code). When selected, it activates the **Static memory buffer size** edit field, in which you specify the size of the static memory buffer used by External mode. The default value is 1,000,000 bytes. Should you enter too small a value for your application, External mode issues an out-of-memory error when it tries to allocate more memory than you allowed. In such cases, increase the value in the **Static memory buffer size** field and regenerate the code.

---

### Notes

- To determine how much memory you need to allocate, enable verbose mode on the target (by including `OPTS="-DVERBOSE"` on the make command line). As it executes, External mode displays the amount of memory it tries to allocate and the amount of memory available to it each time it attempts an allocation. Should an allocation fail, this console log can be used to adjust the size entered in the **Static memory buffer size** field.
- When you create an ERT target, External mode can generate pure integer code. Select this feature by clearing the **Support floating-point numbers** option on the **Interface** pane of the Configuration Parameters dialog box or Model Explorer. Clearing this option makes the code, including External mode support code, free of doubles and floats. For more details, see “Code Generation Pane: Interface”.

---

**External Mode Related Menu and Toolbar Items.** To communicate with a target program, the model must be operating in External mode. To enable External mode, select **External** from the **Simulation > Mode** menu.

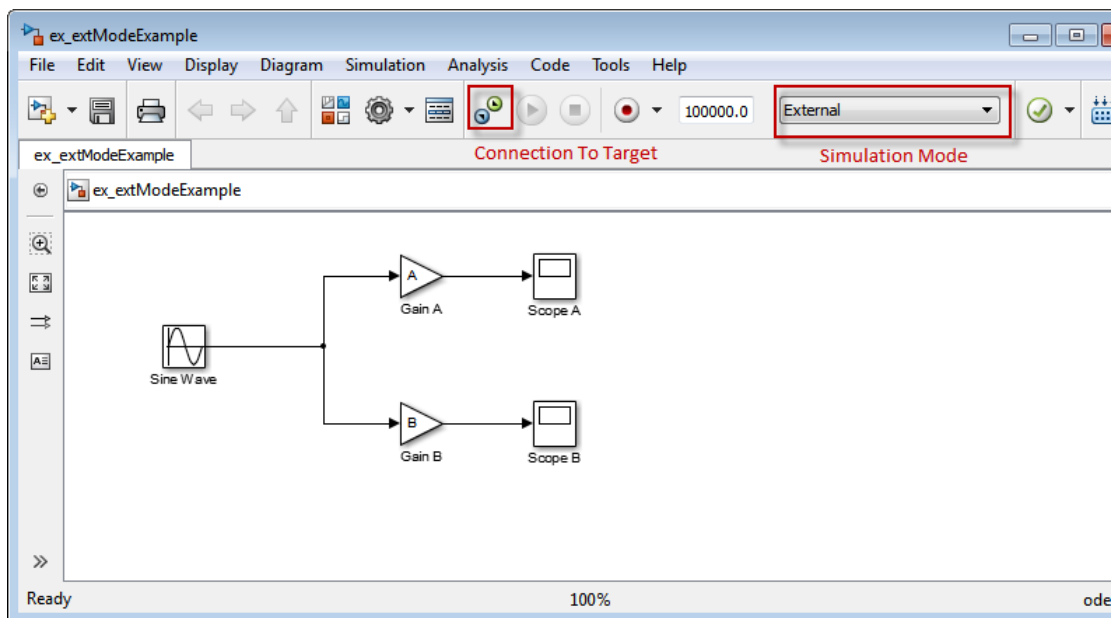

### Simulation Mode Menu Options and Target Connection Control (Host Disconnected from Target)

Once External mode is enabled, you can connect to and control the target program by doing any of the following:

- Select **Connect To Target** from the **Simulation** menu.
- Click the **Connect To Target** toolbar button.
- Use the **Ctrl+T** keyboard shortcut.

---

**Note** When External mode is selected in the model window, the **Ctrl+T** keyboard shortcut is remapped from a toggle for **Start** and **Stop** (simulation) to a toggle for **Connect To Target** and **Disconnect From Target**.

---

Selecting External mode in the model window controls execution only, and does *not* cause the Simulink Coder software to generate code for External mode. To do this, you must select External mode from the **Interface** menu

on the **Interface** tab of the Configuration Parameters dialog box, as described in “External Mode Interface Options” on page 15-64.

---

**Note** You can enable External mode, and simultaneously connect to the target system, by using the External Mode Control Panel dialog box. See “External Mode Control Panel” on page 15-70.

---

## Simulation Menu

When a Simulink model is in External mode, the upper section of the **Simulation** menu contains External mode options. Initially, the Simulink model is disconnected from the target program, and the menu displays the options shown in the next figure.

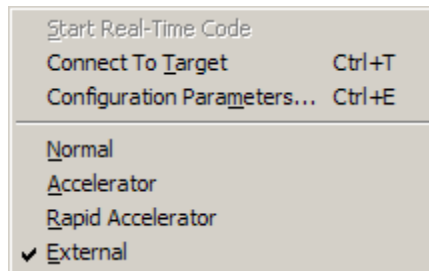

### Simulation Menu External Mode Options (Host Disconnected from Target)

The **Connect To Target** option establishes communication with the target program. When a connection is established, the target program might be executing model code, or it might be awaiting a command from the host to start executing model code. You can also accomplish this by clicking the **Connect To Target** toolbar button, as shown in Simulation Mode Menu Options and Target Connection Control (Host Disconnected from Target) on page 15-67.

If the target program is executing model code, the **Simulation** menu contents change, as shown in the next figure.



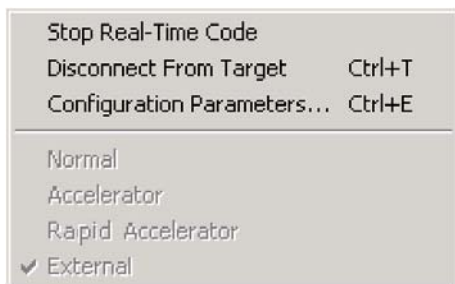

### Simulation Menu External Mode Options (Target Executing Model Code)

The **Disconnect From Target** option disconnects the Simulink model from the target program, which continues to run. The **Stop Real-Time Code** option terminates execution of the target program and disconnects the Simulink model from the target system.

If the target program is in a wait state, the **Start Real-Time Code** option is enabled, as shown in the next figure. The **Start Real-Time Code** option instructs the target program to begin executing the model code.

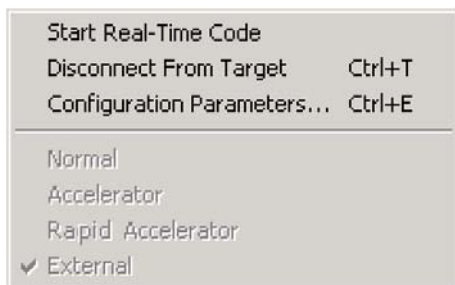

### Simulation Menu External Mode Options (Target Awaiting Start Command)

## Toolbar Controls

The Simulink toolbar controls, shown in Simulation Mode Menu Options and Target Connection Control (Host Disconnected from Target) on page 15-67, let you control the same External mode functions as the **Simulation** menu. The Simulink model editor displays External mode buttons to the left of the Simulation mode menu. Initially, the toolbar displays a **Connect To Target**

button and a disabled **Start Real-Time Code** button. Click the **Connect To Target** button to connect the Simulink engine to the target program.

When a connection is established, the target program might be executing model code, or it might be awaiting a command from the host to start executing model code.

If the target program is executing model code, the toolbar displays a **Stop Real-Time Code** button and a **Disconnect From Target** button (shown in ). Click the **Stop Real-Time Code** button to command the target program to stop executing model code and disconnect the Simulink engine from the target system. Click the **Disconnect From Target** button to disconnect the Simulink engine from the target program while leaving the target program running.

If the target program is in a wait state, the toolbar displays a **Start Real-Time Code** button and a **Disconnect From Target** button. Click the **Start Real-Time Code** button to instruct the target program to start executing model code. Click the **Disconnect From Target** button to disconnect the Simulink engine from the target program.

**External Mode Control Panel.** The External Mode Control Panel, illustrated in the next figure, provides centralized control of all External mode features, including

- Host/target connection, disconnection, and target program start/stop functions, and enabling of External mode
- Arming and disarming the data upload trigger
- External mode communications configuration
- Uploading data to Floating Scopes
- Timing of parameter downloads
- Selection of signals from the target program to be viewed and monitored on the host
- Configuration of data archiving features

Select **External Mode Control Panel** from the **Code** menu on the Simulink model editor to open the External Mode Control Panel dialog box.

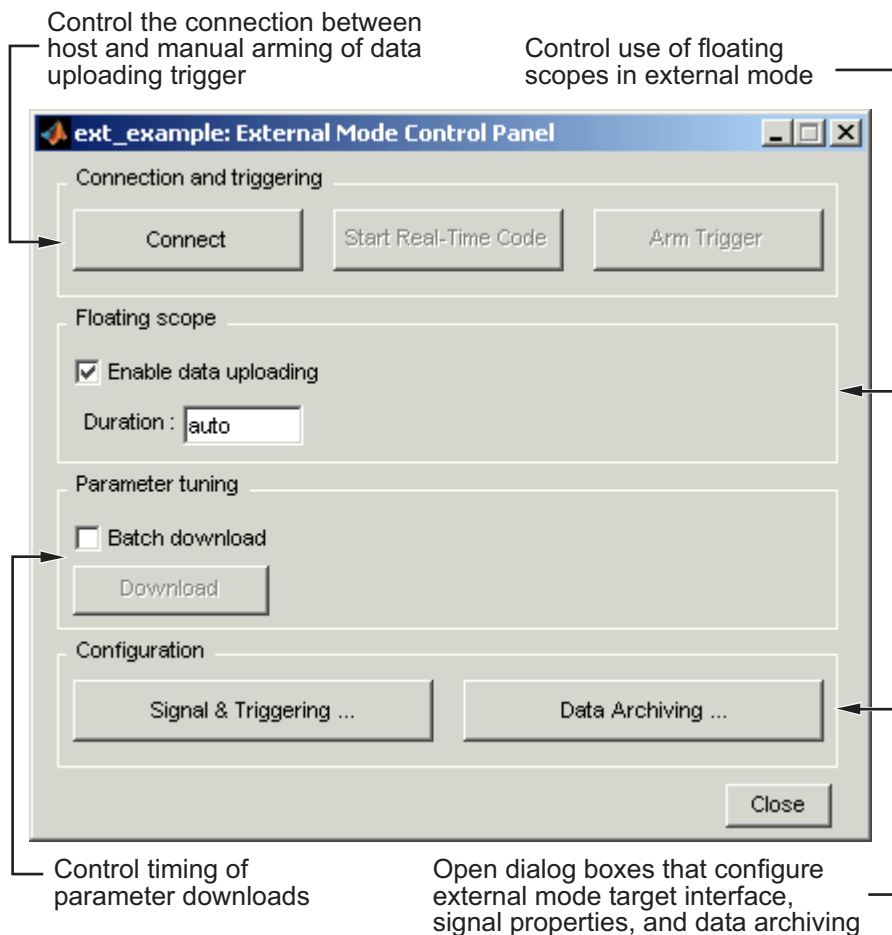

The following sections describe the features supported by the External Mode Control Panel.

### Connecting, Starting, and Stopping

The External Mode Control Panel performs the same connect/disconnect and start/stop functions found in the **Simulation** menu and the Simulink toolbar (see “External Mode Related Menu and Toolbar Items” on page 15-66).

The **Connect/Disconnect** button connects to or disconnects from the target program. The button text changes in accordance with the state of the connection.

If External mode is not enabled at the time the **Connect** button is clicked, the External Mode Control Panel enables External mode automatically.

The **Start/Stop Real-Time Code** button commands the target to start or terminate model code execution. The button is disabled until a connection to the target is established. The button text changes in accordance with the state of the target program.

### Floating Scope Options

The **Floating scope** pane of the External Mode Control Panel controls when and for how long data is uploaded to Floating Scope blocks. When used under External mode, Floating Scopes

- Do not appear in the signal and triggering GUI
- Support manual triggering only

The behavior of wired scopes is not restricted in these ways.

The **Floating scope** pane contains a check box and an edit field:

- **Enable data uploading** check box, which functions as an **Arm trigger** button for floating scopes. When the target is disconnected it controls whether or not to arm when connecting the floating scopes. When already connected it acts as a toggle button to arm/cancel the trigger.
- **Duration** edit field, which specifies the duration for floating scopes. By default, it is set to `auto`, which causes whatever value is specified in the signal and triggering GUI (which by default is 1000 base rate steps) to be used.

**Target Interfacing.** The Simulink Coder product lets you implement client and server transport for External mode using either TCP/IP or serial protocols. You can use the socket-based External mode implementation provided by the Simulink Coder product with the generated code, provided that your target system supports TCP/IP. Otherwise, use or customize the serial transport layer option provided.

A low-level *transport layer* handles physical transmission of messages. Both the Simulink engine and the model code are independent of this layer. Both the transport layer and code directly interfacing to the transport layer are isolated in separate modules that format, transmit, and receive messages and data packets.

You specify the transport mechanism using the **Transport layer** menu in the **Host/Target interface** subpane of the **Interface** pane of the Configuration Parameters dialog box, shown below.

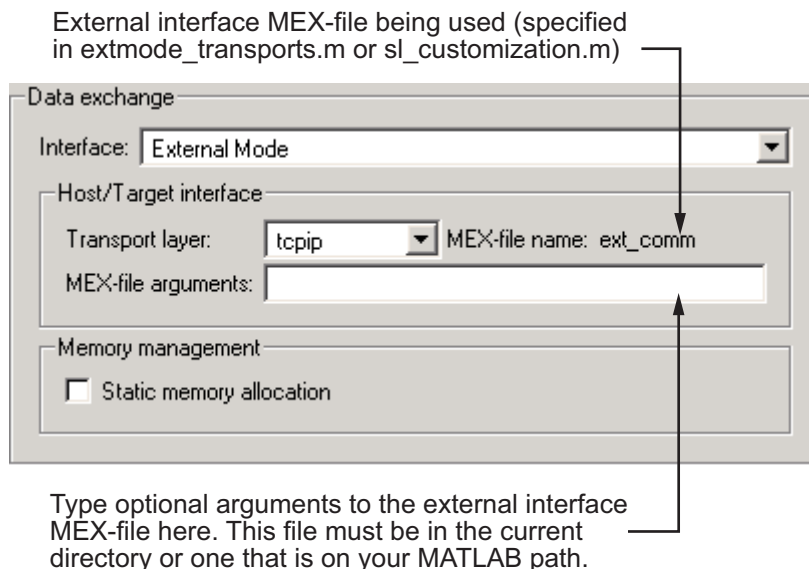

The **Host/Target interface** subpane also displays **MEX-file name**, the name of a MEX-file that implements host/target communications for the selected External mode transport layer. This is known as the external interface MEX-file. The default is `ext_comm`, the TCP/IP-based external

interface file provided for use with the GRT, GRT malloc, ERT, RSim, and Tornado targets. If you select the serial transport option, the MEX-file name `ext_serial_win32_com` is displayed in this location.

---

**Note** Custom or third-party targets can use a custom transport layer and a different external interface MEX-file. For more information on creating a custom transport layer, see “Create a Transport Layer for External Communication” on page 23-14. For more information on specifying a TCP/IP or serial transport layer for a custom target, see “Using the TCP/IP Implementation” on page 15-90 or “Using the Serial Implementation” on page 15-93.

---

The **MEX-file arguments** edit field lets you optionally specify arguments that are passed to the External mode interface MEX-file for communicating with executing targets. The meaning of the MEX-file arguments depends on the MEX-file implementation.

For TCP/IP interfaces, `ext_comm` allows three optional arguments:

- Network name of your target (for example, 'myPuter' or '148.27.151.12')
- Verbosity level (0 for no information or 1 for detailed information)
- TCP/IP server port number (an integer value between 256 and 65535, with a default of 17725)

For serial transport, `ext_serial_win32_comm` allows three optional arguments:

- Verbosity level (0 for no information or 1 for detailed information)
- Serial port ID (for example, 1 for COM1, and so on)
- Baud rate (selected from the set 1200, 2400, 4800, 9600, 14400, 19200, 38400, 57600, 115200, with a default baud rate of 57600)

See “Choose Communication Protocol for Client and Server” on page 15-89 for details on MEX-file transport architecture and arguments.

**External Signal Uploading and Triggering.** Clicking the **Signal & Triggering** button of the External Mode Control Panel activates the External Signal & Triggering dialog box, as shown in the next figure.

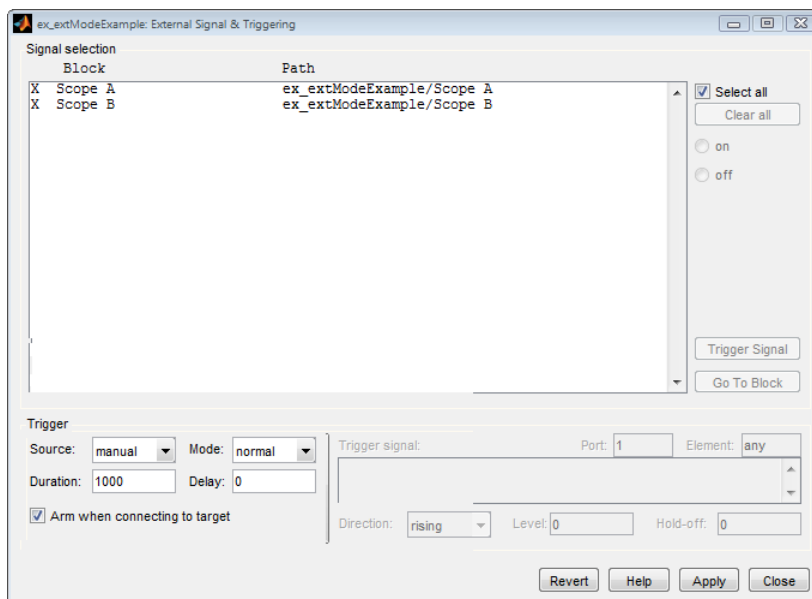

The External Signal & Triggering dialog box displays a list of all blocks and subsystems in your model that support External mode signal uploading. See “External Mode Compatible Blocks and Subsystems” on page 15-83 for information on which types of blocks are External mode compatible.

The External Signal & Triggering dialog box lets you select the signals that are collected from the target system and viewed in External mode. It also lets you select a signal that triggers uploading of data when certain signal conditions are met, and define the triggering conditions.

### Default Operation

The preceding figure shows the default settings of the External Signal & Triggering dialog box. The default operation of the External Signal & Triggering dialog box is designed to simplify monitoring the target program.

If you use the default settings, you do not need to preconfigure signals and triggers. Simply start the target program and connect the Simulink engine to it. All External mode compatible blocks will be selected and the trigger will be armed. Signal uploading begins immediately upon connection to the target program.

The default configuration is

- **Arm when connecting to target:** on
- **Trigger Mode:** normal
- **Trigger Source:** manual
- **Select all:** on

### Signal Selection

All External mode compatible blocks in your model appear in the **Signal selection** list of the External Signal & Triggering dialog box. You use this list to select signals to be viewed. An X appears to the left of each selected block's name.

The **Select all** check box selects all signals. By default, **Select all** is on.

If **Select all** is off, you can select or deselect individual signals using the **on** and **off** radio buttons. To select a signal, click the desired list entry and click the **on** radio button. To deselect a signal, click the desired list entry and click the **off** radio button. Alternatively, you can double-click a signal in the list to toggle between selection and deselection.

The **Clear all** button deselects all signals.

### Trigger Options

The **Trigger** panel located at the bottom left of the External Signal & Triggering dialog contains options that control when and how signal data is collected (uploaded) from the target system. These options are



- **Source:** manual or signal. Selecting manual directs External mode to start logging data when the **Arm trigger** button on the External Mode Control Panel is clicked.

Selecting signal tells External mode to start logging data when a selected trigger signal satisfies trigger conditions specified in the **Trigger signal** panel. When the trigger conditions are satisfied (that is, the signal crosses the trigger level in the specified direction) a *trigger event* occurs. If the trigger is *armed*, External mode monitors for the occurrence of a trigger event. When a trigger event occurs, data logging begins.

- **Arm when connecting to target:** If this option is selected, External mode arms the trigger automatically when the Simulink engine connects to the target. If the trigger source is manual, uploading begins immediately. If the trigger mode is signal, monitoring of the trigger signal begins immediately, and uploading begins upon the occurrence of a trigger event.

If **Arm when connecting to target** is not selected, you must manually arm the trigger by clicking the **Arm trigger** button in the External Mode Control Panel.

- **Duration:** The number of base rate steps for which External mode logs data after a trigger event (default is 1000). For example, if the fastest rate in the model is 1 second:
  - If a signal sampled at 1 Hz is logged for 10 base rate steps, External mode will collect 10 samples.
  - If a signal sampled at 2 Hz is logged for 10 base rate steps, External mode will collect 20 samples.
- **Mode:** normal or one-shot. In normal mode, External mode automatically rearms the trigger after each trigger event. In one-shot mode, External mode collects only one buffer of data each time you arm the trigger. See “Data Archiving” on page 15-79 for more details on the effect of the **Mode** setting.
- **Delay:** The delay represents the amount of time that elapses between a trigger occurrence and the start of data collection. The delay is expressed in base rate steps, and can be positive or negative (default is 0). A negative delay corresponds to pretriggering. When the delay is negative, data from the time preceding the trigger is collected and uploaded.

## Trigger Signal Selection

You can designate one signal as a trigger signal. To select a trigger signal, select **signal** from the **Trigger Source** menu. This activates the **Trigger signal** panel (see the next figure). Then, click the desired entry in the **Signal selection** list and click the **Trigger signal** button.

When a signal is selected as a trigger, a **T** appears to the left of the block's name in the **Signal selection** list. In the next figure, the **Scope A** signal is the trigger. **Scope B** is also selected for viewing, as indicated by the **X** to the left of the block name.

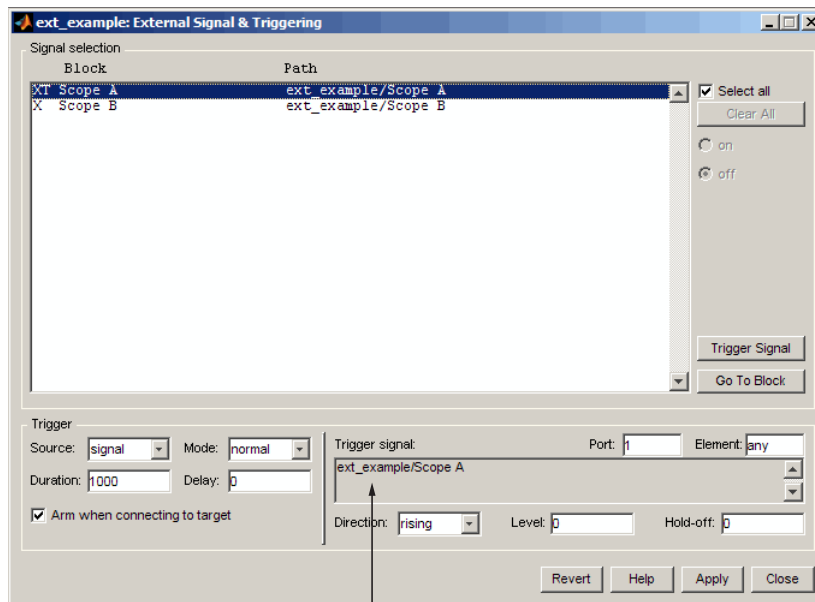

Trigger signal panel

## External Signal & Triggering Window with Trigger Selected

After selecting the trigger signal, you can define the trigger conditions and set the **Port** and **Element** fields in the **Trigger signal** panel.

---

## Setting Trigger Conditions

---

**Note** The **Trigger signal** panel and the **Port** and **Element** fields of the External Signal & Triggering dialog box are enabled only when trigger **Source** is set to **signal**.

---

By default, any element of the first input port of the specified trigger block can cause the trigger to fire (that is, Port 1, any element). You can modify this behavior by adjusting the **Port** and **Element** fields located on the right side of the Trigger signal panel. The **Port** field accepts a number or the keyword **last**. The **Element** field accepts a number or the keywords **any** and **last**.

The **Trigger Signal** panel defines the conditions under which a trigger event will occur.

- **Level:** Specifies a threshold value. The trigger signal must cross this value in a designated direction to fire the trigger. By default, the level is 0.
- **Direction:** **rising**, **falling**, or **either**. This specifies the direction in which the signal must be traveling when it crosses the threshold value. The default is **rising**.
- **Hold-off:** Applies only to **normal** mode. Expressed in base rate steps, **Hold-off** is the time between the termination of one trigger event and the rearming of the trigger.

**Data Archiving.** In External mode, you can use the Simulink Scope and To Workspace blocks to archive data to disk. Clicking the **Data Archiving** button of the External Mode Control Panel opens the External Data Archiving dialog box, which supports the following features.

### Folder Notes

Use this option to add annotations that pertain to a collection of related data files in a folder. Clicking the **Edit directory note** button opens the MATLAB editor. Place comments that you want saved to a file in the specified folder in this window. By default, the comments are saved to the folder last written to by data archiving.

## File Notes

Clicking **Edit file note** opens a file finder window that is, by default, set to the last file to which you have written. Selecting any MAT-file opens an edit window. Add or edit comments in this window that you want saved with your individual MAT-file.

## Automated Data Archiving

Clicking the **Enable Archiving** check box activates the automated data archiving features of External mode. To understand how the archiving features work, consider the handling of data when archiving is not enabled. There are two cases, one-shot and normal mode.

In one-shot mode, after a trigger event occurs, each selected block writes its data to the workspace just as it would at the end of a simulation. If another one-shot is triggered, the existing workspace data is overwritten.

In normal mode, External mode automatically rearms the trigger after each trigger event. Consequently, you can think of normal mode as a series of one-shots. Each one-shot in this series, except for the last, is referred to as an *intermediate result*. Since the trigger can fire at any time, writing intermediate results to the workspace generally results in unpredictable overwriting of the workspace variables. For this reason, the default behavior is to write only the results from the final one-shot to the workspace. The intermediate results are discarded. If you know that enough time exists between triggers for inspection of the intermediate results, then you can override the default behavior by checking the **Write intermediate results to workspace** check box. This option does not protect the workspace data from being overwritten by subsequent triggers.

The options in the External Data Archiving dialog box support automatic writing of logging results, including intermediate results, to disk. Data archiving provides the following settings:

- **Directory**: Specifies the folder in which data is saved. External mode appends a suffix if you select **Increment directory when trigger armed**.

- **File:** Specifies the filename in which data is saved. External mode appends a suffix if you select **Increment file after one-shot**.
- **Increment directory when trigger armed:** External mode uses a different folder for writing log files each time that you click the **Arm trigger** button. The folders are named incrementally, for example, `dirname1`, `dirname2`, and so on.
- **Increment file after one-shot:** New data buffers are saved in incremental files: `filename1`, `filename2`, and so on. This happens automatically in normal mode.
- **Append file suffix to variable names:** Whenever External mode increments filenames, each file contains variables with identical names. Selecting **Append file suffix to variable name** results in each file containing unique variable names. For example, External mode will save a variable named `xdata` in incremental files (`file_1`, `file_2`, and so on) as `xdata_1`, `xdata_2`, and so on. This is useful if you want to load the MAT-files into the workspace and compare variables at the MATLAB command prompt. Without the unique names, each instance of `xdata` would overwrite the previous one in the MATLAB workspace.
- **Write intermediate results to workspace:** Select this option if you want the Simulink Coder software to write all intermediate results to the workspace.

The next figure shows the External Data Archiving dialog box with archiving enabled.

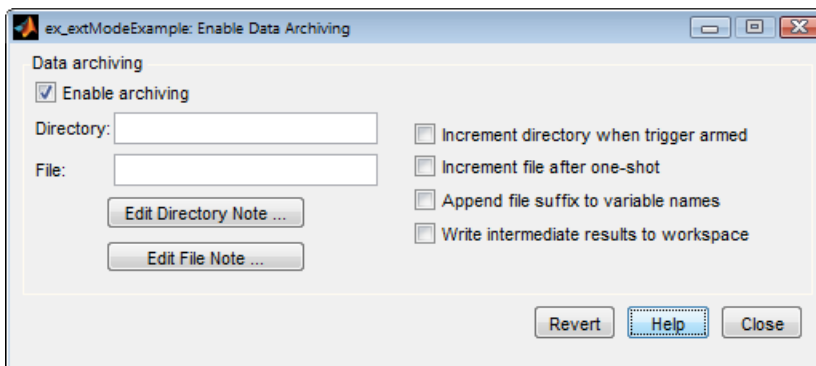

Unless you select **Enable archiving**, entries for the **Directory** and **File** fields are not accepted.

**Parameter Downloading.** The **Batch download** check box on the External Mode Control Panel enables or disables batch parameter changes.

By default, batch download is not enabled. If batch download is not enabled, changes made directly to block parameters by using parameter dialog boxes are sent to the target when you click the **OK** or **Apply** button. Changes to MATLAB workspace variables are sent when an Update diagram is performed.

If batch download is enabled, the Download button is enabled. Changes made to block parameters are stored locally until you click the Download button. When you click the Download button, the changes are sent in a single transmission.

When parameter changes have been made and are awaiting batch download, the External Mode Control Panel displays the message **Parameter changes pending...** to the right of the download button. (See the next figure.) This message disappears after the Simulink engine receives notification from the target that the new parameters have been installed in the parameter vector of the target system.

The External Mode Control Panel with the batch download option activated appears in the next figure.

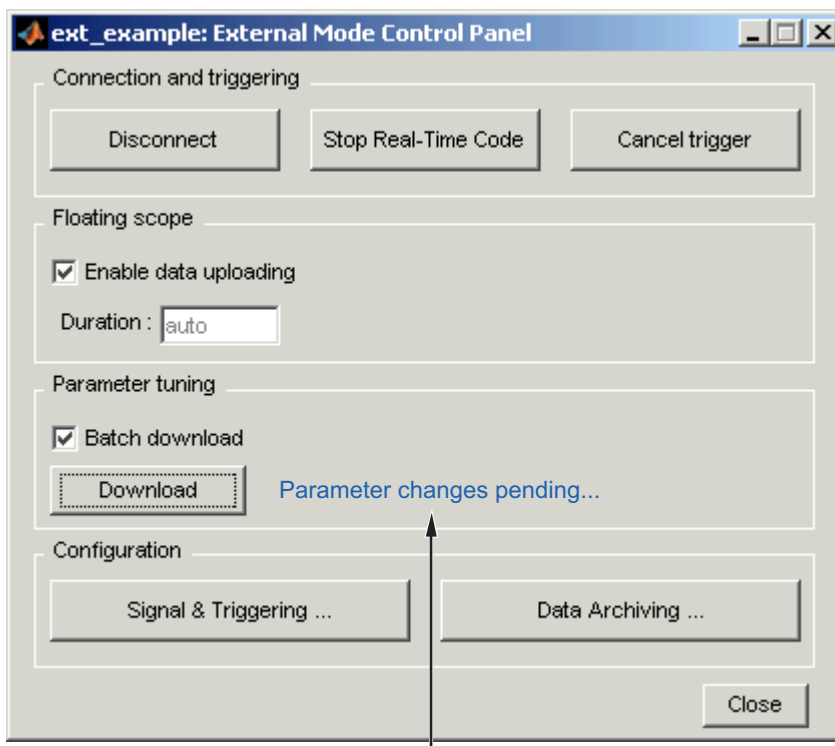

Parameter changes pending...  
message appears if unsent  
parameter value changes  
are awaiting download

### External Mode Control Panel in Batch Download Mode

### External Mode Compatible Blocks and Subsystems

- “Compatible Blocks” on page 15-83
- “Signal Viewing Subsystems” on page 15-84
- “Supported Blocks for Data Archiving” on page 15-86

**Compatible Blocks.** In External mode, you can use the following types of blocks to receive and view signals uploaded from the target program:

- Floating Scope and Scope blocks
- Spectrum Scope and Vector Scope blocks from the DSP System Toolbox product
- Blocks from the Gauges Blockset product
- Display blocks
- To Workspace blocks
- User-written S-Function blocks

An External mode method is built into the S-function API. This method allows user-written blocks to support External mode. See *matlabroot/simulink/simstruc.h*.

- XY Graph blocks

In addition to these types of blocks, you can designate certain subsystems as Signal Viewing Subsystems and use them to receive and view signals uploaded from the target program. See “Signal Viewing Subsystems” on page 15-84 for more information.

You select External mode compatible blocks and subsystems, and arm the trigger, by using the External Signal & Triggering dialog box. By default, all such blocks in a model are selected, and a manual trigger is set to be armed when connected to the target program.

**Signal Viewing Subsystems.** A Signal Viewing Subsystem is an atomic subsystem that encapsulates processing and viewing of signals received from the target system. A Signal Viewing Subsystem runs only on the host, generating no code in the target system. Signal Viewing Subsystems run in all simulation modes — normal, accelerated, and external.

Signal Viewing Subsystems are useful in situations where you want to process or condition signals before viewing or logging them, but you do not want to perform these tasks on the target system. By using a Signal Viewing Subsystem, you can generate smaller and more efficient code on the target system.

Like other External mode compatible blocks, Signal Viewing Subsystems are displayed in the External Signal & Triggering dialog box.



To declare a subsystem to be a Signal Viewing Subsystem,

- 1 Select the **Treat as atomic unit** option in the Block Parameters dialog box.

For more information on atomic subsystems, see “Code Generation of Subsystems” on page 2-2.

- 2 Use the following `set_param` command to turn the `SimViewingDevice` property on,

```
set_param('blockname', 'SimViewingDevice', 'on')
```

where 'blockname' is the name of the subsystem.

- 3 Make sure the subsystem meets the following requirements:

- It must be a pure sink block. That is, it must contain no Outport blocks or Data Store blocks. It can contain Goto blocks only if the corresponding From blocks are contained within the subsystem boundaries.
- It must have no continuous states.

The following model, `sink_examp`, contains an atomic subsystem, `theSink`.

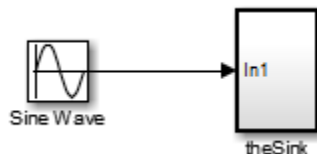

The subsystem `theSink`, shown in the next figure, applies a gain and an offset to its input signal and displays it on a Scope block.

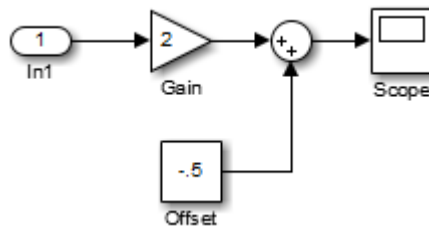

If `theSink` is declared as a Signal Viewing Subsystem, the generated target program includes only the code for the Sine Wave block. If `theSink` is selected and armed in the External Signal & Triggering dialog box, the target program uploads the sine wave signal to `theSink` during simulation. You can then modify the parameters of the blocks within `theSink` and observe their effect upon the uploaded signal.

If `theSink` were not declared as a Signal Viewing Subsystem, its Gain, Constant, and Sum blocks would run as subsystem code on the target system. The Sine Wave signal would be uploaded to the Simulink engine after being processed by these blocks, and viewed on `sink_examp/theSink/Scope2`. Processing demands on the target system would be increased by the additional signal processing, and by the downloading of changes in block parameters from the host.

**Supported Blocks for Data Archiving.** In External mode, you can use the following types of blocks to archive data to disk:

- Scope blocks
- To Workspace blocks

You configure data archiving by using the External Data Archiving dialog box, as described in “Data Archiving” on page 15-79.

## External Mode Communication

- “About External Mode Communication” on page 15-86
- “Download Mechanism” on page 15-87
- “Inlined and Tunable Parameters” on page 15-88

**About External Mode Communication.** This section describes how the Simulink engine and a target program communicate, and how and when they transmit parameter updates and signal data to each other.

Depending on the setting of the **Inline parameters** option when the target program is generated, there are differences in the way parameter updates are handled. “Download Mechanism” on page 15-87 describes the operation of External mode communications with **Inline parameters** off. “Inlined

and Tunable Parameters” on page 15-88 describes the operation of External mode with **Inline parameters** on.

**Download Mechanism.** In External mode, the Simulink engine does not simulate the system represented by the block diagram. By default, when External mode is enabled, the Simulink engine downloads all parameters to the target system. After the initial download, the engine remains in a waiting mode until you change parameters in the block diagram or until the engine receives data from the target.

When you change a parameter in the block diagram, the Simulink engine calls the external interface MEX-file, passing new parameter values (along with other information) as arguments. The external interface MEX-file contains code that implements one side of the interprocess communication (IPC) channel. This channel connects the Simulink process (where the MEX-file executes) to the process that is executing the external program. The MEX-file transfers the new parameter values by using this channel to the external program.

The other side of the communication channel is implemented within the external program. This side writes the new parameter values into the target’s parameter structure (*model\_P*).

The Simulink side initiates the parameter download operation by sending a message containing parameter information to the external program. In the terminology of client/server computing, the Simulink side is the client and the external program is the server. The two processes can be remote, or they can be local. Where the client and server are remote, a protocol such as TCP/IP is used to transfer data. Where the client and server are local, a serial connection or shared memory can be used to transfer data.

The next figure shows this relationship. The Simulink engine calls the external interface MEX-file whenever you change parameters in the block diagram. The MEX-file then downloads the parameters to the external program by using the communication channel.

Simulink Process

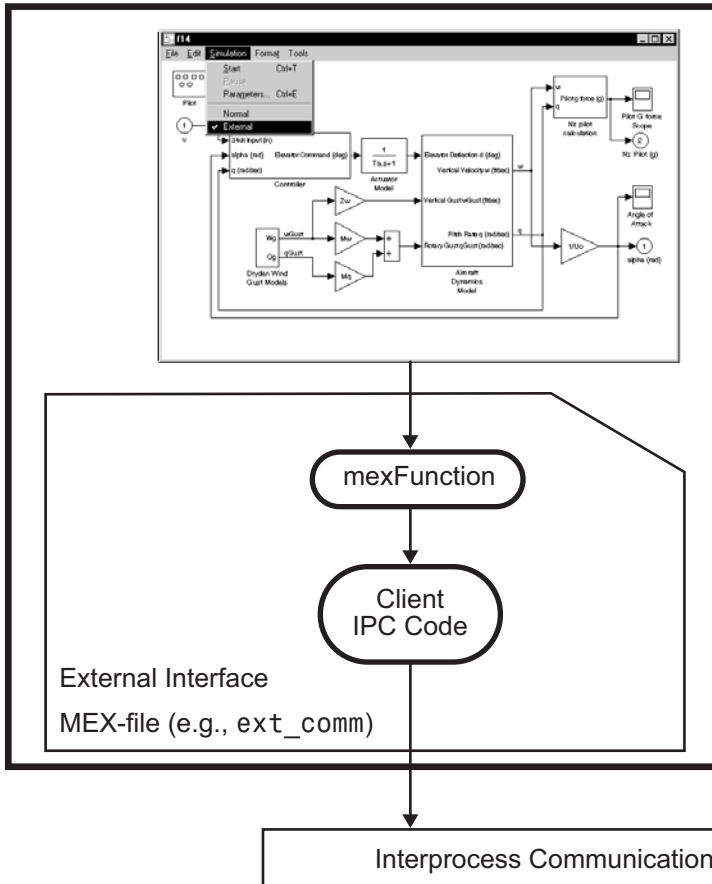

External Program Process

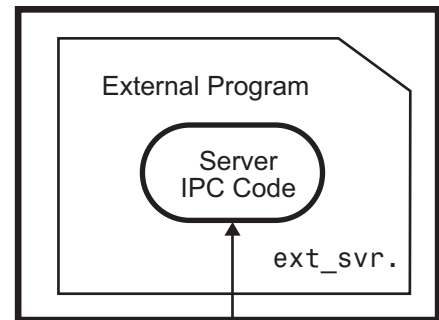

**External Mode Architecture**

**Inlined and Tunable Parameters.** By default, all parameters (except those listed in “External Mode Limitations” on page 15-103) in an External mode program are tunable; that is, you can change them by using the download mechanism described in this section.

If you select the **Inline parameters** option (on the **Optimization > Signals and Parameters** pane of the Configuration Parameters dialog box), the Simulink Coder code generator embeds the numerical values of model parameters (constants), instead of symbolic parameter names, in the

generated code. Inlining parameters generates smaller and more efficient code. However, inlined parameters, because they effectively become constants, are not tunable.

The Simulink Coder software lets you improve overall efficiency by inlining most parameters, while at the same time retaining the flexibility of run-time tuning for selected parameters that are important to your application. When you inline parameters, you can use the Model Parameter Configuration dialog box to remove individual parameters from inlining and declare them to be tunable. In addition, the Model Parameter Configuration dialog box offers you options for controlling how parameters are represented in the generated code.

For more information on tunable parameters, see “Parameters” on page 7-10.

## Automatic Parameter Uploading on Host/Target Connection

Each time the Simulink engine connects to a target program that was generated with **Inline parameters** on, the target program uploads the current value of its tunable parameters (if any) to the host. These values are assigned to the corresponding MATLAB workspace variables. This procedure synchronizes the host and target with respect to parameter values.

All workspace variables required by the model must be initialized at the time of host/target connection. Otherwise the uploading cannot proceed and an error results. Once the connection is made, these variables are updated to reflect the current parameter values on the target system.

Automatic parameter uploading takes place only if the target program was generated with **Inline parameters** on. “Download Mechanism” on page 15-87 describes the operation of External mode communications with **Inline parameters** off.

## Choose Communication Protocol for Client and Server

- “Introduction” on page 15-90
- “Using the TCP/IP Implementation” on page 15-90
- “Using the Serial Implementation” on page 15-93

- “Run the External Program” on page 15-95
- “Implement an External Mode Protocol Layer” on page 15-98

**Introduction.** The Simulink Coder product provides code to implement both the client and server side of External mode communication using either TCP/IP or serial protocols. You can use the socket-based External mode implementation provided by the Simulink Coder product with the generated code, provided that your target system supports TCP/IP. If not, use or customize the serial transport layer option provided.

A low-level *transport layer* handles physical transmission of messages. Both the Simulink engine and the model code are independent of this layer. Both the transport layer and code directly interfacing to the transport layer are isolated in separate modules that format, transmit, and receive messages and data packets.

See “Target Interfacing” on page 15-73 for information on selecting a transport layer.

**Using the TCP/IP Implementation.** You can use TCP/IP-based client/server implementation of External mode with real-time programs on The Open Group UNIX or PC systems. For help in customizing External mode transport layers, see “Create a Transport Layer for External Communication” on page 23-14.

To use Simulink External mode over TCP/IP, you must

- Make sure that the external interface MEX-file for your target’s TCP/IP transport is specified.

Targets provided by MathWorks specify the name of the external interface MEX-file in *matlabroot/toolbox/simulink/simulink/extmode\_transports.m*. The name of the interface appears as uneditable text in the **Host/Target interface** section of the **Interface** pane of the Configuration Parameters dialog box. The TCP/IP default is `ext_comm`.

To specify a TCP/IP transport for a custom target, you must add an entry of the following form to an `sl_customization.m` file on the MATLAB path:

```
function sl_customization(cm)
```

```
cm.ExtModeTransports.add('stf.tlc', 'transport', 'mexfile', 'Level1');
%end function
```

where

- *stf.tlc* is the name of the system target file for which the transport will be registered (for example, 'mytarget.tlc')
- *transport* is the transport name to display in the **Transport layer** menu on the **Interface** pane of the Configuration Parameters dialog box (for example, 'tcpip')
- *mexfile* is the name of the transport's associated external interface MEX-file (for example, 'ext\_comm')

You can specify multiple targets and/or transports with additional `cm.ExtModeTransports.add` lines, for example:

```
function sl_customization(cm)
    cm.ExtModeTransports.add('mytarget.tlc', 'tcpip', 'ext_comm', 'Level1');
    cm.ExtModeTransports.add('mytarget.tlc', 'serial', ...
                            'ext_serial_win32_comm', 'Level1');
%end function
```

- Be sure that the template makefile is configured to link the source files for the TCP/IP server code and that it defines the compiler flags when building the generated code.
- Build the external program.
- Run the external program.
- Set the Simulink model to External mode and connect to the target.

The next figure shows the structure of the TCP/IP-based implementation.

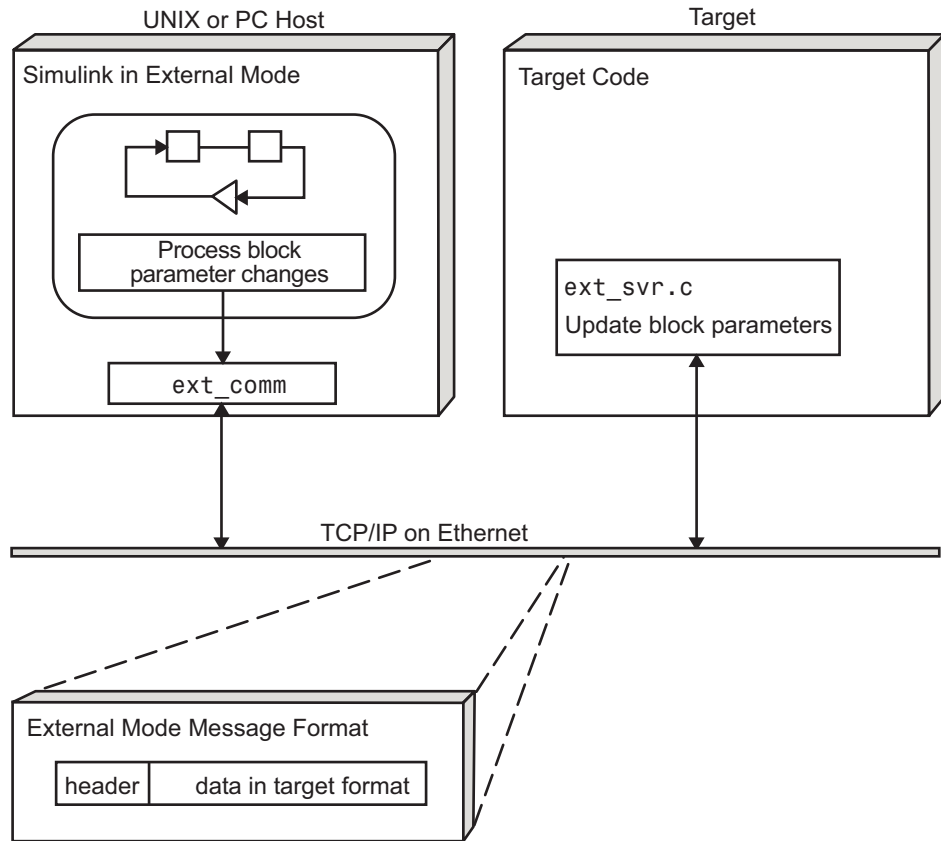

**TCP/IP-Based Client/Server Implementation for External Mode**

MEX-File Optional Arguments for TCP/IP Transport

In the External Target Interface dialog box, you can specify optional arguments that are passed to the External mode interface MEX-file for communicating with executing targets.

- Target network name: the network name of the computer running the external program. By default, this is the computer on which the Simulink product is running. The name can be
  - String delimited by single quotes, such as 'myPuter'



- IP address delimited by single quotes, such as '148.27.151.12'
- Verbosity level: controls the level of detail of the information displayed during the data transfer. The value is either 0 or 1 and has the following meaning:
  - 0 — No information
  - 1 — Detailed information
- TCP/IP server port number: The default value is 17725. You can change the port number to a value between 256 and 65535 to avoid a port conflict.

The arguments are positional and must be specified in order. For example, if you want to specify the verbosity level (the second argument), then you must also specify the target network name (the first argument). Arguments can be delimited by white space or commas. For example:

```
'148.27.151.12' 1 30000
```

You can specify command-line options to the external program when you launch it. See “Run the External Program” on page 15-95 for more information.

**Using the Serial Implementation.** Controlling host/target communications on a serial channel is similar to controlling host/target communications on a TCP/IP channel.

To use Simulink External mode over a serial channel, you must

- Execute the target and host on a Microsoft Windows platform.
- Make sure that the external interface MEX-file for your target’s serial transport is specified.

Targets provided by MathWorks specify the name of the external interface MEX-file in *matlabroot/toolbox/simulink/simulink/extmode\_transports.m*. The name of the interface appears as uneditable text in the **Host/Target interface** section of the **Interface** pane of the Configuration Parameters dialog box. The serial default is `serial`.

To specify a serial transport for a custom target, you must add an entry of the following form to an `sl_customization.m` file on the MATLAB path:

```
function sl_customization(cm)
    cm.ExtModeTransports.add('stf.tlc', 'transport', 'mexfile', 'Level1');
%end function
```

where

- `stf.tlc` is the name of the system target file for which the transport will be registered (for example, 'mytarget.tlc')
- `transport` is the transport name to display in the **Transport layer** menu on the **Interface** pane of the Configuration Parameters dialog box (for example, 'serial')
- `mexfile` is the name of the transport's associated external interface MEX-file (for example, 'ext\_serial\_win32\_comm')

You can specify multiple targets and/or transports with additional `cm.ExtModeTransports.add` lines, for example:

```
function sl_customization(cm)
    cm.ExtModeTransports.add('mytarget.tlc', 'tcpip', 'ext_comm', 'Level1');
    cm.ExtModeTransports.add('mytarget.tlc', 'serial', ...
                             'ext_serial_win32_comm', 'Level1');
%end function
```

- Be sure that the template makefile is configured to link the source files for the serial server code and that it defines the compiler flags when building the generated code.
- Build the external program.
- Run the external program.
- Set the Simulink model to External mode and connect to the target.

### MEX-File Optional Arguments for Serial Transport

In the **MEX-file arguments** field of the **Interface** pane of the Configuration Parameters dialog box, you can specify arguments that are passed to the External mode interface MEX-file for communicating with the executing targets. For serial transport, the optional arguments to `ext_serial_win32_comm` are

- Verbose level: controls the level of detail of the information displayed during the data transfer. The value is either 0 or 1 and has the following meaning:

0 — No information  
1 — Detailed information

- Serial port ID (for example, 1 for COM1, and so on)

If the target program is executing on the same machine as the host and communications is through a loopback serial cable, the target's port ID must differ from that of the host (as specified in the **MEX-file arguments** edit field).

When you start the target program using a serial connection, you must specify the port ID to use to connect it to the host. Do this by including the `-port` command-line option. For example,

```
mytarget.exe -port 2 -w
```

- Baud rate (selected from the set 1200, 2400, 4800, 9600, 14400, 19200, 38400, 57600, 115200, with a default baud rate of 57600)

The arguments are positional and must be specified in order. For example, if you want to specify the serial port ID (the second argument), then you must also specify the verbose level (the first argument). Arguments can be delimited by white space or commas. For example:

```
1 1 115200
```

You can specify command-line options to the external program when you launch it. The following section provides details on using command-line arguments.

**Run the External Program.** The external program must be running before you can use the Simulink product in External mode. To run the external program, you type a command of the form

```
model -opt1 ... -optN
```

where *model* is the name of the external program and `-opt1 ... -optN` are options. (See Command-Line Options for the External Program on page

97.) In the examples in this section, the name of the external program is assumed to be `ext_example`.

### Running the External Program Under the Windows Environment

In the Windows environment, you can run the external programs in either of the following ways:

- Open a Command Prompt window. At the command prompt, type the name of the target executable, followed by any options, as in the following example:

```
ext_example -tf inf -w
```

- Alternatively, you can launch the target executable from the MATLAB command prompt. In this case the command must be preceded by an exclamation point (!) and followed by an ampersand (&), as in the following example:

```
!ext_example -tf inf -w &
```

The ampersand (&) causes the operating system to spawn another process to run the target executable. If you do not include the ampersand, the program still runs, but you will be unable to enter commands at the MATLAB command prompt or manually terminate the executable.

### Running the External Program Under the UNIX Environment

In the UNIX environment, you can run the external programs in either of the following ways:

- Open an Xterm window. At the command prompt, type the name of the target executable, followed by any options, as in the following example:

```
ext_example -tf inf -w
```

- Alternatively, you can launch the target executable from the MATLAB command prompt. In the UNIX environment, if you start the external

program from the MATLAB command prompt, you must run it in the background so that you can still access the Simulink environment. The command must be preceded by an exclamation point (!) and followed by an ampersand (&), as in the following example:

```
!ext_example -tf inf -w &
```

runs the executable from the MATLAB command prompt by spawning another process to run it.

## Command-Line Options for the External Program

External mode target executables generated by the Simulink Coder code generator support the following command-line options:

- `-tf n` option

The `-tf` option overrides the stop time set in the Simulink model. The argument `n` specifies the number of seconds the program will run. The value `inf` directs the model to run indefinitely. In this case, the model code will run until the target program receives a stop message from the Simulink engine.

The following example sets the stop time to 10 seconds.

```
ext_example -tf 10
```

When integer-only ERT targets are built and executed in External mode, the stop time parameter (`-tf`) is interpreted by the target as the number of base rate ticks rather than the number of seconds to execute.

---

**Note** The `-tf` option works with GRT, GRT malloc, ERT, RSim, and Tornado targets. If you are creating a custom target and want to support the `-tf` option, you must implement the option yourself. See “Create a Transport Layer for External Communication” on page 23-14 for more information.

---

- `-w` option: Instructs the target program to enter a wait state until it receives a message from the host. At this point, the target is running, but

not executing the model code. The start message is sent when you select **Start Real-Time Code** from the **Simulation** menu or click the **Start Real-Time Code** button in the External Mode Control Panel.

Use the `-w` option if you want to view data from time step 0 of the target program execution, or if you want to modify parameters before the target program begins execution of model code.

- `-port n` option: Specifies the TCP/IP port number, `n`, for the target program. The port number of the target program must match that of the host. The default port number is 17725. The port number must be a value between 256 and 65535.

---

**Note** The `-tf`, `-w`, and `-port` options are supported by the TCP/IP and serial transport layer modules shipped with the Simulink Coder product (although `-port` is interpreted differently by each). The `-baud` option is serial only. By default, these modules are linked into External mode target executables. If you are implementing a custom External mode transport layer and want to support these options, you must implement them in your code.

---

**Implement an External Mode Protocol Layer.** If you want to implement your own transport layer for External mode communication, you must modify certain code modules provided by the Simulink Coder product and create a new external interface MEX-file. This advanced topic is described in detail in “Create a Transport Layer for External Communication” on page 23-14.

### **Use External Mode Programmatically**

You can run external-mode applications from the MATLAB command line or programmatically in scripts. Use the `get_param` and `set_param` commands to retrieve and set the values of model simulation command-line parameters, such as `SimulationMode` and `SimulationCommand`, and External mode command-line parameters, such as `ExtModeCommand` and `ExtModeTrigType`. (For more information on using `get_param` and `set_param` to tune model parameters, see “Tune Parameters” on page 7-36.)

The following sequence of model simulation commands assumes that a Simulink model is open and that you have loaded a target program to which the model will connect using External mode.

- 1 Change the Simulink model to External mode:

```
set_param(gcs, 'SimulationMode', 'external')
```

- 2 Connect the open model to the loaded target program:

```
set_param(gcs, 'SimulationCommand', 'connect')
```

- 3 Start running the target program:

```
set_param(gcs, 'SimulationCommand', 'start')
```

- 4 Stop running the target program:

```
set_param(gcs, 'SimulationCommand', 'stop')
```

- 5 Disconnect the target program from the model:

```
set_param(gcs, 'SimulationCommand', 'disconnect')
```

The next table lists External mode command-line parameters that you can use in `get_param` and `set_param` commands. The table provides brief descriptions, valid values (bold type highlights defaults), and a mapping to External Mode dialog box equivalents.

---

**Note** For External mode parameters that are equivalent to **Interface** pane options in the Configuration Parameters dialog box, see the `ExtMode` table entries in “Parameter Command-Line Information Summary”.

---

### External Mode Command-Line Parameters

Parameter and Values	Dialog Box Equivalent	Description
ExtModeAddSuffixToVar <b>off</b> , on	External Data Archiving: <b>Append file suffix to variable names</b> check box	Increment variable names for each incremented filename.
ExtModeArchiveDirName <i>string</i>	External Data Archiving: <b>Directory</b> text field	Save data in specified folder.
ExtModeArchiveFileName <i>string</i>	External Data Archiving: <b>File</b> text field	Save data in specified file.
ExtModeArchiveMode <i>string</i> - <b>off</b> , on	External Data Archiving: <b>Enable archiving</b> check box	Activate automated data archiving features.
ExtModeArmWhenConnect <b>off</b> , <b>on</b>	External Signal & Triggering: <b>Arm when connecting to target</b> check box	Arm the trigger as soon as the Simulink Coder software connects to the target.
ExtModeAutoIncOneShot <b>off</b> , on	External Data Archiving: <b>Increment file after one-shot</b> check box	Save new data buffers in incremental files.
ExtModeAutoUpdateStatusClock (Microsoft Windows platforms only) <b>off</b> , <b>on</b>	Not available	Continuously upload and display target time on the model window status bar.
ExtModeBatchMode <b>off</b> , on	External Mode Control Panel: <b>Batch download</b> check box	Enable or disable downloading of parameters in batch mode.
ExtModeChangesPending <b>off</b> , on	Not available	When ExtModeBatchMode is enabled, indicates whether any parameters remain in the queue of parameters to be downloaded to the target.
ExtModeCommand <i>string</i>	Not available	Issue an External mode command to the target program.



**External Mode Command-Line Parameters (Continued)**

<b>Parameter and Values</b>	<b>Dialog Box Equivalent</b>	<b>Description</b>
ExtModeConnected <b>off, on</b>	External Mode Control Panel: <b>Connect/Disconnect</b> button	Indicate the state of the connection with the target program.
ExtModeEnableFloating <b>off, on</b>	External Mode Control Panel: <b>Enable data uploading</b> check box	Enable or disable the arming and canceling of triggers when a connection is established with floating scopes.
ExtModeIncDirWhenArm <b>off, on</b>	External Data Archiving: <b>Increment directory when trigger armed</b> check box	Write log files to incremental folders each time the trigger is armed.
ExtModeLogAll <b>off, on</b>	External Signal & Triggering: <b>Select all</b> check box	Upload all available signals from the target to the host.
ExtModeLogCtrlPanelDlg <i>string</i>	Not available	Return a handle to the External Mode Control Panel dialog box or -1 if the dialog box does not exist.
ExtModeParamChangesPending <b>off, on</b>	Not available	When the Simulink Coder software is connected to the target and ExtModeBatchMode is enabled, indicates whether any parameters remain in the queue of parameters to be downloaded to the target. More efficient than ExtModeChangesPending, because it checks for a connection to the target.

**External Mode Command-Line Parameters (Continued)**

<b>Parameter and Values</b>	<b>Dialog Box Equivalent</b>	<b>Description</b>
ExtModeSkipDownloadWhenConnect <b>off</b> , on	Not available	Connect to the target program without downloading parameters.
ExtModeTrigDelay <i>integer</i> ( <b>0</b> )	External Signal & Triggering: <b>Delay</b> text field	Specify the amount of time (expressed in base rate steps) that elapses between a trigger occurrence and the start of data collection.
ExtModeTrigDirection <i>string</i> - <b>rising</b> , falling, either	External Signal & Triggering: <b>Direction</b> menu	Specify the direction in which the signal must be traveling when it crosses the threshold value.
ExtModeTrigDuration <i>integer</i> ( <b>1000</b> )	External Signal & Triggering: <b>Duration</b> text field	Specify the number of base rate steps for which External mode is to log data after a trigger event.
ExtModeTrigDurationFloating <i>string</i> - <i>integer</i> ( <b>auto</b> )	External Mode Control Panel: <b>Duration</b> text field	Specify the duration for floating scopes. If auto is specified, the value of ExtModeTrigDuration is used.
ExtModeTrigElement <i>string</i> - <i>integer</i> , <b>any</b> , last	External Signal & Triggering: <b>Element</b> text field	Specify the elements of the input port of the specified trigger block that can cause the trigger to fire.
ExtModeTrigHoldOff <i>integer</i> ( <b>0</b> )	External Signal & Triggering: <b>Hold-off</b> text field	Specify the base rate steps between when a trigger event terminates and the trigger is rearmed.
ExtModeTrigLevel <i>integer</i> ( <b>0</b> )	External Signal & Triggering: <b>Level</b> text field	Specify the threshold value the trigger signal must cross to fire the trigger.

## External Mode Command-Line Parameters (Continued)

Parameter and Values	Dialog Box Equivalent	Description
ExtModeTrigMode <i>string</i> - <b>normal</b> , oneshot	External Signal & Triggering: <b>Mode</b> menu	Specify whether the trigger is to rearm automatically after each trigger event or whether only one buffer of data is to be collected each time the trigger is armed.
ExtModeTrigPort <i>string</i> - <i>integer</i> ( <b>1</b> ), last	External Signal & Triggering: <b>Port</b> text field	Specify the input port of the specified trigger block for which elements can cause the trigger to fire.
ExtModeTrigType <i>string</i> - <b>manual</b> , signal	External Signal & Triggering: <b>Source</b> menu	Specify whether to start logging data when the trigger is armed or when a specified trigger signal satisfies trigger conditions.
ExtModeUploadStatus <i>string</i> - inactive, armed, uploading	Not available	Return the status of the External mode upload mechanism — inactive, armed, or uploading.
ExtModeWriteAllDataToWs <b>off</b> , on	External Data Archiving: <b>Write intermediate results to workspace</b> check box	Write all intermediate results to the workspace.

## External Mode Limitations

- “Limitation on Changing Parameters” on page 15-104
- “Limitation on Mixing 32-bit and 64-bit Architectures” on page 15-105
- “Limitation on Uploading Data” on page 15-105
- “Limitation on Uploading Variable-Size Signals” on page 15-105
- “Limitation on Archiving Data” on page 15-105

- “Limitation on Scopes in Referenced Models” on page 15-105

**Limitation on Changing Parameters.** In general, you cannot change a parameter if doing so results in a change in the structure of the model. For example, you cannot change

- The number of states, inputs, or outputs of any block
- The sample time or the number of sample times
- The integration algorithm for continuous systems
- The name of the model or of any block
- The parameters to the Fcn block

If you cause any of these changes to the block diagram, then you must rebuild the program with newly generated code.

However, you can change parameters in transfer function and state space representation blocks in specific ways:

- The parameters (numerator and denominator polynomials) for the Transfer Fcn (continuous and discrete) and Discrete Filter blocks can be changed (as long as the number of states does not change).
- Zero entries in the State-Space and Zero Pole (both continuous and discrete) blocks in the user-specified or computed parameters (that is, the A, B, C, and D matrices obtained by a zero-pole to state-space transformation) cannot be changed once external simulation is started.
- In the State-Space block, if you specify the matrices in the controllable canonical realization, then all changes to the A, B, C, D matrices that preserve this realization and the dimensions of the matrices are allowed.

If the Simulink block diagram does not match the external program, the Simulink engine displays an error informing you that the checksums do not match (that is, the model has changed since you generated code). This means that you must rebuild the program from the new block diagram (or reload another one) to use External mode.

If the external program is not running, the Simulink engine displays an error informing you that it cannot connect to the external program.

**Limitation on Mixing 32-bit and 64-bit Architectures.** When you use External mode, the machine running the Simulink product and the machine running the target executable must have matching bit architectures, either 32-bit or 64-bit. This is because the Simulink Coder software varies a model's checksum based on whether it is configured for a 32-bit or 64-bit platform.

If you attempt to connect from a 32-bit machine to a 64-bit machine or vice versa, the External mode connection fails.

**Limitation on Uploading Data.** External mode does not support uploading data values for fixed-point or enumerated types into workspace parameters.

**Limitation on Uploading Variable-Size Signals.** External mode does not support uploading variable-size signals for the following targets:

- xPC Target
- Texas Instruments C2000™

**Limitation on Archiving Data.** External mode supports the Scope and To Workspace blocks for archiving data to disk. However, External mode does not support scopes other than the Scope block for archiving data. For example, you cannot use Floating Scope blocks or Signal and Scope Manager viewer objects to archive data in External mode.

**Limitation on Scopes in Referenced Models.** In a model hierarchy, if the top model simulates in External mode and a referenced model simulates in Normal or Accelerator mode, scopes in the referenced model do not display.

However, if the top model is changed to simulate in Normal mode, the behavior of scopes in the referenced models differs between Normal and Accelerator mode. Scopes in a referenced model simulating in Normal mode display, while scopes in a referenced model simulating in Accelerator mode do not display.

## Logging

- “Log Data for Analysis” on page 15-106
- “About Logging to MAT-Files” on page 15-115
- “Configure State, Time, and Output Logging” on page 15-116

- “Log Data with Scope and To Workspace Blocks” on page 15-117
- “Log Data with To File Blocks” on page 15-118
- “Data Logging Differences Between Single- and Multitasking” on page 15-118

## **Log Data for Analysis**

- “About Logging Data” on page 15-106
- “Data Logging During Simulation” on page 15-107
- “Data Logging from Generated Code” on page 15-111

**About Logging Data.** Simulink Coder MAT-file data logging facility enables a generated program to save system states, outputs, and simulation time at each model execution time step. The data is written to a MAT-file, named (by default) *model.mat*, where *model* is the name of your model. In this example, data generated by the model *rtwdemo\_f14* is logged to the file *rtwdemo\_f14.mat*. Refer to “Build a Generic Real-Time Program” on page 15-14 for instructions on setting up *rtwdemo\_f14* in a working folder if you have not done so already.

To configure data logging, click **Data Import/Export** in the center pane of the Model Explorer. The process is the same as configuring a Simulink model to save output to the MATLAB workspace. For each workspace return variable you define and enable, the Simulink Coder software defines a parallel MAT-file variable. For example, if you save simulation time to the variable *tout*, your generated program logs the same data to a variable named *rt\_tout*. You can change the prefix *rt\_* to a suffix (*\_rt*), or eliminate it entirely. You do this by selecting **Code Generation** in the center pane of the Model Explorer, then clicking the **Interface** tab.

---

**Note** Simulink lets you log signal data from anywhere in a model via the **Log signal data** option in the Signal Properties dialog box (accessed via context menu by right-clicking signal lines). The Simulink Coder software does not use this method of signal logging in generated code. To log signals in generated code, you must either use the **Data Import/Export** options described below or include To File or To Workspace blocks in your model.

---

In this example, you modify the `rtwdemo_f14` model so that the generated program saves the simulation time and system outputs to the file `rtwdemo_f14.mat`. Then you load the data into the MATLAB workspace and plot simulation time against one of the outputs. The `rtwdemo_f14` model should be open and configured as described in “Build a Generic Real-Time Program” on page 15-14.

**Data Logging During Simulation.** To use the data logging feature:

- 1** Open Model Explorer by selecting **Model Explorer** from the model’s **View** menu.
- 2** In the **Model Hierarchy** pane, click the + sign preceding the model name to reveal its components.
- 3** Click **Configuration (Active)** in the left pane.
- 4** Click **Data Import/Export** in the center pane. The **Data Import/Export** pane, which appears at the right, lets you specify which output data is to be saved to the workspace and what variable names to use for it.
- 5** Select the **Time** option. This tells Simulink to save time step data during simulation as a variable named `tout`. You can enter a different name to distinguish different simulation runs (for example using different step sizes), but take the default for this example. Selecting **Time** enables the Simulink Coder code generator to create code that logs the simulation time to a MAT-file.
- 6** Select the **Output** option. This tells Simulink to save output signal data during simulation as a variable named `yout`. Selecting **Output** enables the Simulink Coder code generator to create code that logs the root Output blocks (Angle of Attack and Pilot G Force) to a MAT-file.

---

**Note** The sort order of the `yout` array is based on the port number of the Output blocks, starting with 1. Angle of Attack and Pilot G Force are logged to `yout(:,1)` and `yout(:,2)`, respectively.

---



- 7 If any other options are enabled, clear them. Set **Decimation** to 1 and **Format** to Array. The figure below shows the dialog.

**Data Import/Export**

Load from workspace

Input:

Initial state:

Save to workspace

Time, State, Output

Time:  Format:

States:   Limit data points to last:

Output:  Decimation:

Final states:   Save complete SimState in final state

Signals

Signal logging:  Signal logging format:

Data Store Memory

Data stores:

Save options

Output options:  Refine factor:

Return as single object:

Inspect signal logs when simulation is paused/stopped

- 8 Click **Apply** to register your changes.
- 9 Save the model.
- 10 Open the Pilot G Force Scope block of the model, then run the model by choosing **Simulation > Run** in the model window. The resulting Pilot G Force scope display is shown below.

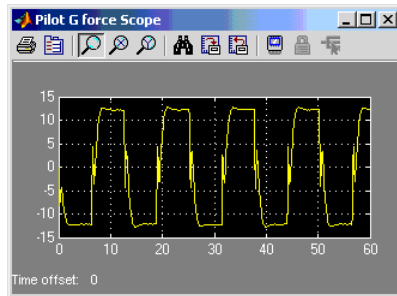

- 11 Verify that the simulation time and outputs have been saved to the MATLAB workspace in MAT-files. At the MATLAB prompt, type:

```
whos *out
```

Simulink displays:

Name	Size	Bytes	Class	Attributes
tout	601x1	4808	double	
yout	601x2	9616	double	

- 12** Verify that Pilot G Force was logged by plotting simulation time versus that variable. At the MATLAB prompt, type:

```
plot(tout,yout(:,2))
```

The resulting plot is shown below.

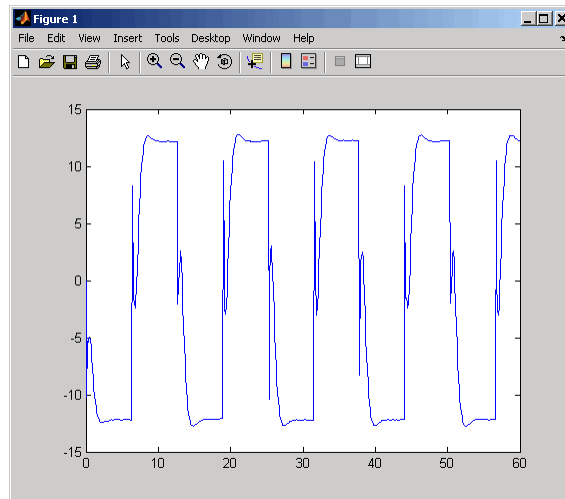

**Data Logging from Generated Code.** In the second part of this example, you build and run a Simulink Coder executable of the `rtwdemo_f14` model that outputs a MAT-file containing the simulation time and outputs you previously examined. Even though you have already generated code for the `rtwdemo_f14` model, you must now regenerate that code because you have changed the model by enabling data logging. The steps below explain this procedure.

To avoid overwriting workspace data with data from simulation runs, the Simulink Coder code generator modifies identifiers for variables logged by Simulink. You can control these modifications from the **Model Explorer**:

- 1** Open Model Explorer by selecting **Model Explorer** from the model's **View** menu.
- 2** In the **Model Hierarchy** pane, click the + sign preceding the model name to reveal its components.

- 3** Click **Configuration (Active)** in the left pane.
- 4** In the center pane, click **Code Generation**. The **Code Generation** pane appears to the right.
- 5** Click the **Interface** tab.
- 6** Set **MAT-file variable name modifier** to `_rt`. This adds the suffix `_rt` to each variable that you selected to be logged in the first part of this example (tout, yout).

- 7 Clear the **Generate code only** check box, if it is currently selected. The pane should look like this:

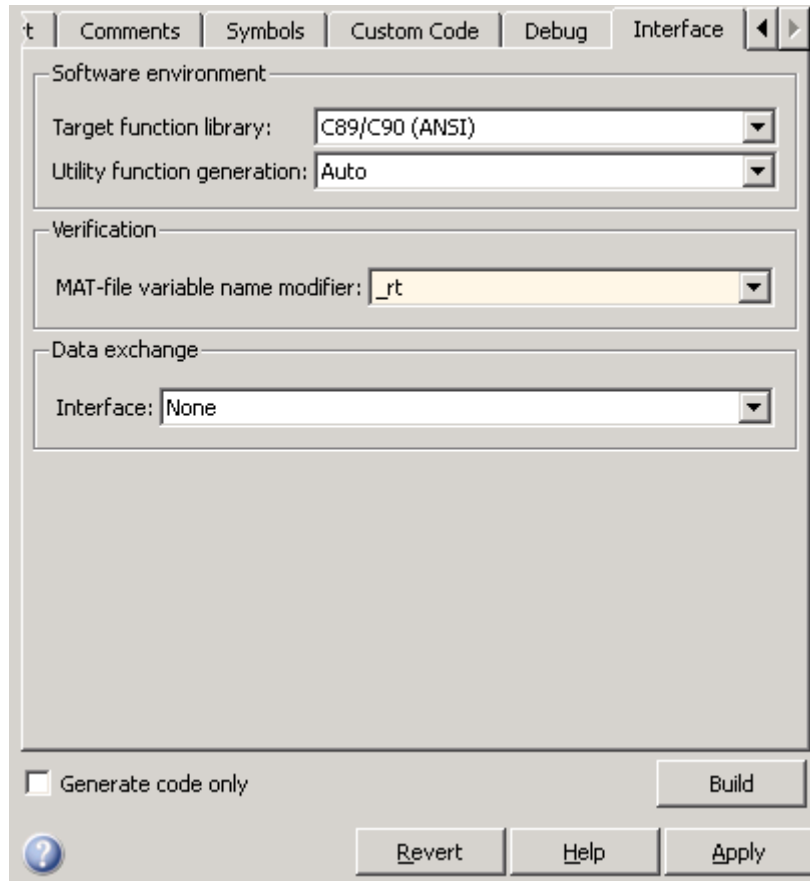

- 8 Click **Apply** to register your changes.
- 9 Save the model.
- 10 To generate code and build an executable, click the **Build** button.
- 11 When the build concludes, run the executable with the command:

```
!rtwdemo_f14
```

- 12** The program now produces two message lines, indicating that the MAT-file has been written.

```
** starting the model **  
** created rtwdemo_f14.mat **
```

- 13** Load the MAT-file data created by the executable and look at the workspace variables from simulation and the generated program by typing:

```
load rtwdemo_f14.mat  
whos tout* yout*
```

Simulink displays:

Name	Size	Bytes	Class	Attribute
tout	601x1	4808	double	
tout_rt	601x1	4808	double	
yout	601x2	9616	double	
yout_rt	601x2	9616	double	

Note that all arrays have the same number of elements.

- 14** Observe that the variables `tout_rt` (time) and `yout_rt` (Pilot G Force and Angle of Attack) have been loaded from the file. Plot Pilot G Force as a function of time.

```
plot(tout_rt,yout_rt(:,2))
```

The resulting plot is identical to the plot you produced in step 10 of the previous part of this example:

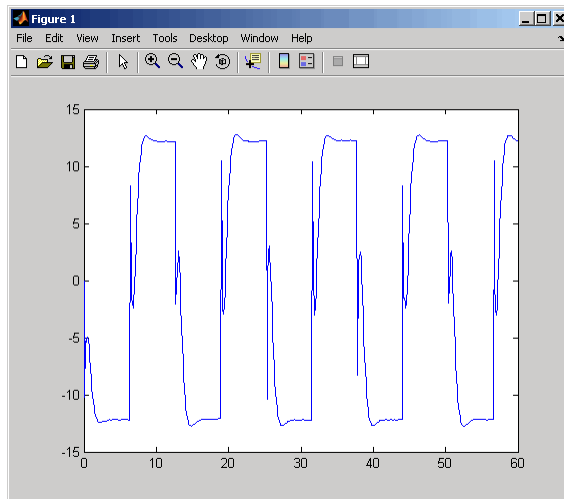

### About Logging to MAT-Files

Multiple techniques are available by which a program generated by the Simulink Coder software can save data to a MAT-file for analysis. See also “Log Data for Analysis” on page 15-106 for a data logging tutorial.

---

**Note** Data logging is available only for targets that have access to a file system. In addition, only the RSim target executables are capable of accessing MATLAB workspace data.

---

## Configure State, Time, and Output Logging

The Data Import/Export pane enables a generated program to save system states, outputs, and simulation time at each model execution time step. The data is written to a MAT-file, named (by default) *model.mat*.

Before using this data logging feature, you should learn how to configure a Simulink model to return output to the MATLAB workspace. This is discussed in “Export Simulation Data”.

For each workspace return variable that you define and enable, the code generator defines a MAT-file variable. For example, if your model saves simulation time to the workspace variable `tout`, your generated program logs the same data to a variable named (by default) `rt_tout`.

The code generated by the code generator logs the following data:

- All root Output blocks

The default MAT-file variable name for system outputs is `rt_yout`.

The sort order of the `rt_yout` array is based on the port number of the Output block, starting with 1.

- All continuous and discrete states in the model

The default MAT-file variable name for system states is `rt_xout`.

- Simulation time

The default MAT-file variable name for simulation time is `rt_tout`.

- “Override the Default MAT-File Name” on page 15-116
- “Override the Default MAT-File Variable Names” on page 15-117
- “Override the Default MAT-File Buffer Size” on page 15-117

**Override the Default MAT-File Name.** The MAT-file name defaults to *model.mat*. To specify a different file name,

**1** In the model window, select **Simulation > Model Configuration Parameters**. The dialog box opens.

**2** Click **Code Generation**.



- 3 Append the following option to the existing text in the **Make command** field:

```
OPTS=" -DSAVEFILE=filename"
```

**Override the Default MAT-File Variable Names.** By default, the code generation software prefixes the string `rt_` to the variable names for system outputs, states, and simulation time to form MAT-file variable names. To change this prefix,

- 1 In the model window, select **Simulation > Model Configuration Parameters**. The dialog box opens.
- 2 Click **Code Generation**.
- 3 Select `grt.tlc` for **System target file**.
- 4 Select **Code Generation > Interface**
- 5 Select a prefix (`rt_`) or suffix (`_rt`) from the **MAT-file variable name modifier** field, or choose `none` for no prefix (other targets may or may not have this option).

**Override the Default MAT-File Buffer Size.** The size of the buffer for MAT-file data logging defaults to 1024 bytes. To specify a different buffer size,

- 1 In the model window, select **Simulation > Model Configuration Parameters**. The dialog box opens.
- 2 Click **Code Generation**.
- 3 Append the following option to the existing text in the **Make command** field:

```
OPTS=" -DDEFAULT_BUFFER_SIZE=n"
```

where *n* specifies a buffer size in bytes.

## Log Data with Scope and To Workspace Blocks

The code generated by the code generator also logs data from these sources:

- All Scope blocks that have the Save data to workspace parameter enabled  
You must specify the variable name and data format in each Scope block's dialog box.
- All To Workspace blocks in the model  
You must specify the variable name and data format in each To Workspace block's dialog box.

The variables are written to `model.mat`, along with any variables logged from the Workspace I/O pane.

### Log Data with To File Blocks

You can also log data to a To File block. The generated program creates a separate MAT-file (distinct from `model.mat`) for each To File block in the model. The file contains the block's time and input variable(s). You must specify the filename, variable names, decimation, and sample time in the To File block's dialog box.

---

**Note** Models referenced by Model blocks do not perform data logging in that context except for states, which you can include in the state logged for top models. Code generated by the Simulink Coder software for referenced models does not perform data logging to MAT-files.

---

### Data Logging Differences Between Single- and Multitasking

When logging data in single-tasking and multitasking systems, you will notice differences in the logging of

- Noncontinuous root Output blocks
- Discrete states

In multitasking mode, the logging of states and outputs is done after the first task execution (and not at the end of the first time step). In single-tasking mode, the code generated by the build procedure logs states and outputs after the first time step.

See Data Logging in Single-Tasking and Multitasking Model Execution for more details on the differences between single-tasking and multitasking data logging.

---

**Note** The rapid simulation target (RSim) provides enhanced logging options. See “Rapid Simulations” on page 12-2 for more information.

---

## Parameter Tuning

- “Tunable Parameter Storage” on page 15-119
- “Tunable Parameter Storage Classes” on page 15-121
- “Declare Tunable Parameters” on page 15-124
- “Tunable Expressions” on page 15-128
- “Linear Block Parameter Tunability” on page 15-132
- “Tunable Workspace Parameter Data Type Considerations” on page 15-133
- “Tune Parameters from the Command Line” on page 15-135
- “Interfaces for Tuning Parameters” on page 15-137

## Tunable Parameter Storage

A *tunable* parameter is a block parameter whose value can be changed at run-time. A tunable parameter is inherently noninlined. Consequently, when **Inlined parameters** is off, all parameters are members of *model\_P*, and thus are tunable. A *tunable expression* is an expression that contains one or more tunable parameters.

When you declare a parameter tunable, you control whether or not the parameter is stored within *model\_P*. You also control the symbolic name of the parameter in the generated code.

When you declare a parameter tunable, you specify

- The *storage class* of the parameter.

The storage class property of a parameter specifies how the Simulink Coder product declares the parameter in generated code.

The term “storage class,” as used in the Simulink Coder product, is not synonymous with the term *storage class specifier*, as used in the C language.

- A *storage type qualifier*, such as `const` or `volatile`. This is simply a string that is included in the variable declaration.
- (Implicitly) the symbolic name of the variable or field in which the parameter is stored. The Simulink Coder product derives variable and field names from the names of tunable parameters.

The Simulink Coder product generates a variable or `struct` storage declaration for each tunable parameter. Your choice of storage class controls whether the parameter is declared as a member of `model_P` or as a separate global variable.

You can use the generated storage declaration to make the variable visible to external legacy code. You can also make variables declared in your code visible to the generated code. You are responsible for linking your code to generated code modules.

You can use tunable parameters or expressions in your root model and in masked or unmasked subsystems, subject to certain restrictions. (See “Tunable Expressions” on page 15-128.)

**Override Inlined Parameters for Tuning.** When the **Inline parameters** option is selected, you can use the Model Parameter Configuration dialog box to remove individual parameters from inlining and declare them to be tunable. This allows you to improve overall efficiency by inlining most parameters, while at the same time retaining the flexibility of run-time tuning for selected parameters. Another way you can achieve the same result is by using Simulink data objects; see “Parameters” on page 7-10 for specific details.

The mechanics of declaring tunable parameters are discussed in “Declare Tunable Parameters” on page 15-124.

## Tunable Parameter Storage Classes

The Simulink Coder product defines four storage classes for tunable parameters. You must declare a tunable parameter to have one of the following storage classes:

- **SimulinkGlobal (Auto):** This is the default storage class. The Simulink Coder product stores the parameter as a member of *model\_P*. Each member of *model\_P* is initialized to the value of the corresponding workspace variable at code generation time.
- **ExportedGlobal:** The generated code instantiates and initializes the parameter and *model.h* exports it as a global variable. An exported global variable is independent of the *model\_P* data structure. Each exported global variable is initialized to the value of the corresponding workspace variable at code generation time.
- **ImportedExtern:** *model\_private.h* declares the parameter as an extern variable. Your code must supply the variable definition and initializer.
- **ImportedExternPointer:** *model\_private.h* declares the variable as an extern pointer. Your code must supply the pointer variable definition and initializer, if any.

The generated code for *model.h* includes *model\_private.h* to make the extern declarations available to subsystem files.

As an example of how the storage class declaration affects the code generated for a parameter, consider the next figure.

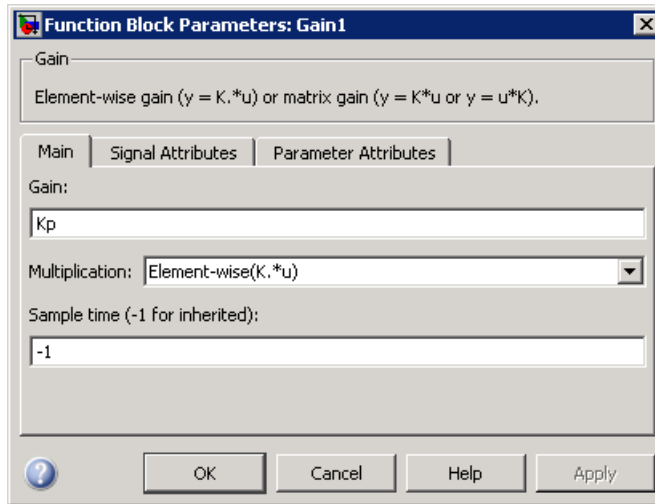

The workspace variable `Kp` sets the gain of the `Gain1` block. Assume that the value of `Kp` is 3.14. The following table shows the variable declarations and the code generated for the gain block when `Kp` is declared as a tunable parameter. An example is shown for each storage class.

---

**Note** The Simulink Coder product uses column-major ordering for two-dimensional signal and parameter data. When interfacing your hand-written code to such signals or parameters by using `ExportedGlobal`, `ImportedExtern`, or `ImportedExternPointer` declarations, make sure that your code observes this ordering convention.

---

The symbolic name `Kp` is preserved in the variable and field names in the generated code.

Storage Class	Generated Variable Declaration and Code
SimulinkGlobal (Auto)	<pre> typedef struct _Parameters_tunable_sin Parameters_tunable_sin;  struct _Parameters_tunable_sin {     real_T Kp; };  Parameters_tunable_sin tunable_sin_P = {     3.14 }; . . tunable_sin_Y.Out1 = rtb_u * tunable_sin_P.Kp; </pre>
ExportedGlobal	<pre> real_T Kp = 3.14; . . tunable_sin_Y.Out1 = rtb_u * Kp; </pre>
ImportedExtern	<pre> extern real_T Kp; . . tunable_sin_Y.Out1 = rtb_u * Kp; </pre>
ImportedExtern Pointer	<pre> extern real_T *Kp; . . tunable_sin_Y.Out1 = rtb_u * (*Kp); </pre>

## Declare Tunable Parameters

- “Declare Workspace Variables as Tunable Parameters” on page 15-124
- “Declare New Tunable Parameters” on page 15-124
- “Declare Tunable Parameters Using Configuration Parameter Dialog” on page 15-125
- “Select Workspace Variables” on page 15-126
- “Create New Tunable Parameters” on page 15-127
- “Set Tunable Parameter Properties” on page 15-128
- “Remove Unused Tunable Parameters” on page 15-128

**Declare Workspace Variables as Tunable Parameters.** To declare tunable parameters,

- 1** Open the Model Parameter Configuration dialog box.
- 2** In the **Source list** pane, select one or more variables.
- 3** Click **Add to table** . The variables then appear as tunable parameters in the **Global (tunable) parameters** pane.
- 4** Select a parameter in the **Global (tunable) parameters** pane.
- 5** Select a storage class from the **Storage class** menu.
- 6** Optionally, select (or enter) a storage type qualifier, such as `const` or `volatile` for the parameter.
- 7** Click **Apply**, or click **OK** to apply changes and close the dialog box.

**Declare New Tunable Parameters.** To declare tunable parameters,

- 1** Open the Model Parameter Configuration dialog box.
- 2** In the **Global (tunable) parameters** pane, click **New**.
- 3** Specify a name for the parameter.



- 4** Select a storage class from the **Storage class** menu.
- 5** Optionally, select (or enter) a storage type qualifier, such as `const` or `volatile` for the parameter.
- 6** Click **Apply**, or click **OK** to apply changes and close the dialog box.

### **Declare Tunable Parameters Using Configuration Parameter Dialog.**

The Model Parameter Configuration dialog box lets you select base workspace variables and declare them to be tunable parameters in the current model. Using controls in the dialog box, you move variables from a source list to a global (tunable) parameter list for a model.

To open the dialog box,

- 1** Select the **Inline parameters** check box on the **Optimization > Signals and Parameters** pane of the Configuration Parameters dialog box. This activates a **Configure** button, as shown below.

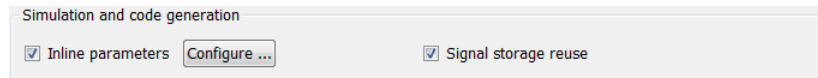

- 2** Click **Configure** to open the Model Configuration Parameter dialog box.

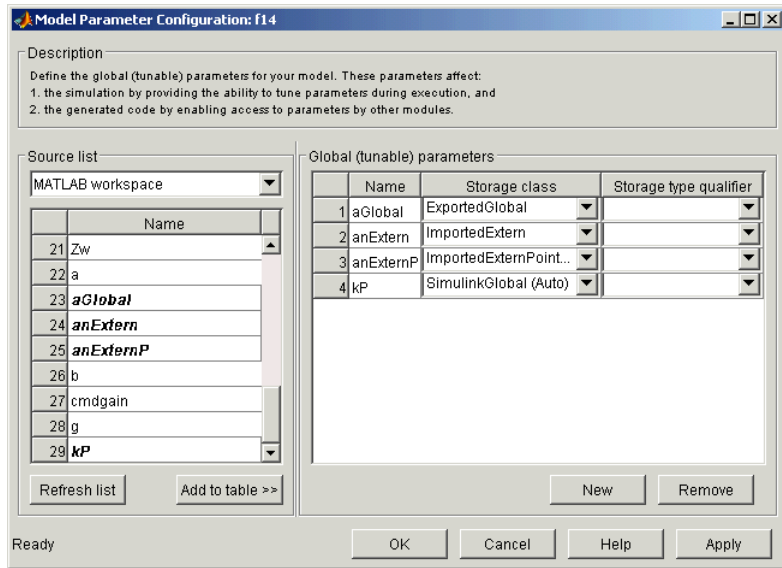

**Note** The Model Configuration Parameter dialog box cannot tune parameters within referenced models. See “Parameterize Model References” for tuning techniques that work with referenced models.

**Select Workspace Variables.** The **Source list** pane displays a menu and a scrolling table of numerical workspace variables. To select workspace variables,

- 1 From the menu, select the source of variables you want listed.

To List...	Choose...
All variables in the MATLAB workspace that have numeric values	MATLAB workspace
Only variables in the MATLAB workspace that have numeric values and are referenced by the model	Referenced workspace variables

A list of workspace variables appear in the **Source List** pane.

- 2** Select one or more variables from the source list. This enables the **Add to table** button.
- 3** Click **Add to table** to add the selected variables to the tunable parameters list in the **Global (tunable) parameters** pane. In the **Source list**, the names of variables added to the tunable parameters list are displayed in bold type (see the preceding figure).

---

**Note** If you selected a variable with a name that matches a block parameter that is not tunable and you click **Add to table** , a warning appears during simulation and code generation.

---

To update the list of variables to reflect the current state of the workspace, at any time, click **Refresh list** . For example, you might use **Refresh list** if you define or remove variables in the workspace while the Model Parameter Configuration dialog box is open.

**Create New Tunable Parameters.** To create a new tunable parameter,

- 1** In the **Global (tunable) parameters** pane, click **New**.
- 2** In the **Name** field, enter a name for the parameter.

If you enter a name that matches the name of a workspace variable in the **Source list** pane, that variable is declared tunable and appears in italics in the **Source list**.

- 3** Click **Apply**.

The model does not need to be using a parameter before you create it. You can add references to the parameter later.

---

**Note** If you edit the name of an existing variable in the list, you actually create a new tunable variable with the new name. The previous variable is removed from the list and loses its tunability (that is, it is inlined).

---

**Set Tunable Parameter Properties.** To set the properties of tunable parameters listed in the **Global (tunable) parameters** pane, select a parameter and then specify a storage class and, optionally, a storage type qualifier.

Property	Description
<b>Storage class</b>	Select one of the following to be used for code generation: <ul style="list-style-type: none"> <li>• SimulinkGlobal (Auto)</li> <li>• ExportedGlobal</li> <li>• ImportedExtern</li> <li>• ImportedExternPointer</li> </ul> See “Tunable Parameter Storage Classes” on page 15-121 for definitions.
<b>Storage type qualifier</b>	For variables with any storage class <i>except</i> SimulinkGlobal (Auto), you can add a qualifier (such as <code>const</code> or <code>volatile</code> ) to the generated storage declaration. To do so, you can select a predefined qualifier from the list or add qualifiers not in the list. The code generator does not check the storage type qualifier for validity, and includes the qualifier string in the generated code without checking syntax .

**Remove Unused Tunable Parameters.** To remove unused tunable parameters from the table in the **Global (tunable) parameters** pane, click **Remove**. All removed variables are inlined if the **Inlined parameters** option is enabled.

### Tunable Expressions

- “Tunable Expressions in Masked Subsystems” on page 15-129
- “Tunable Expression Limitations” on page 15-131

The Simulink Coder product supports the use of tunable variables in expressions. An expression that contains one or more tunable parameters is called a *tunable expression*.

**Tunable Expressions in Masked Subsystems.** Tunable expressions are allowed in masked subsystems. You can use tunable parameter names or tunable expressions in a masked subsystem dialog box. When referenced in lower-level subsystems, such parameters remain tunable.

As an example, consider the masked subsystem in the next figure. The masked variable *k* sets the gain parameter of *theGain*.



Suppose that the base workspace variable *b* is declared tunable with `SimulinkGlobal (Auto)` storage class. The next figure shows the tunable expression  $b*3$  in the subsystem's mask dialog box.

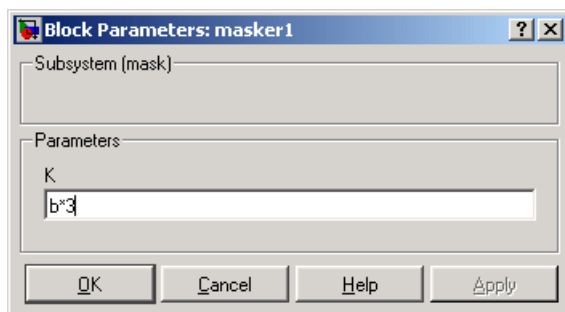

### Tunable Expression in Subsystem Mask Dialog Box

The Simulink Coder product produces the following output computation for *theGain*. The variable *b* is represented as a member of the global parameters structure, *model\_P*. (For clarity in showing the individual Gain block computation, expression folding is off in this example.)

```
/* Gain: '<S1>/theGain' */
```

```
rtb_theGain_C = rtb_SineWave_n * ((subsys_mask_P.b * 3.0));

/* Output: '<Root>/Out1' */
subsys_mask_Y.Out1 = rtb_theGain_C;
```

As this example shows, for GRT targets, the parameter structure is mangled to create the structure identifier *model\_P* (subject to the identifier length constraint). This is done to avoid namespace clashes in combining code from multiple models using model reference. ERT-based targets provide ways to customize identifier names.

When expression folding is on, the above code condenses to

```
/* Output: '<Root>/Out1' incorporates:
 * Gain: '<S1>/theGain'
 */
subsys_mask_Y.Out1 = rtb_SineWave_n * ((subsys_mask_P.b * 3.0));
```

Expressions that include variables that were declared or modified in mask initialization code are *not* tunable.

As an example, consider the subsystem above, modified as follows:

- The mask initialization code is  
 $t = 3 * k;$
- The parameter *k* of the *myGain* block is  $4 + t$ .
- Workspace variable  $b = 2$ . The expression  $b * 3$  is plugged into the mask dialog box as in the preceding figure.

Since the mask initialization code can run only once, *k* is evaluated at code generation time as

$$4 + (3 * (2 * 3))$$

The Simulink Coder product inlines the result. Therefore, despite the fact that *b* was declared tunable, the code generator produces the following output computation for *theGain*. (For clarity in showing the individual Gain block computation, expression folding is off in this example.)

```
/* Gain Block: <S1>/theGain */
rtb_temp0 *= (22.0);
```

**Tunable Expression Limitations.** Currently, there are certain limitations on the use of tunable variables in expressions. When an unsupported expression is encountered during code generation a warning is issued and the equivalent numeric value is generated in the code. The limitations on tunable expressions are

- Complex expressions are not supported, except where the expression is simply the name of a complex variable.
- The use of certain operators or functions in expressions containing tunable operands is restricted. Restrictions are applied to four categories of operators or functions, classified in the following table:

Category	Operators or Functions
1	+ - .* ./ < > <= >= == ~= &
2	* /
3	abs, acos, asin, atan, atan2, boolean, ceil, cos, cosh, exp, floor, log, log10, sign, sin, sinh, sqrt, tan, tanh,
4	single, int8, int16, int32, uint8, uint16, uint32
5	: .^ ^ [] {} . \ .\ ' .' ; ,

The rules applying to each category are as follows:

- Category 1 is unrestricted. These operators can be used in tunable expressions with any combination of scalar or vector operands.
- Category 2 operators can be used in tunable expressions where at least one operand is a scalar. That is, scalar/scalar and scalar/matrix operand combinations are supported, but not matrix/matrix.
- Category 3 lists all functions that support tunable arguments. Tunable arguments passed to these functions retain their tunability. Tunable arguments passed to any other functions lose their tunability.
- Category 4 lists the casting functions that do not support tunable arguments. Tunable arguments passed to these functions lose their tunability.

---

**Note** The Simulink Coder product casts values using MATLAB typecasting rules. The MATLAB typecasting rules are different from C code typecasting rules. For example, using the MATLAB typecasting rules, `int8(3.7)` returns the result 4, while in C code `int8(3.7)` returns the result 3. See “Data Type Conversion” for more information on MATLAB typecasting.

---

- Category 5 operators are not supported.
- Expressions that include variables that were declared or modified in mask initialization code are *not* tunable.
- The Fcn block does not support tunable expressions in code generation.
- Model workspace parameters can take on only the Auto storage class, and thus are not tunable. See “Parameterize Model References” for tuning techniques that work with referenced models.
- Non-double expressions are not supported.
- Blocks that access parameters only by address support the use of tunable parameters, if the parameter expression is a simple variable reference. When an operation such as a data type conversion or a math operation is applied, the Simulink Coder product creates a nontrivial expression that cannot be accessed by address, resulting in an error during the build process.

### **Linear Block Parameter Tunability**

The following blocks have a `Realization` parameter that affects the tunability of their parameters:

- Transfer Fcn
- State-Space
- Discrete State-Space

The `Realization` parameter must be set by using the MATLAB `set_param` function, as in the following example.

```
set_param(gcf, 'Realization', 'auto')
```



The following values are defined for the Realization parameter:

- **general**: The block's parameters are preserved in the generated code, permitting parameters to be tuned.
- **sparse**: The block's parameters are represented in the code by transformed values that increase the computational efficiency. Because of the transformation, the block's parameters are no longer tunable.
- **auto**: This setting is the default. A **general** realization is used if one or more of the block's parameters are tunable. Otherwise **sparse** is used.

---

**Note** To tune the parameter values of a block of one of the above types without restriction during an External mode simulation, you must set Realization to **general**.

---

**Code Reuse for Subsystems with Mask Parameters.** The Simulink Coder product can generate reusable (reentrant) code for a model containing identical atomic subsystems. Selecting the **Reusable** function option for **Function packaging** enables such code reuse, and causes a single function with arguments to be generated that is called when any of the identical atomic subsystem executes. See “Subsystems” for details and restrictions on the use of this option.

Mask parameters become arguments to reusable functions. However, for reuse to occur, each instance of a reusable subsystem must declare the same set of mask parameters. If, for example subsystem A has mask parameters **b** and **K**, and subsystem B has mask parameters **c** and **K**, then code reuse is not possible, and the Simulink Coder product will generate separate functions for A and B.

### **Tunable Workspace Parameter Data Type Considerations**

If you are using tunable workspace parameters, you need to be aware of potential issues regarding data types. A workspace parameter is tunable when the following conditions exist:

- You select the **Inline parameters** option on the **Optimization > Signals and Parameters** pane of the Configuration Parameters dialog box

- The parameter has a storage class other than Auto

When generating code for tunable workspace parameters, the Simulink Coder product checks and compares the data types used for a particular parameter in the workspace and in Block Parameter dialog boxes.

If...	The Simulink Coder Product...
The data types match	Uses that data type for the parameter in the generated code.
You do not explicitly specify a data type other than <code>double</code> in the workspace	<p>Uses the data type specified by the block in the generated code. If multiple blocks share a parameter, they must all specify the same data type. If the data type varies between blocks, the product generates an error similar to the following:</p> <pre>Variable 'K' is used in incompatible ways in the dialog fields of the following: cs_params/Gain, cs_params/Gain1. The variable'value is being used both directly and after a transformation. Only one of these usages is permitted for any given variable.</pre>
You explicitly specify a data type other than <code>double</code> in the workspace	Uses the data type from the workspace for the parameter. The block typecasts the parameter to the block specific data type before using it.

**Guidelines for Specifying Data Types.** The following table provides guidelines on specifying data types for tunable workspace parameters.

If You Want to...	Then Specify Data Types in...
Minimize memory usage ( <code>int8</code> instead of <code>single</code> )	The workspace explicitly
Avoid typecasting	Blocks only

If You Want to...	Then Specify Data Types in...
Interface to legacy or custom code	The workspace explicitly
Use the same parameter for multiple blocks that specify different data types	The workspace explicitly

The Simulink Coder product enforces limitations on the use of data types other than `double` in the workspace, as explained in “Limitations on Specifying Workspace Data Types Explicitly” on page 15-135.

**Limitations on Specifying Workspace Data Types Explicitly.** When you explicitly specify a data type other than `double` in the workspace, blocks typecast the parameter to another data type. This is an issue for blocks that use pointer access for their parameters. Blocks cannot use pointer access if they need to typecast the parameter before using it (because of a data type mismatch). Another case in which this occurs is for workspace variables with bias or fractional slope. Two possible solutions to these problems are

- Remove the explicit data type specification in the workspace for parameters used in such blocks.
- Modify the block so that it uses the parameter with the same data type as specified in the workspace. For example, the Lookup Table block uses the data types of its input signal to determine the data type that it uses to access the X-breakpoint parameter. You can prevent the block from typecasting the run-time parameter by converting the input signal to the data type used for X-breakpoints in the workspace. (Similarly, the output signal is used to determine the data types used to access the lookup table Y data.)

### Tune Parameters from the Command Line

When parameters are MATLAB workspace variables, the Model Parameter Configuration dialog box is the recommended way to see or set the properties of tunable parameters. In addition to that dialog box, you can also use MATLAB `get_param` and `set_param` commands.

---

**Note** You can also use `Simulink.Parameter` objects for tunable parameters. See “Configure Parameter Objects for Code Generation” on page 7-39 for details.

---

The following commands return the tunable parameters and corresponding properties:

- `get_param(gcs, 'TunableVars')`
- `get_param(gcs, 'TunableVarsStorageClass')`
- `get_param(gcs, 'TunableVarsTypeQualifier')`

The following commands declare tunable parameters or set corresponding properties:

- `set_param(gcs, 'TunableVars', str)`

The argument `str` (string) is a comma-separated list of variable names.

- `set_param(gcs, 'TunableVarsStorageClass', str)`

The argument `str` (string) is a comma-separated list of storage class settings.

The valid storage class settings are

- `Auto`
  - `ExportedGlobal`
  - `ImportedExtern`
  - `ImportedExternPointer`
- `set_param(gcs, 'TunableVarsTypeQualifier', str)`

The argument `str` (string) is a comma-separated list of storage type qualifiers.

The following example declares the variable `k1` to be tunable, with storage class `ExportedGlobal` and type qualifier `const`. The number of variables and number of specified storage class settings must match. If you specify multiple variables and storage class settings, separate them with a comma.

```
set_param(gcs, 'TunableVars', 'k1')
set_param(gcs, 'TunableVarsStorageClass', 'ExportedGlobal')
set_param(gcs, 'TunableVarsTypeQualifier', 'const')
```

Other configuration parameters you can get and set are listed in “Parameter Reference”.

## Interfaces for Tuning Parameters

The Simulink Coder product includes

- Support for developing a Target Language Compiler API for tuning parameters independent of External mode. See “Parameter Functions” in the Target Language Compiler documentation for information.
- A C application program interface (API) for tuning parameters independent of External mode. See “Data Interchange Using the C API” on page 15-137 for information.
- An interface for exporting ASAP2 files, which you customize to use parameter objects. For details, see “ASAP2 Data Measurement and Calibration” on page 15-174.

## Data Interchange Using the C API

The C API allows you to write host-based or target-based code that interacts with signals, states, root-level inputs/outputs, and parameters in your target-based application code.

- “About Data Exchange and C API” on page 15-137
- “Generate C API Files” on page 15-138
- “Description of C API Files” on page 15-141
- “Use the C API in an Application” on page 15-160
- “C API Limitations” on page 15-173

## About Data Exchange and C API

Some Simulink Coder applications must interact with signals, states, root-level inputs/outputs, or parameters in the generated code for a model. For example, calibration applications monitor and modify parameters. Signal

monitoring or data logging applications interface with signal, state, and root-level input/output data. Using the Simulink Coder C API, you can build target applications that log signals, states, and root-level inputs/outputs, monitor signals, states, and root-level inputs/outputs, and tune parameters, while the generated code executes.

The C API minimizes its memory footprint by sharing information common to signals, states, root-level inputs/outputs, and parameters in smaller structures. Signal, state, root-level input/output, and parameter structures include an index into the structure map, allowing multiple signals, states, root-level inputs/outputs, or parameters to share data.

When you configure a model to use the C API, the Simulink Coder code generator generates two additional files, *model\_capi.c* (or *.cpp*) and *model\_capi.h*, where *model* is the name of the model. The code generator places the two C API files in the build folder, based on settings in the Configuration Parameters dialog box. The C API source code file contains information about global block output signals, states, root-level inputs/outputs, and global parameters defined in the generated code model source code. The C API header file is an interface header file between the model source code and the generated C API. You can use the information in these C API files to create your application. Among the files generated are those shown in the next figure.

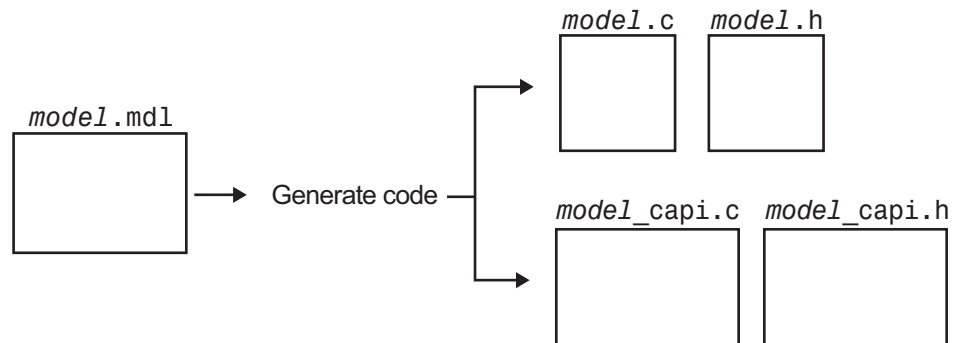

### Generated Files with C API Selected

### Generate C API Files

To generate C API files for your model:

- 1 Select the C API interface for your model. There are two ways to select the C API interface for your model, as described in the following sections.
  - “Select C API with Configuration Parameters Dialog” on page 15-139
  - “Select C API from the Command Line” on page 15-140
- 2 Generate code for your model.

After generating code, you can examine the files `model_capi.c` (or `.cpp`) and `model_capi.h` in the model build folder.

### Select C API with Configuration Parameters Dialog.

- 1 Open your model, and launch either the Configuration Parameters dialog box or Model Explorer.
- 2 Go to the **Code Generation > Interface** pane and, in the **Data exchange** section, select C API as the value for the **Interface** parameter. The **Generate C API for: signals**, **Generate C API for: parameters**, **Generate C API for: states**, and **Generate C API for: root-level I/O** check boxes are displayed.

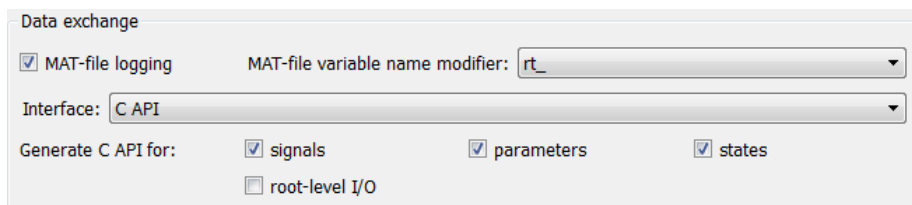

- 3 Select options:
  - If you want to generate C API code for global block output signals, select the **Generate C API for: signals** check box.
  - If you want to generate C API code for global block parameters, select the **Generate C API for: parameters** check box.
  - If you want to generate C API code for discrete and continuous states, select the **Generate C API for: states** check box.
  - If you want to generate C API code for root-level inputs and outputs, select the **Generate C API for: root-level I/O** check box.

If you select all four check boxes, support for accessing signals, parameters, states, and root-level I/O will appear in the C API generated code.

**Select C API from the Command Line.** From the MATLAB command line, you can use the `set_param` function to select or clear the C API check boxes on the **Interface** pane of the Configuration Parameters dialog box. At the MATLAB command line, enter one or more of the following commands, where `modelName` is the name of your model.

To select **Generate C API for: signals**, enter:

```
set_param('modelName', 'RTWCAPISignals', 'on')
```

To clear **Generate C API for: signals**, enter:

```
set_param('modelName', 'RTWCAPISignals', 'off')
```

To select **Generate C API for: parameters**, enter:

```
set_param('modelName', 'RTWCAPIParams', 'on')
```

To clear **Generate C API for: parameters**, enter:

```
set_param('modelName', 'RTWCAPIParams', 'off')
```

To select **Generate C API for: states**, enter:

```
set_param('modelName', 'RTWCAPISStates', 'on')
```

To clear **Generate C API for: states**, enter:

```
set_param('modelName', 'RTWCAPISStates', 'off')
```

To select **Generate C API for: root-level I/O**, enter:

```
set_param('modelName', 'RTWCAPIRootIO', 'on')
```

To clear **Generate C API for: root-level I/O**, enter:

```
set_param('modelName', 'RTWCAPIRootIO', 'off')
```



**Generate C API and ASAP2 Files.** The C API and ASAP2 interfaces are not mutually exclusive. Although the **Interface** option on the **Code Generation > Interface** pane of the Configuration Parameters dialog box allows you to select either the ASAP2 or C API interface, you can instruct the Simulink Coder code generator to generate files for both interfaces. For details, see “Generate ASAP2 and C API Files” on page 15-188.

## Description of C API Files

- “About C API Files” on page 15-141
- “Structure Arrays Generated in C API Files” on page 15-144
- “Generate Example C API Files” on page 15-146
- “C API Signals” on page 15-149
- “C API States” on page 15-153
- “C API Root-Level Inputs and Outputs” on page 15-154
- “C API Parameters” on page 15-156
- “Map C API Data Structures to rtModel” on page 15-158

**About C API Files.** The *model\_capi.c* (or *.cpp*) file provides external applications with a consistent interface to model data. Depending on your configuration settings, the data could be a signal, state, root-level input or output, or parameter. In this document, the term *data item* refers to either a signal, a state, a root-level input or output, or a parameter. The C API uses structures that provide an interface to the data item properties. The interface packages the properties of each data item in a data structure. If the model contains multiple data items, the interface generates an array of data structures. The members of a data structure map to data properties.

To interface with data items, an application requires the following properties for each data item:

- Name
- Block path
- Port number (for signals and root-level inputs/outputs only)

- Address
- Data type information: native data type, data size, complexity, and other attributes
- Dimensions information: number of rows, number of columns, and data orientation (scalar, vector, matrix, or  $n$ -dimensional)
- Fixed-point information: slope, bias, scale type, word length, exponent, and other attributes
- Sample-time information (for signals, states, and root-level inputs/outputs only): sample time, task identifier, frames

As illustrated in the next figure, the properties of data item A, for example, are located in data structure DS\_A. The properties of data item B are located in data structure DS\_B.

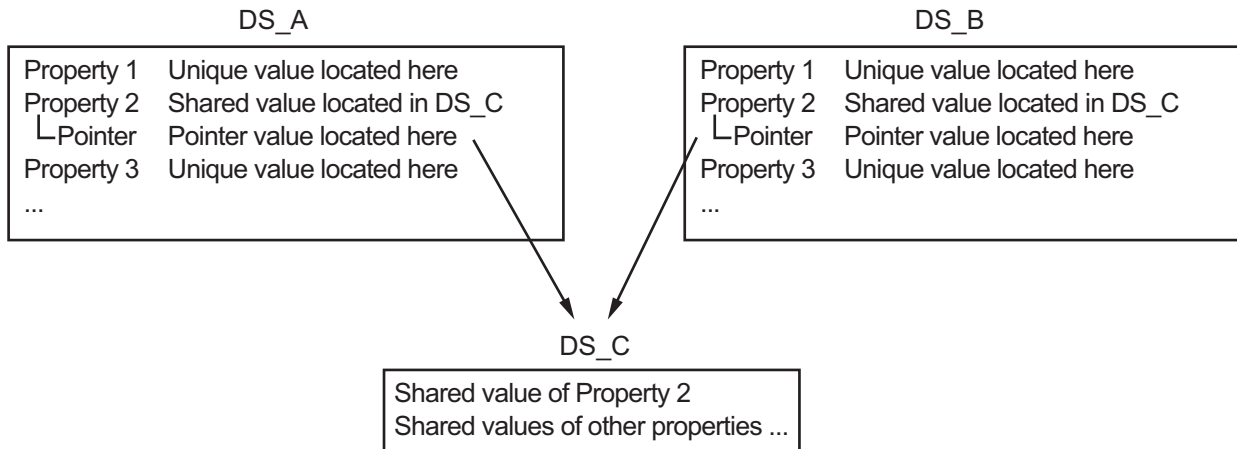

Some property *values* can be unique to each data item, and there are some property values that several data items can share in common. Name, for example, has a unique value for each data item. The interface places the unique property values directly in the structure for the data item. The name value of data item A is in DS\_A, and the name value of data item B is in DS\_B.

But data type could be a property whose value several data items have in common. The ability of some data items to share a property allows the C API to have a reuse feature. In this case, the interface places only an index value

in DS\_A and an index value in DS\_B. These indices point to a different data structure, DS\_C, that contains the actual data type value. The next figure shows this scheme with more detail.

### Array of Signal Structures

```

rtwCapi_Signals rtBlockSignals[]
{
  {
    ...
    blockPath      sys/blk1
    signalName     signal1
    portNumber     0
    dataTypeIndex  0
    ...
  },
  {
    ...
    blockPath      sys/blk2
    signalName     signal2
    portNumber     1
    dataTypeIndex  0
    ...
  },
  {
    ...
    blockPath      sys/blk3
    signalName     signal3
    portNumber     0
    dataTypeIndex  1
    ...
  }
};

```

These indices of 0 point to the first element in the rtDataTypeMap array.

The index of 1 points to the second element in the rtDataTypeMap array.

### Array of Data Type Structures

```

rtwCapi_DataTypeMap rtDataTypeMap[]
{
  {
    cName          "double"
    mwName         "real_T"
    numElements    0
    elemMapIndex   0
    dataSize       sizeof(real_T)
    slDataId       SS_DOUBLE
    isComplex      0
    isPointer      0
  };
  {
    cName          "int"
    mwName         "int32_T"
    numElements    0
    elemMapIndex   0
    dataSize       sizeof(int32_T)
    slDataId       SS_INT32
    ...
  }
};

```

The figure shows three signals. `signal1` and `signal2` share the same data type, `double`. Instead of specifying this data type value in each signal data structure, the interface provides only an index value, 0, in the structure. "double" is described by entry 0 in the `rtDataTypeMap` array, which is referenced by both signals. Additionally, property values can be shared between signals, states, root-level inputs/outputs, and parameters, so states, root-level inputs/outputs, and parameters also might reference the `double` entry in the `rtDataTypeMap` array. This reuse of information reduces the memory size of the generated interface.

**Structure Arrays Generated in C API Files.** As with data type, the interface maps other common properties (such as address, dimension, fixed-point scaling, and sample time) into separate structures and provides an index in the structure for the data item. For a complete list of structure definitions, refer to the file `matlabroot/rtw/c/src/rtw_capi.h` (where `matlabroot` represents the root of your MATLAB installation folder). This file also describes each member in a structure. The structure arrays generated in the `model_capi.c` (or `.cpp`) file are of structure types defined in the `rtw_capi.h` file. Here is a brief description of the structure arrays generated in `model_capi.c` (or `.cpp`):

- **rtBlockSignals** is an array of structures that contains information about global block output signals in the model. Each element in the array is of type `struct rtwCAPI_Signals`. The members of this structure provide the signal name, block path, block port number, address, and indices to the data type, dimension, fixed-point, and sample-time structure arrays.
- **rtBlockParameters** is an array of structures that contains information about the tunable block parameters in the model by block name and parameter name. Each element in the array is of type `struct rtwCAPI_BlockParameters`. The members of this structure provide the parameter name, block path, address, and indices to data type, dimension, and fixed-point structure arrays.
- **rtBlockStates** is an array of structures that contains information about discrete and continuous states in the model. Each element in the array is of type `struct rtwCAPI_States`. The members of this structure provide the state name, block path, type (continuous or discrete), and indices to the address, data type, dimension, fixed-point, and sample-time structure arrays.

- **rtRootInputs** is an array of structures that contains information about root-level inputs in the model. Each element in the array is of type `struct rtwC_API_Signals`. The members of this structure provide the root-level input name, block path, block port number, address, and indices to the data type, dimension, fixed-point, and sample-time structure arrays.
- **rtRootOutputs** is an array of structures that contains information about root-level outputs in the model. Each element in the array is of type `struct rtwC_API_Signals`. The members of this structure provide the root-level output name, block path, block port number, address, and indices to the data type, dimension, fixed-point, and sample-time structure arrays.
- **rtModelParameters** is an array of structures that contains information about all workplace variables that one or more blocks or Stateflow charts in the model reference as block parameters. Each element in the array is of data type `rtwC_API_ModelParameters`. The members of this structure provide the variable name, address, and indices to data type, dimension, and fixed-point structure arrays.
- **rtDataAddrMap** is an array of base addresses of signals, states, root-level inputs/outputs, and parameters that appear in the `rtBlockSignals`, `rtBlockParameters`, `rtBlockStates`, and `rtModelParameters` arrays. Each element of the `rtDataAddrMap` array is a pointer to void (`void*`).
- **rtDataTypeMap** is an array of structures that contains information about the various data types in the model. Each element of this array is of type `struct rtwC_API_DataTypeMap`. The members of this structure provide the data type name, size of the data type, and information on whether or not the data is complex.
- **rtDimensionMap** is an array of structures that contains information about the various data dimensions in the model. Each element of this array is of type `struct rtwC_API_DimensionMap`. The members of this structure provide information on the number of dimensions in the data, the orientation of the data (whether it is scalar, vector, or a matrix), and the actual dimensions of the data.
- **rtFixPtMap** is an array of structures that contains fixed-point information about the signals, states, root-level inputs/outputs, and parameters. Each element of this array is of type `struct rtwC_API_FixPtMap`. The members of this structure provide information about the data scaling, bias, exponent, and whether or not the fixed-point data is signed. If the model does not have fixed-point data (signal, state, root-level input/output, or parameter),

the Simulink Coder software assigns NULL or zero values to the elements of the `rtFixPtMap` array.

- **`rtSampleTimeMap`** is an array of structures that contains sampling information about the global signals, states, and root-level inputs/outputs in the model. (This array contains no information about parameters.) Each element of this array is of type `struct rtwC_API_SampleTimeMap`. The members of this structure provide information about the sample period, offset, and whether or not the data is frame-based or sample-based.

**Generate Example C API Files.** The next three sections, “C API Signals” on page 15-149, “C API States” on page 15-153, “C API Root-Level Inputs and Outputs” on page 15-154, and “C API Parameters” on page 15-156, discuss generated C API structures using the example model `rtwdemo_capi` as an example. To generate code from the example model, do the following:

- 1 Open the model by clicking the `rtwdemo_capi` link above or by typing `rtwdemo_capi` on the MATLAB command line. The model appears as shown in the next figure.

This model illustrates the target-based C API for interfacing signals, parameters and states in the generated code. The C API is useful for real-time interaction with the data, without having to stop execution or recompile the generated code. Typically, a client/server protocol is set up from a host to a target using serial, TCP/IP, or dual-port memory connection. The purpose of this example is not the client/server protocol. Rather, this model shows the necessary data interface required by the C client/server programs.

The C-API is enabled by setting the Code Generation option "Data Exchange" to C API. Any signal or parameter or state with an addressable storage class is placed in the C API data structure in <model>\_capi.c. Note that signals, states and parameters in the referenced model can be accessed using C-API. So ensure that C-API is enabled for the referenced model.

[Generate Code Using Simulink Coder \(double-click\)](#)
[Generate Code Using Embedded Coder \(double-click\)](#)
[View Interface Configuration \(double-click\)](#)
[View Workspace Variables \(double-click\)](#)

Copyright 1994-2012 The MathWorks, Inc.

- 2 If you want to generate C API structures for root-level inputs/outputs in `rtwdemo_capi`, open the Configuration Parameters dialog box, go to the **Code Generation** > **Interface** pane, and make sure that the option **Generate C API for: root-level I/O** is selected.

---

**Note** The setting of **Generate C API for: root-level I/O** must match between the top model and the referenced model.

---

**3** Generate code for the model by double-clicking **Generate Code Using Simulink Coder**.

---

**Note** The C API code examples in the next four sections are generated with C as the target language.

---

This model has three global block output signals that will appear in C API generated code:

- `top_sig1`, which is a test point at the output of the Gain1 block in the top model
- `sig2_eg`, which appears in the top model and is defined in the base workspace as a `Simulink.Signal` object having storage class `ExportedGlobal`
- `bot_sig1`, which appears in the submodel `rtwdemo_capi_bot` and is defined as a `Simulink.Signal` object having storage class `SimulinkGlobal`

The model also has two discrete states that will appear in the C API generated code:

- `top_state`, which is defined for the Delay1 block in the top model
- `bot_state`, which is defined for the Discrete Filter block in the submodel

The model has root-level inputs/outputs that will appear in the C API generated code if you select the option **Generate C API for: root-level I/O**:

- Four root-level inputs, `In1` through `In4`
- Six root-level outputs, `Out1` through `Out6`

Additionally, the model has five global block parameters that will appear in C API generated code:



- Kp (top model Gain1 block and submodel Gain2 block share)
- Ki (submodel Gain3 block)
- p1 (lookup table lu1d)
- p2 (lookup table lu2d)
- p3 (lookup table lu3d)

**C API Signals.** The `rtwCAPI_Signals` structure captures signal information including the signal name, address, block path, output port number, data type information, dimensions information, fixed-point information, and sample-time information.

Here is the section of code in `rtwdemo_capi_capi.c` that provides information on C API signals for the top model in `rtwdemo_capi`:

```

/* Block output signal information */
static const rtwCAPI_Signals rtBlockSignals[] = {
    /* addrMapIndex, sysNum, blockPath,
     * signalName, portNumber, dataTypeIndex, dimIndex, fxpIndex, sTimeIndex
     */
    { 0, 0, "rtwdemo_capi/Gain1",
      "top_sig1", 0, 0, 0, 0, 0 },

    { 1, 0, "rtwdemo_capi/lu2d",
      "sig2_eg", 0, 0, 1, 0, 0 },

    {
      0, 0, (NULL), (NULL), 0, 0, 0, 0, 0
    }
};

```

**Note** To better understand the code, read the comments in the file. For example, notice the comment that begins on the third line in the preceding code. This comment lists the members of the `rtwCapi_Signals` structure, in order. This tells you the order in which the assigned values for each member appear for a signal. In this example, the comment tells you that `signalName` is the fourth member of the structure. The following lines describe the first signal:

```
{ 0, 0, "rtwdemo_capi/Gain1",  
  "top_sig1", 0, 0, 0, 0, 0 },
```

From these lines you infer that the name of the first signal is `top_sig1`.

---

Each array element, except the last, describes one output port for a block signal. The final array element is a sentinel, with all elements set to null values. For example, examine the second signal, described by the following code:

```
{ 1, 0, "rtwdemo_capi/lu2d",  
  "sig2_eg", 0, 0, 1, 0, 0 },
```

This signal, named `sig2_eg`, is the output signal of the first port of the block `rtwdemo_capi/lu2d`. (This port is the first port because the zero-based index for `portNumber` displayed on the second line is assigned the value 0.)

The address of this signal is given by `addrMapIndex`, which, in this example, is displayed on the first line as 1. This provides an index into the `rtDataAddrMap` array, found later in `rtwdemo_capi_capi.c`:

```
/* Declare Data Addresses statically */  
static void* rtDataAddrMap[] = {  
    &rtwdemo_capi_B.top_sig1,           /* 0: Signal */  
    &sig2_eg[0],                       /* 1: Signal */  
    &rtwdemo_capi_DWork.top_state,     /* 2: Discrete State */  
    &rtP_Ki,                           /* 3: Model Parameter */  
    &rtP_Kp,                           /* 4: Model Parameter */  
    &rtP_p1[0],                        /* 5: Model Parameter */  
    &rtP_p2[0],                        /* 6: Model Parameter */  
    &rtP_p3[0],                        /* 7: Model Parameter */
```

```
};
```

The index of 1 points to the second element in the `rtDataAddrMap` array. From the `rtDataAddrMap` array, you can infer that the address of this signal is `&sig2_eg[0]`.

This level of indirection supports multiple code instances of the same model. For multiple instances, the signal information remains constant, except for the address. In this case, the model is a single instance. Therefore, the `rtDataAddrMap` is declared statically. If you choose to generate reusable code, an initialize function is generated that initializes the addresses dynamically per instance. (For details on generating reusable code, see “Set Up Support for Code Reuse” and “Entry Point Functions and Scheduling” in the Embedded Coder documentation.)

The `dataTypeIndex` provides an index into the `rtDataTypeMap` array, found later in `rtwdemo_capi_capi.c`, indicating the data type of the signal:

```
/* Data Type Map - use dataTypeMapIndex to access this structure */
static const rtwCAPI_DataTypeMap rtDataTypeMap[] = {
    /* cName, mwName, numElements, elemMapIndex, dataSize, sldataId, *
     * isComplex, isPointer */
    { "double", "real_T", 0, 0, sizeof(real_T), SS_DOUBLE, 0, 0 }
};
```

Because the index is 0 for `sig2_eg`, the index points to the first structure element in the array. You can infer that the data type of the signal is `double`. The value of `isComplex` is 0, indicating that the signal is not complex. Rather than providing the data type information directly in the `rtwCAPI_Signals` structure, a level of indirection is introduced. The indirection allows multiple signals that share the same data type to point to one map structure, saving memory for each signal.

The `dimIndex` (dimensions index) provides an index into the `rtDimensionMap` array, found later in `rtwdemo_capi_capi.c`, indicating the dimensions of the signal. Because this index is 1 for `sig2_eg`, the index points to the second element in the `rtDimensionMap` array:

```
/* Dimension Map - use dimensionMapIndex to access elements of ths structure*/
static const rtwCAPI_DimensionMap rtDimensionMap[] = {
    /* dataOrientation, dimArrayIndex, numDims, vardimsIndex */
```

```
    { rtwCAPI_SCALAR, 0, 2, 0 },  
  
    { rtwCAPI_VECTOR, 2, 2, 0 },  
    ...  
};
```

From this structure, you can infer that this is a nonscalar signal having a dimension of 2. The `dimArrayIndex` value, 2, provides an index into `rtDimensionArray`, found later in `rtwdemo_capi_capi.c`:

```
/* Dimension Array- use dimArrayIndex to access elements of this array */  
static const uint_T rtDimensionArray[] = {  
    1,                               /* 0 */  
    1,                               /* 1 */  
    2,                               /* 2 */  
    ...  
};
```

The `fxpIndex` (fixed-point index) provides an index into the `rtFixPtMap` array, found later in `rtwdemo_capi_capi.c`, indicating any fixed-point information about the signal. Your code can use the scaling information to compute the real-world value of the signal, using the equation  $V = SQ + B$ , where  $V$  is “real-world” (that is, base-10) value,  $S$  is user-specified slope,  $Q$  is “quantized fixed-point value” or “stored integer,” and  $B$  is user-specified bias. (For details, see “Scaling” in the Fixed-Point Toolbox™ documentation.)

Because this index is 0 for `sig2_eg`, the signal has no fixed-point information. A fixed-point map index of zero always means that the signal has no fixed-point information.

The `sTimeIndex` (sample-time index) provides the index to the `rtSampleTimeMap` array, found later in `rtwdemo_capi_capi.c`, indicating task information about the signal. If you log multirate signals or conditionally executed signals, the sampling information can be useful.

---

**Note** `model_capi.c` (or `.cpp`) includes `rtw_capi.h`. Any source file that references the `rtBlockSignals` array also must include `rtw_capi.h`.

---

**C API States.** The `rtwCAPI_States` structure captures state information including the state name, address, block path, type (continuous or discrete), data type information, dimensions information, fixed-point information, and sample-time information.

Here is the section of code in `rtwdemo_capi_capi.c` that provides information on C API states for the top model in `rtwdemo_capi`:

```
/* Block states information */
static const rtwCAPI_States rtBlockStates[] = {
    /* addrMapIndex, contStateStartIndex, blockPath,
     * stateName, pathAlias, dWorkIndex, dataTypeIndex, dimIndex,
     * fixPtIdx, sTimeIndex, isContinuous
     */
    { 2, -1, "rtwdemo_capi/Delay1",
      "top_state", "", 0, 0, 0, 0, 0, 0 },

    {
        0, -1, (NULL), (NULL), (NULL), 0, 0, 0, 0, 0, 0
    }
};
```

Each array element, except the last, describes a state in the model. The final array element is a sentinel, with all elements set to null values. In this example, the C API code for the top model displays one state:

```
{ 2, -1, "rtwdemo_capi/Delay1",
  "top_state", "", 0, 0, 0, 0, 0, 0 },
```

This state, named `top_state`, is defined for the block `rtwdemo_capi/Delay1`. The value of `isContinuous` is zero, indicating that the state is discrete rather than continuous. The other fields correspond to the like-named signal equivalents described in “C API Signals” on page 15-149, as follows:

- The address of the signal is given by `addrMapIndex`, which, in this example, is 2. This is an index into the `rtDataAddrMap` array, found later in `rtwdemo_capi_capi.c`. Because the index is zero based, 2 corresponds to the third element in `rtDataAddrMap`, which is `&rtwdemo_capi_DWork.top_state`.

- The `dataTypeIndex` provides an index into the `rtDataTypeMap` array, found later in `rtwdemo_capi_capi.c`, indicating the data type of the parameter. The value 0 corresponds to a double, noncomplex parameter.
- The `dimIndex` (dimensions index) provides an index into the `rtDimensionMap` array, found later in `rtwdemo_capi_capi.c`. The value 0 corresponds to the first entry, which is { `rtwCAPI_SCALAR`, 0, 2, 0 }.
- The `fixPtIndex` (fixed-point index) provides an index into the `rtFixPtMap` array, found later in `rtwdemo_capi_capi.c`, indicating any fixed-point information about the parameter. As with the corresponding signal attribute, a fixed-point map index of zero always means that the parameter has no fixed-point information.

**C API Root-Level Inputs and Outputs.** The `rtwCAPI_Signals` structure captures root-level input/output information including the input/output name, address, block path, port number, data type information, dimensions information, fixed-point information, and sample-time information. (This structure also is used for block output signals, as previously described in “C API Signals” on page 15-149.)

Here is the section of code in `rtwdemo_capi_capi.c` that provides information on C API root-level inputs/outputs for the top model in `rtwdemo_capi`:

```
/* Root Inputs information */
static const rtwCAPI_Signals rtRootInputs[] = {
    /* addrMapIndex, sysNum, blockPath,
     * signalName, portNumber, dataTypeIndex, dimIndex, fxpIndex, sTimeIndex
     */
    { 3, 0, "rtwdemo_capi/In1",
      "", 1, 0, 0, 0, 0 },

    { 4, 0, "rtwdemo_capi/In2",
      "", 2, 0, 0, 0, 0 },

    { 5, 0, "rtwdemo_capi/In3",
      "", 3, 0, 0, 0, 0 },

    { 6, 0, "rtwdemo_capi/In4",
      "", 4, 0, 0, 0, 0 },
```

```
    {
        0, 0, (NULL), (NULL), 0, 0, 0, 0, 0
    }
};

/* Root Outputs information */
static const rtwCAPI_Signals rtRootOutputs[] = {
    /* addrMapIndex, sysNum, blockPath,
     * signalName, portNumber, dataTypeIndex, dimIndex, fxpIndex, sTimeIndex
     */
    { 7, 0, "rtwdemo_capi/Out1",
      "", 1, 0, 0, 0, 0 },

    { 8, 0, "rtwdemo_capi/Out2",
      "", 2, 0, 0, 0, 0 },

    { 9, 0, "rtwdemo_capi/Out3",
      "", 3, 0, 0, 0, 0 },

    { 10, 0, "rtwdemo_capi/Out4",
      "", 4, 0, 0, 0, 0 },

    { 11, 0, "rtwdemo_capi/Out5",
      "sig2_eg", 5, 0, 1, 0, 0 },

    { 12, 0, "rtwdemo_capi/Out6",
      "", 6, 0, 1, 0, 0 },

    {
        0, 0, (NULL), (NULL), 0, 0, 0, 0, 0
    }
};
```

For information about interpreting the values in the `rtwCAPI_Signals` structure, see the previous section “C API Signals” on page 15-149.

**C API Parameters.** The `rtwCAPI_BlockParameters` and `rtwCAPI_ModelParameters` structures capture parameter information including the parameter name, block path (for block parameters), address, data type information, dimensions information, and fixed-point information. Each element in an `rtBlockParameters` or `rtModelParameters` array (except the last element) corresponds to a tunable parameter in the model.

The setting of the **Inline parameters** option on the **Optimization > Signals and Parameters** pane of the Configuration Parameters dialog box determines how information is generated into the `rtBlockParameters` and `rtModelParameters` arrays in `model_capi.c` (or `.cpp`), as follows:

- If you clear **Inline parameters**:
  - The `rtBlockParameters` array contains an entry for every modifiable parameter of every block in the model.
  - The `rtModelParameters` array contains only Stateflow data of machine scope. The Simulink Coder software assigns its elements only NULL or zero values in the absence of such data.
- If you select **Inline parameters**:
  - The `rtBlockParameters` array is empty. The Simulink Coder software assigns its elements only NULL or zero values.
  - The `rtModelParameters` array contains entries for all workspace variables that are referenced as tunable Simulink block parameters or Stateflow data of machine scope.

Here is the `rtBlockParameters` array that is generated by default in `rtwdemo_capi_capi.c`:

```
/* Individual block tuning is not valid when inline parameters is *
 * selected. An empty map is produced to provide a consistent *
 * interface independent of inlining parameters. *
 */
static const rtwCAPI_BlockParameters rtBlockParameters[] = {
    /* addrMapIndex, blockPath,
     * paramName, dataTypeIndex, dimIndex, fixPtIdx
     */
    {
        0, (NULL), (NULL), 0, 0, 0
    }
};
```



```

    }
};

```

In this example, only the final, sentinel array element is generated, with all members of the structure `rtwCAPI_BlockParameters` set to `NULL` and zero values. This is because the **Inline parameters** option is selected by default for the `rtwdemo_capi` example model. If you clear this check box, the block parameters are generated in the `rtwCAPI_BlockParameters` structure.

Here is the `rtModelParameters` array that is generated by default in `rtwdemo_capi_capi.c`:

```

/* Tunable variable parameters */
static const rtwCAPI_ModelParameters rtModelParameters[] = {
    /* addrMapIndex, varName, dataTypeIndex, dimIndex, fixPtIndex */
    { 3, "Ki", 0, 0, 0 },

    { 4, "Kp", 0, 0, 0 },

    { 5, "p1", 0, 2, 0 },

    { 6, "p2", 0, 3, 0 },

    { 7, "p3", 0, 4, 0 },

    { 0, (NULL), 0, 0, 0 }
};

```

In this example, the `rtModelParameters` array contains entries for each variable that is referenced as a tunable Simulink block parameter.

For example, the `varName` (variable name) of the fourth parameter is `p2`. The other fields correspond to the like-named signal equivalents described in “C API Signals” on page 15-149, as follows:

- The address of the fourth parameter is given by `addrMapIndex`, which, in this example, is 6. This is an index into the `rtDataAddrMap` array, found later in `rtwdemo_capi_capi.c`. Because the index is zero based, 6 corresponds to the seventh element in `rtDataAddrMap`, which is `&rtwP_p2[0]`.

- The `dataTypeIndex` provides an index into the `rtDataTypeMap` array, found later in `rtwdemo_capi_capi.c`, indicating the data type of the parameter. The value 0 corresponds to a double, noncomplex parameter.
- The `dimIndex` (dimensions index) provides an index into the `rtDimensionMap` array, found later in `rtwdemo_capi_capi.c`. The value 3 corresponds to the fourth entry, which is { `rtwCAPI_MATRIX_COL_MAJOR`, 6, 2, 0 }.
- The `fixPtIndex` (fixed-point index) provides an index into the `rtFixPtMap` array, found later in `rtwdemo_capi_capi.c`, indicating any fixed-point information about the parameter. As with the corresponding signal attribute, a fixed-point map index of zero always means that the parameter has no fixed-point information.

**Map C API Data Structures to `rtModel`.** The real-time model data structure encapsulates model data and associated information that describes the model fully. When you select the C API feature and generate code, the Simulink Coder code generator adds another member to the real-time model data structure generated in `model.h`:

```
/*
 * DataMapInfo:
 * The following substructure contains information regarding
 * structures generated in the model's C API.
 */
struct {
    rtwCAPI_ModelMappingInfo mmi;
} DataMapInfo;
```

This member defines `mmi` (for model mapping information) of type `struct rtwCAPI_ModelMappingInfo`. The structure is located in `matlabroot/rtw/c/src/rtw_modelmap.h` (where `matlabroot` represents the root of your MATLAB installation folder). The `mmi` substructure defines the interface between the model and the C API files. More specifically, members of `mmi` map the real-time model data structure to the structures in `model_capi.c` (or `.cpp`).

Initializing values of `mmi` members to the arrays accomplishes the mapping, as shown in Map Model to C API Arrays of Structures on page 15-160. Each member points to one of the arrays of structures in the generated C API

file. For example, the address of the `rtBlockSignals` array of structures is allocated to the first member of the `mmi` substructure in `model.c` (or `.cpp`), using the following code in the `rtw_modelmap.h` file:

```
/* signals */
struct {
    rtwCAPI_Signals const *signals;    /* Signals Array */
    uint_T                numSignals; /* Num Signals */
    rtwCAPI_Signals const *rootInputs; /* Root Inputs array */
    uint_T                numRootInputs; /* Num Root Inputs */
    rtwCAPI_Signals const *rootOutputs; /* Root Outputs array */
    uint_T                numRootOutputs; /* Num Root Outputs */
} Signals;
```

The model initialize function in `model.c` (or `.cpp`) performs the initializing by calling the C API initialize function. For example, the following code is generated in the model initialize function for example model `rtwdemo_capi`:

```
/* Initialize DataMapInfo substructure containing ModelMap for C API */
rtwdemo_capi_InitializeDataMapInfo(rtwdemo_capi_M);
```

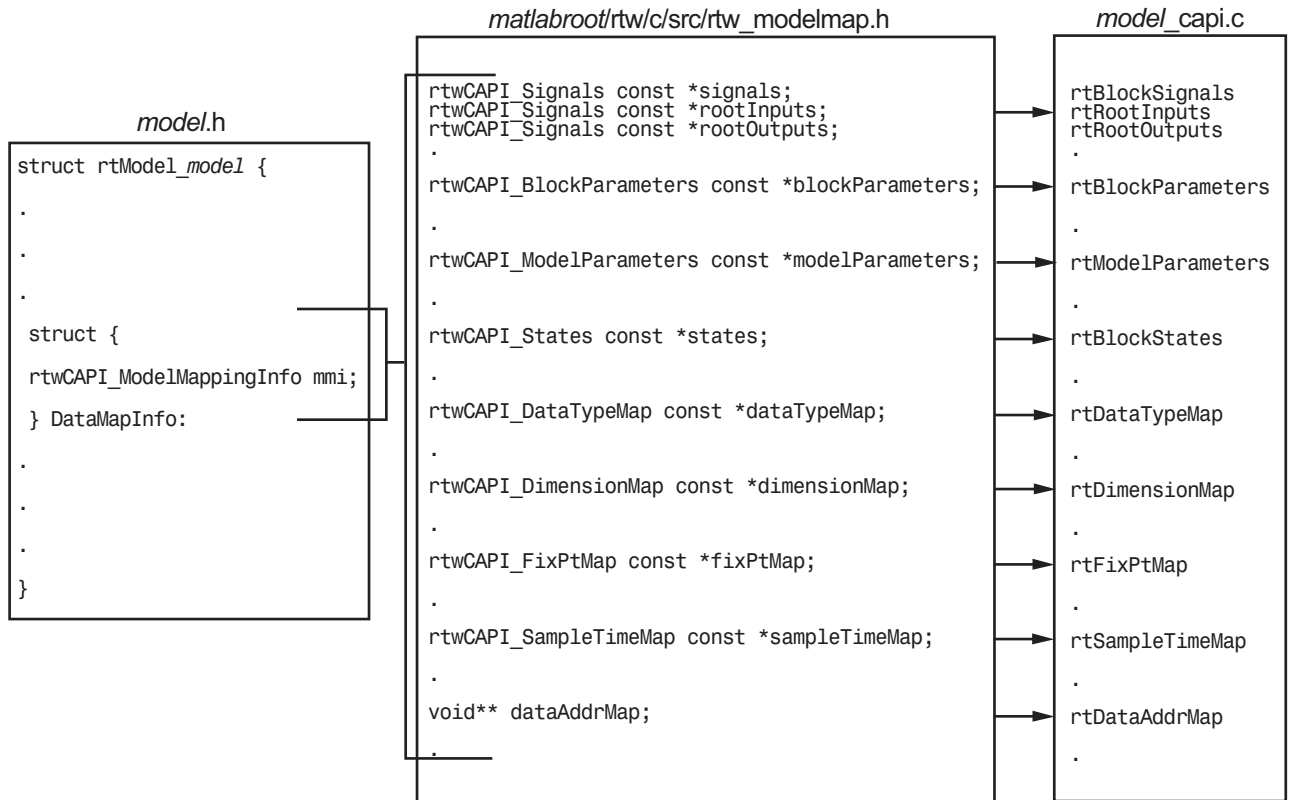

### Map Model to C API Arrays of Structures

---

**Note** This figure lists the arrays in the order that their structures appear in *rtw\_modelmap.h*, which differs slightly from their generated order in *model\_capi.c*.

---

### Use the C API in an Application

The C API provides you with the flexibility of writing your own application code to interact with model signals, states, root-level inputs/outputs, and parameters. Your target-based application code is compiled with the Simulink Coder generated code into an executable. The target-based application code accesses the C API structure arrays in *model\_capi.c* (or *.cpp*). You

might have host-based code that interacts with your target-based application code. Or, you might have other target-based code that interacts with your target-based application code. The files `rtw_modelmap.h` and `rtw_capi.h`, located in `matlabroot/rtw/c/src` (where `matlabroot` represents the root of your MATLAB installation folder), provide macros for accessing the structures in these arrays and their members.

This section provides examples to help you get started writing application code to interact with model signals, states, root-level inputs/outputs, and parameters.

- “Use C API to Access Model Signals and States” on page 15-161
- “Use C API to Access Model Parameters” on page 15-168

**Use C API to Access Model Signals and States.** Here is an example application that logs global signals and states in a model to a text file. This code is intended as a starting point for accessing signal and state addresses. You can extend the code to perform signal logging and monitoring, state logging and monitoring, or both.

This example uses the following macro and function interfaces:

- `rtmGetDataMapInfo` macro

Accesses the model mapping information (MMI) substructure of the real-time model structure. In the following macro call, `rtM` is the pointer to the real-time model structure in `model.c` (or `.cpp`):

```
rtwC_API_ModelMappingInfo* mmi = &(rtmGetDataMapInfo(rtM).mmi);
```

- `rtmGetTPtr` macro

Accesses the absolute time information for the base rate from the timing substructure of the real-time model structure. In the following macro call, `rtM` is the pointer to the real-time model structure in `model.c` (or `.cpp`):

```
rtmGetTPtr(rtM)
```

- Custom functions `capi_StartLogging`, `capi_UpdateLogging`, and `capi_TerminateLogging`, provided via the files `rtwdemo_capi_dataolog.h` and `rtwdemo_capi_dataolog.c`. These files are located in

*matlabroot*/toolbox/rtw/rtwdemos, where *matlabroot* represents the root of your MATLAB installation folder.

- `capi_StartLogging` initializes signal and state logging.
- `capi_UpdateLogging` logs a signal and state value at each time step.
- `capi_TerminateLogging` terminates signal and state logging and writes the logged values to a text file.

You can integrate these custom functions into generated model code using any or all of the following methods:

- **Code Generation > Custom Code** pane of the Configuration Parameters dialog box
- Custom Code library blocks
- TLC custom code functions

This tutorial uses the **Code Generation > Custom Code** pane and the System Outputs block from the Custom Code library to insert calls to the custom functions into *model.c* (or *.cpp*), as follows:

- `capi_StartLogging` is called in the `MdlStart` function (or if an `ert.tlc` target is selected for the model, in the `model_initialize` function).
- `capi_UpdateLogging` is called in the `model_output` function.
- `capi_TerminateLogging` is called in the `model_terminate` function.

The following excerpts of generated code from *model.c* (rearranged to reflect their order of execution) show how the function interfaces are used.

```
void MdlStart(void)
{
    /* user code (Start function Trailer) */

    /* C API Custom Logging Function: Start Signal and State logging via C-API.
     * capi_StartLogging: Function prototype in rtwdemo_capi_datalog.h
     */
    {
        rtwCAPI_ModelMappingInfo *MMI = &(rtmGetDataMapInfo(rtwdemo_capi_M).mmi);
        printf("** Started state/signal logging via C API **\n");
        capi_StartLogging(MMI, MAX_DATA_POINTS);
    }
}
```

```

...
}
...
/* Model output function */
static void rtwdemo_capi_output(int_T tid)
{
...
/* user code (Output function Trailer) */
/* C API Custom Logging Function: Update Signal and State logging buffers.
 * capi_UpdateLogging: Function prototype in rtwdemo_capi_datalog.h
 */
{
    rtwCAPI_ModelMappingInfo *MMI = &(rtmGetDataMapInfo(rtwdemo_capi_M).mmi);
    capi_UpdateLogging(MMI, rtmGetTPtr(rtwdemo_capi_M));
}
...
}
...
/* Model terminate function */
void rtwdemo_capi_terminate(void)
{
/* user code (Terminate function Trailer) */
/* C API Custom Logging Function: Dump Signal and State buffers into a text file.
 * capi_TerminateLogging: Function prototype in rtwdemo_capi_datalog.h
 */
{
    capi_TerminateLogging("rtwdemo_capi_ModelLog.txt");
    printf("*** Finished state/signal logging. Created rtwdemo_capi_ModelLog.txt **\n");
}
}
}

```

The following procedure illustrates how you can use the C API macro and function interfaces to log global signals and states in a model to a text file.

- 1** At the MATLAB command line, enter `rtwdemo_capi` to open the example model.
- 2** Open the Configuration Parameters dialog box and go to the **Code Generation** pane.

- 3** For the **System target file** parameter, select `grt.tlc`. (Alternatively, if you are licensed for Embedded Coder software, you can select `ert.tlc`. Make sure that you also select `ert.tlc` for the referenced model `rtwdemo_capi_bot`.)

---

**Note** Selecting a system target file other than `grt.tlc` or disabling some C API options (signals, parameters, or states) in the top model requires corresponding changes in the referenced model. Because the example models have read-only access, you must save the updated referenced model with a different name and modify the top model to reference the renamed model.

---

- 4** Go to the **Interface** pane.
- a** In the **Data exchange** subpane, for the **Interface** parameter, verify that C API is selected.
  - b** Additionally, verify that the options **Generate C API for: signals** and **Generate C API for: states** are selected. This example also leaves **Generate C API for: parameters** selected. If you clear any of the options, make sure that the settings match between the top model and the referenced model.

The screenshot shows the 'Data exchange' configuration pane. It includes a checked box for 'MAT-file logging' and a dropdown for 'MAT-file variable name modifier' set to 'rt\_'. The 'Interface' dropdown is set to 'C API'. Under the 'Generate C API for:' section, the checkboxes for 'signals', 'parameters', and 'states' are all checked, while 'root-level I/O' is unchecked.

- c** If you are using the `ert.tlc` target, verify that the options **MAT-file logging** and **Support: complex numbers** are selected.
  - d** If you modified any option settings in this step, click **Apply**.
- 5** Use the **Custom Code** pane to embed your custom application code in the generated code. Select the **Custom Code** pane, and then click **Include directories**. The **Include directories** input field is displayed.



- 6 In the **Include directories** field, type `matlabroot/toolbox/rtw/rtwdemos`, where `matlabroot` represents the root of your MATLAB installation folder.
- 7 In the **Include list of additional** subpane, click **Source files**, and type `rtwdemo_capi_datalog.c`, as shown below.

The screenshot shows a configuration dialog with two main sections. The top section is titled "Include custom C code in generated:" and contains a checkbox labeled "Use the same custom code settings as Simulation Target". Below this is a list of options: "Source file", "Header file", "Initialize function", and "Terminate function". The "Source file" option is selected, and a large empty text box labeled "Source file:" is provided for input. The bottom section is titled "Include list of additional:" and contains a list of options: "Include directories", "Source files", and "Libraries". The "Source files" option is selected, and a text box labeled "Source files:" contains the text `rtwdemo_capi_datalog.c`.

- 8** In the **Include custom C code in generated** subpane, click **Source file**, and type or copy and paste the following include statement:

```
#include "rtwdemo_capi_datalog.h"
```

- 9** In the **Initialize function** field, type or copy and paste the following application code:

```
/* C API Custom Logging Function: Start Signal and State logging via C-API.
 * capi_StartLogging: Function prototype in rtwdemo_capi_datalog.h
 */
{
    rtwCAPI_ModelMappingInfo *MMI = &(rtmGetDataMapInfo(rtwdemo_capi_M).mmi);
    printf("*** Started state/signal logging via C API **\n");
    capi_StartLogging(MMI, MAX_DATA_POINTS);
}
```

- 10** In the **Terminate function** field, type or copy and paste the following application code:

```
/* C API Custom Logging Function: Dump Signal and State buffers into a text file.
 * capi_TerminateLogging: Function prototype in rtwdemo_capi_datalog.h
 */
{
    capi_TerminateLogging("rtwdemo_capi_ModelLog.txt");
    printf("*** Finished state/signal logging. Created rtwdemo_capi_ModelLog.txt **\n");
}
```

- 11** Click **Apply**.

- 12** In the MATLAB Command Window, enter `custcode` to open the Simulink Coder Custom Code library. At the top level of the `rtwdemo_capi` model, add a System Outputs block.

- 13** Double-click the System Outputs block to open the System Outputs Function Custom Code dialog box. In the **System Outputs Function Exit Code** field, type or copy and paste the following application code:

```
/* C API Custom Logging Function: Update Signal and State logging buffers.
 * capi_UpdateLogging: Function prototype in rtwdemo_capi_datalog.h
 */
{
```

```

    rtwCAPI_ModelMappingInfo *MMI = &(rtmGetDataMapInfo(rtwdemo_capi_M).mmi);
    capi_UpdateLogging(MMI, rtmGetTPtr(rtwdemo_capi_M));
}

```

Click **OK**.

- 14** On the **Code Generation** pane, verify that the **Build** button is visible. If it is not visible, clear the option **Generate code only** and click **Apply**.

Click **Build** to build the model and generate an executable file. For example, on a Windows system, the build generates the executable file `rtwdemo_capi.exe`.

- 15** In the MATLAB Command Window, enter the command `!rtwdemo_capi` to run the executable file. During execution, signals and states are logged using the C API and then written to the text file `rtwdemo_capi_ModelLog.txt` in your working folder.

```

>> !rtwdemo_capi

** starting the model **
** Started state/signal logging via C API **
** Logging 2 signal(s) and 2 state(s). In this example, only scalar named
    signals/states are logged **
** Finished state/signal logging. Created rtwdemo_capi_ModelLog.txt **

```

- 16** Examine the text file in the MATLAB editor or any text editor. Here is an excerpt of the signal and state logging output.

```

***** Signal Log File *****

Number of Signals Logged: 2
Number of points (time steps) logged: 51

Time          bot_sig1 (Referenced Model)      top_sig1
0             70                               4
0.2           70                               4
0.4           70                               4
0.6           70                               4
0.8           70                               4
1             70                               4

```

```

1.2      70      4
1.4      70      4
1.6      70      4
1.8      70      4
2        70      4
...

```

```

***** State Log File *****

```

```

Number of States Logged: 2
Number of points (time steps) logged: 51

```

Time	bot_state (Referenced Model)	top_state
0	0	0
0.2	70	4
0.4	35	4
0.6	52.5	4
0.8	43.75	4
1	48.13	4
1.2	45.94	4
1.4	47.03	4
1.6	46.48	4
1.8	46.76	4
2	46.62	4
...		

**Use C API to Access Model Parameters.** Here is an example application that prints the parameter values of all tunable parameters in a model to the standard output. This code is intended as a starting point for accessing parameter addresses. You can extend the code to perform parameter tuning. The application:

- Uses the `rtmGetDataMapInfo` macro to access the mapping information in the `mmi` substructure of the real-time model structure

```

rtwCAPI_ModelMappingInfo* mmi = &(rtmGetDataMapInfo(rtM).mmi);

```

 where `rtM` is the pointer to the real-time model structure in `model.c` (or `.cpp`).
- Uses `rtwCAPI_GetNumModelParameters` to get the number of model parameters in mapped C API:

```
uint_T nModelParams = rtwCAPI_GetNumModelParameters(mmi);
```

- Uses `rtwCAPI_GetModelParameters` to access the array of all model parameter structures mapped in C API:

```
rtwCAPI_ModelParameters* capiModelParams = \
    rtwCAPI_GetModelParameters(mmi);
```

- Loops over the `capiModelParams` array to access individual parameter structures. A call to the function `capi_PrintModelParameter` displays the value of the parameter.

The example application code is provided below:

```
{
/* Get CAPI Mapping structure from Real-Time Model structure */
rtwCAPI_ModelMappingInfo* capiMap = \
&(rtmGetDataMapInfo(rtwdemo_capi_M).mmi);

/* Get number of Model Parameters from capiMap */
uint_T nModelParams = rtwCAPI_GetNumModelParameters(capiMap);
printf("Number of Model Parameters: %d\n", nModelParams);

/* If the model has Model Parameters, print them using the
application capi_PrintModelParameter */
if (nModelParams == 0) {
    printf("No Tunable Model Parameters in the model \n");
}
else {
    unsigned int idx;

    for (idx=0; idx < nModelParams; idx++) {
        /* call print utility function */
        capi_PrintModelParameter(capiMap, idx);
    }
}
}
```

The print utility function is located in `matlabroot/rtw/c/src/rtw_capi_examples.c` (where `matlabroot`

represents the root of your MATLAB installation folder). This file contains utility functions for accessing the C API structures.

To become familiar with the example code, try building a model that displays all the tunable block parameters and MATLAB variables. You can use `rtwdemo_capi`, the C API example model. The following steps apply to both `grt.tlc` and `ert.tlc` targets, unless otherwise indicated.

- 1** At the MATLAB command line, enter `rtwdemo_capi` to open the example model.
- 2** Open the Configuration Parameters dialog box and go to the **Optimization > Signals and Parameters** pane.
- 3** Verify that the **Inline parameters** option is selected.
- 4** If you are licensed for Embedded Coder software and you want to use the `ert.tlc` target instead of the default `grt.tlc`, go to the **Code Generation** pane and use the **System target file** field to select an `ert.tlc` target.
- 5** Use the **Custom Code** pane to embed your custom application code in the generated code. Select the **Custom Code** pane, and then click **Initialize function**. The **Initialize function** input field is displayed.
- 6** In the **Initialize function** input field, type or copy and paste the example application code shown above step 1. This embeds the application code in the `MdlStart` function. (If you are using `ert.tlc`, the code appears in the `model_initialize` function.)
- 7** Click **Include directories**, and type `matlabroot/rtw/c/src`, where `matlabroot` represents the root of your MATLAB installation folder.
- 8** In the **Include list of additional** subpane, click **Source files**, and type `rtw_capi_examples.c`.

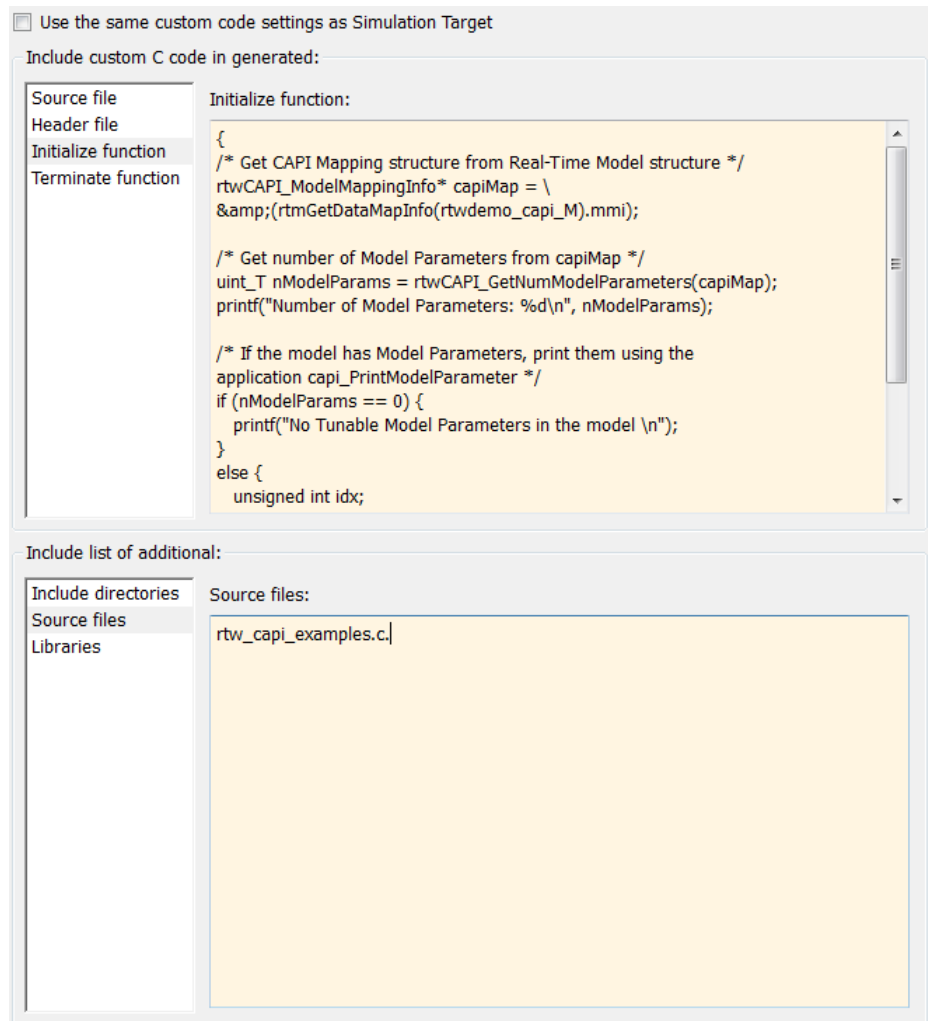

Click **Apply**.

- 9 If you are using the `ert.tlc` target, go to the **Code Generation > Interface** pane, select the following options, and then click **Apply**.

- In the **Interface** list, **C API**

- **MAT-file logging**
- **Support: complex numbers**

- 10** Go to the **Code Generation** pane and clear the **Generate code only** check box if it is not already cleared.
- 11** Click **Build**. The Simulink Coder code generator generates the executable file `rtwdemo_capi.exe` in your current working folder.
- 12** At the MATLAB command line, enter `!rtwdemo_capi` to run the executable file. Running the program displays parameter information in the Command Window.

```
>> !rtwdemo_capi

** starting the model **
Number of Model Parameters: 5
Ki =
    7
Kp =
    4
p1 =
    0.8147
    0.9058
    0.127
p2 =
    0.9649 0.9706 0.4854
    0.1576 0.9572 0.8003
p3 =
ans(:,:,1) =
    0.1419 0.9157 0.9595 0.03571
    0.4218 0.7922 0.6557 0.8491

ans(:,:,2) =
    0.934 0.7577 0.3922 0.1712
    0.6787 0.7431 0.6555 0.706

>>
```



## C API Limitations

The C API feature has the following limitations.

- The following code formats are not supported:
  - S-function
  - Accelerated simulation
- For ERT-based targets, the C API requires that support for floating-point code be enabled.
- Local block output signals are not supported.
- Local Stateflow parameters are not supported.
- The following custom storage class objects are not supported:
  - Objects without the package `csc_registration` file
  - `BitPackBoolean` objects, grouped custom storage classes, and objects defined by using macros
- Customized data placement is disabled when you are using the C API. The interface looks for global data declaration in `model.h` and `model_private.h`. Declarations placed in any other file by customized data placement result in code that does not compile.

---

**Note** Custom Storage Class objects take effect in code generation only if you use the ERT target and clear the **Ignore custom storage classes** check box in the Configuration Parameters dialog box.

---

## **ASAP2 Data Measurement and Calibration**

ASAP2 is a data definition standard proposed by the Association for Standardization of Automation and Measuring Systems (ASAM). ASAP2 is a non-object-oriented description of the data used for measurement, calibration, and diagnostic systems. For more information on ASAM and the ASAP2 standard, see the ASAM Web site at <http://www.asam.net>.

- “About ASAP2 Data Measurement and Calibration” on page 15-174
- “Targets Supporting ASAP2” on page 15-175
- “Define ASAP2 Information” on page 15-175
- “Generate an ASAP2 File” on page 15-182
- “Structure of the ASAP2 File” on page 15-187
- “Generate ASAP2 and C API Files” on page 15-188

### **About ASAP2 Data Measurement and Calibration**

The Simulink Coder product lets you export an ASAP2 file containing information about your model during the code generation process.

To make use of ASAP2 file generation, you should become familiar with the following topics:

- ASAM and the ASAP2 standard and terminology. See the ASAM Web site at <http://www.asam.net>.
- Simulink data objects. Data objects are used to supply information not contained in the model. For an overview, see “Data Objects”.
- Storage and representation of signals and parameters in generated code. See “Data Representation”.
- If you are licensed for Embedded Coder, see also the Embedded Coder topic “Data Representation”.

You can run an interactive example of ASAP2 file generation. To open the example at the MATLAB command prompt, enter the following command:

```
rtwdemo_asap2
```

---

**Note** Simulink Coder support for ASAP2 file generation is version-neutral. By default, the software generates ASAP2 version 1.31 format, but the generated model information is generally compatible with all ASAP2 versions. ASAP2 file generation also is neutral with respect to the specific needs of ASAP2 measurement and calibration tools. The software provides customization APIs that you can use to customize ASAP2 file generation to generate any ASAP2 version and to meet the specific needs of your ASAP2 tools.

---

## Targets Supporting ASAP2

ASAP2 file generation is available to all Simulink Coder target configurations. You can select these target configurations from the System Target File Browser. For example,

- The **Generic Real-Time Target (grt.tlc)** lets you generate an ASAP2 file as part of the code generation and build process.
- Any of the **Embedded Coder (ert.tlc)** target selections also lets you generate an ASAP2 file as part of the code generation and build process.
- The **ASAM-ASAP2 Data Definition Target (asap2.tlc)** lets you generate only an ASAP2 file, without building an executable.

Procedures for generating ASAP2 files by using these target configurations are given in “Generate an ASAP2 File” on page 15-182.

## Define ASAP2 Information

- “Define ASAP2 Information for Parameters and Signals” on page 15-176
- “Memory Address Attribute” on page 15-177
- “Automatic ECU Address Replacement for ASAP2 Files (Embedded Coder)” on page 15-178
- “Define ASAP2 Information for Lookup Tables” on page 15-180

**Define ASAP2 Information for Parameters and Signals.** The ASAP2 file generation process requires information about your model’s parameters and signals. Some of this information is contained in the model itself. You must supply the rest by using Simulink data objects and corresponding properties.

You can use built-in Simulink data objects to provide the information. For example, you can use `Simulink.Signal` objects to provide MEASUREMENT information and `Simulink.Parameter` objects to provide CHARACTERISTIC information. Also, you can use data objects from data classes that are derived from `Simulink.Signal` and `Simulink.Parameter` to provide the information. For details, see “Data Objects”.

The following table contains the minimum set of data attributes required for ASAP2 file generation. Some data attributes are defined in the model; others are supplied in the properties of objects. For attributes that are defined in `Simulink.Signal` or `Simulink.Parameter` objects, the table gives the associated property name.

<b>Data Attribute</b>	<b>Defined In</b>	<b>Property Name</b>
Name (symbol)	Data object	Inherited from the handle of the data object to which parameter or signal name resolves
Description	Data object	Description
Data type	Model	Not applicable
Scaling (if fixed-point data type)	Model	Data type (for signals) Inherited from value (for parameters)
Minimum allowable value	Data object	Min
Maximum allowable value	Data object	Max

Data Attribute	Defined In	Property Name
Units	Data object	DocUnits
Memory address (optional)	Data object	MemoryAddress_ASAP2 (optional; see “Memory Address Attribute” on page 15-177.)

**Memory Address Attribute.** If the memory address attribute is unknown before code generation, the code generator inserts an ECU Address placeholder string in the generated ASAP2 file. You can substitute an actual address for the placeholder by postprocessing the generated file. See the file `matlabroot/toolbox/rtw/targets/asap2/asap2/asap2post.m` for an example. `asap2post.m` parses through the linker map file that you provide and replaces the placeholder strings in the ASAP2 file with the actual memory addresses. Since linker map files vary from compiler to compiler, you might need to modify the regular expression code in `asap2post.m` to match the format of the linker map you use.

---

**Note** If Embedded Coder is licensed and installed on your system, and if you are generating ELF (Executable and Linkable Format) files for your embedded target, you can use the `rtw.asap2SetAddress` function to automate ECU address replacement. For more information, see “Automatic ECU Address Replacement for ASAP2 Files (Embedded Coder)” on page 15-178.

---

If the memory address attribute is known before code generation, it can be defined in the data object. By default, the `MemoryAddress_ASAP2` property does not exist in the `Simulink.Signal` or `Simulink.Parameter` data object classes. If you want to add the attribute, add a property called `MemoryAddress_ASAP2` to a custom class that is a subclass of the `Simulink` or `ASAP2` class. For information on subclassing Simulink data classes, see “Define Level-1 Data Classes” in the Simulink documentation.

---

**Note** In previous releases, for ASAP2 file generation, you had to define objects explicitly as `ASAP2.Signal` and `ASAP2.Parameter`. This is no longer a limitation. As explained above, you can use built-in Simulink objects for generating an ASAP2 file. If you have been using an earlier release, you can continue to use the ASAP2 objects. If one of these ASAP2 objects was created in the previous release, and you use it in this release, the MATLAB Command Window displays a warning the first time the objects are loaded.

---

The following table indicates the Simulink object properties that have replaced the ASAP2 object properties of the previous release:

### Differences Between ASAP2 and Simulink Parameter and Signal Object Properties

ASAP2 Object Properties (Previous)	Simulink Object Properties (Current)
LONGIG_ASAP2	Description
PhysicalMin_ASAP2	Min
PhysicalMax_ASAP2	Max
Units_ASAP2	DocUnits

**Automatic ECU Address Replacement for ASAP2 Files (Embedded Coder).** If Embedded Coder is licensed and installed on your system, and if you are generating ELF (Executable and Linkable Format) files for your embedded target, you can use the `rtw.asap2SetAddress` function to automate the replacement of ECU Address placeholder memory address values with actual addresses in the generated ASAP2 file.

If the memory address attribute is unknown before code generation, the code generator inserts an ECU Address placeholder string in the generated ASAP2 file, as shown in the example below.

```
/begin CHARACTERISTIC
/* Name          */ Ki
/* Long Identifier */ ""
/* Type          */ VALUE
```

```
/* ECU Address      */ 0x0  
/*ECU_Address@Ki@ */
```

To substitute actual addresses for the ECU Address placeholders, postprocess the generated ASAP2 file using the `rtw.asap2SetAddress` function. The general syntax is as follows:

```
rtw.asap2SetAddress(ASAP2File, InfoFile)
```

where the arguments are strings specifying the name of the generated ASAP2 file and the name of the generated executable ELF file or DWARF debug information file for the model. When called, `rtw.asap2SetAddress` extracts the actual ECU address from the specified ELF or DWARF file and replaces the placeholder in the ASAP2 file with the actual address, for example:

```
/begin CHARACTERISTIC  
/* Name           */ Ki  
/* Long Identifier */ "  
/* Type           */ VALUE  
/* ECU Address     */ 0x40009E60
```

**Define ASAP2 Information for Lookup Tables.** Simulink Coder software generates ASAP2 descriptions for lookup table data and its breakpoints. The software represents 1-D table data as CURVE information, 2-D table data as MAP information, and breakpoints as AXIS\_DESCR and AXIS\_PTS information. You can model lookup tables using any of the following Simulink Lookup Table blocks:

- Direct Lookup Table (n-D) — 1 and 2 dimensions
- Interpolation Using Prelookup — 1 and 2 dimensions
- 1-D Lookup Table
- 2-D Lookup Table
- n-D Lookup Table — 1 and 2 dimensions

The software supports the following types of lookup table breakpoints (axis points):

Breakpoint Type	Generates
Tunable and shared among multiple table axes (common axis)	COM_AXIS
Fixed and nontunable (fixed axis)	One of these variants of FIX_AXIS: <ul style="list-style-type: none"> <li>• FIX_AXIS_PAR if breakpoints are integers with equidistant spacing</li> <li>• FIX_AXIS_PAR_DIST if breakpoints are integers with equidistant spacing and the equidistant spacing is a power of two</li> <li>• FIX_AXIS_PAR_LIST if breakpoints are integers with non-equidistant spacing</li> </ul>
Tunable but not shared among multiple tables (standard axis)	STD_AXIS



When you configure the blocks for ASAP2 code generation:

- For table data, use a `Simulink.Parameter` data object with a non-Auto storage class.
- For tunable breakpoint data that is shared among multiple table axes (`COM_AXIS`), use a `Simulink.Parameter` data object with a non-Auto storage class.
- For fixed, nontunable breakpoint data (`FIX_AXIS`), use workspace variables or arrays specified in the block parameters dialog box. The breakpoints should be stored as integers in the code, so the data type should be a built-in integer type (`int8`, `int16`, `int32`, `uint8`, `uint16`, or `uint32`), a fixed-point data type, or an equivalent alias type.
- For tunable breakpoint data that is not shared among multiple tables (`STD_AXIS`):
  - 1** Create a `Simulink.Bus` object to define the struct packaging (names and order of the fields). The fields of the parameter structure must correspond to the lookup table data and each axis of the lookup table block. For example, in an n-D Lookup Table block with 2 dimensions, the structure must contain only three fields. This bus object describes the record layout for the lookup characteristic.
  - 2** Create a `Simulink.Parameter` object to represent a tunable parameter.
  - 3** Create table and axis values.
  - 4** Optionally, specify the **Units**, **Minimum**, and **Maximum** properties for the parameter object. The properties will be applied to table data only.

Here is an example of an n-D Lookup Table record generated into an ASAP2 file in Standard Axis format:

```
/begin CHARACTERISTIC
/* Name */  STDAxisParam
...
/* Record Layout */  Lookup1D_X_WORD_Y_FLOAT32_IEEE
...
begin AXIS_DESCR
/* Description of X-Axis Points */
/* Axis Type */  STD_AXIS
...

```

```
    /end AXIS_DESCR
/end CHARACTERISTIC

/begin RECORD_LAYOUT Lookup1D_X_WORD_Y_FLOAT32_IEEE
    AXIS_PTS_X 1 WORD INDEX_INCR DIRECT
    FNC_VALUES 2 FLOAT32_IEEE COLUMN_DIR DIRECT
/end RECORD_LAYOUT
```

---

**Note** The example model `rtwdemo_asap2` illustrates ASAP2 file generation for Lookup Table blocks, including both tunable (COM\_AXIS) and fixed (FIX\_AXIS) lookup table breakpoints.

---

## Generate an ASAP2 File

- “About Generating ASAP2 Files” on page 15-182
- “Use GRT or ERT Target” on page 15-182
- “Use the ASAM-ASAP2 Data Definition Target” on page 15-184
- “Generate ASAP2 Files for Referenced Models” on page 15-186
- “Merge ASAP2 Files for Top and Referenced Models” on page 15-186

**About Generating ASAP2 Files.** You can generate an ASAP2 file from your model in one of the following ways:

- Use the Generic Real-Time Target or an Embedded Coder target to generate an ASAP2 file as part of the code generation and build process.
- Use the ASAM-ASAP2 Data Definition Target to generate only an ASAP2 file, without building an executable.

This section discusses how to generate an ASAP2 file by using the targets that have built-in ASAP2 support. For an example, see the ASAP2 example model `rtwdemo_asap2`.

**Use GRT or ERT Target.** The procedure for generating a model’s data definition in ASAP2 format using the Generic Real-Time Target or an Embedded Coder target is as follows:

- 1 Create the desired model. Use parameter names and signal labels to refer to corresponding CHARACTERISTIC records and MEASUREMENT records , respectively.
- 2 Define the desired parameters and signals in the model to be `Simulink.Parameter` and `Simulink.Signal` objects in the MATLAB workspace. A convenient way of creating multiple signal and parameter data objects is to use the Data Object Wizard. Alternatively, you can create data objects one at a time from the MATLAB command line. For details on how to use the Data Object Wizard, see “Data Object Wizard” in the Simulink documentation.
- 3 For each data object, configure the **Storage class** property to a setting other than `Auto` or `SimulinkGlobal`. This declares the data object as global in the generated code. For example, a storage class setting of `ExportedGlobal` configures the data object as unstructured global in the generated code.

---

**Note** If you set the storage class to `Auto` or `SimulinkGlobal`, or if you set the storage class to `Custom` and custom storage class settings cause the Simulink Coder code generator to generate a macro or non-addressable variable, the data object is not represented in the ASAP2 file.

---

- 4 Configure the remaining properties as desired for each data object.
- 5 On the **Optimization > Signals and Parameters** pane of the Configuration Parameters dialog box, select the **Inline parameters** check box.

You should *not* configure the parameters associated with your data objects as Simulink global (tunable) parameters in the Model Parameter Configuration dialog box. If a parameter that resolves to a Simulink data object is configured using the Model Parameter Configuration dialog box, the dialog box configuration is ignored. You can, however, use the Model Parameter Configuration dialog box to configure other parameters in your model.

- 6** On the **Code Generation** pane, click **Browse** to open the System Target File Browser. In the browser, select **Generic Real-Time Target** or any embedded real-time target and click **OK**.
- 7** In the **Interface** field on the **Interface** pane, select **ASAP2**.

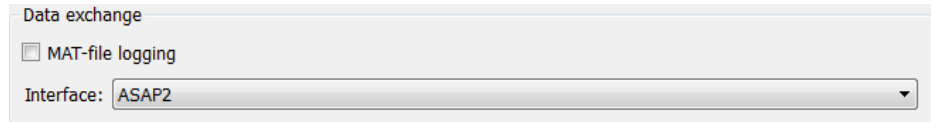

- 8** Select the **Generate code only** check box on the **Code Generation** pane.
- 9** Click **Apply**.
- 10** Click **Generate code**.

The Simulink Coder code generator writes the ASAP2 file to the build folder. By default, the file is named *model.a21*, where *model* is the name of the model. The ASAP2 filename is controlled by the ASAP2 setup file. For details see “Customize an ASAP2 File” on page 23-2.

**Use the ASAM-ASAP2 Data Definition Target.** The procedure for generating a model’s data definition in ASAP2 format using the ASAM-ASAP2 Data Definition Target is as follows:

- 1** Create the desired model. Use parameter names and signal labels to refer to corresponding CHARACTERISTIC records and MEASUREMENT records , respectively.
- 2** Define the desired parameters and signals in the model to be Simulink.Parameter and Simulink.Signal objects in the MATLAB workspace. A convenient way of creating multiple signal and parameter data objects is to use the Data Object Wizard. Alternatively, you can create data objects one at a time from the MATLAB command line. For details on how to use the Data Object Wizard, see “Data Object Wizard” in the Simulink documentation.
- 3** For each data object, configure the **Storage class** property to a setting other than Auto or SimulinkGlobal. This causes the data object to be declared as global in the generated code. For example, a storage class

setting of `ExportedGlobal` configures the data object as unstructured global in the generated code.

---

**Note** If you set the storage class to `Auto` or `SimulinkGlobal`, or if you set the storage class to `Custom` and custom storage class settings cause the Simulink Coder code generator to generate a macro or non-addressable variable, the data object is not represented in the ASAP2 file.

---

- 4 Configure the remaining properties as desired for each data object.
- 5 On the **Optimization > Signals and Parameters** pane of the Configuration Parameters dialog box, select the **Inline parameters** check box.

You should *not* configure the parameters associated with your data objects as Simulink global (tunable) parameters in the Model Parameter Configuration dialog box. If a parameter that resolves to a Simulink data object is configured using the Model Parameter Configuration dialog box, the dialog box configuration is ignored. You can, however, use the Model Parameter Configuration dialog box to configure other parameters in your model.

- 6 On the **Code Generation** pane, click **Browse** to open the System Target File Browser. In the browser, select **ASAM-ASAP2 Data Definition Target** and click **OK**.
- 7 Select the **Generate code only** check box on the **Code Generation** pane.
- 8 Click **Apply**.
- 9 Click **Generate code**.

The Simulink Coder code generator writes the ASAP2 file to the build folder. By default, the file is named `model.a21`, where `model` is the name of the model. The ASAP2 filename is controlled by the ASAP2 setup file. For details see “Customize an ASAP2 File” on page 23-2.

**Generate ASAP2 Files for Referenced Models.** The build process can generate an ASAP2 file for each referenced model in a model reference hierarchy. In the generated ASAP2 file, MEASUREMENT records represent signals and states inside the referenced model.

To generate ASAP2 files for referenced models, select ASAP2 file generation for the top model and for each referenced model in the reference hierarchy. For example, if you are using the Generic Real-Time Target or an Embedded Coder target, follow the procedure described in “Use GRT or ERT Target” on page 15-182 for the top model and each referenced model.

**Merge ASAP2 Files for Top and Referenced Models.** Use function `rtw.asap2MergeMdlRefs` to merge the ASAP2 files generated for top and referenced models. The function has the following syntax:

```
[status,info]=rtw.asap2MergeMdlRefs(topModelName,asap2FileName)
```

- `topModelName` is the name of the model containing one or more referenced models.
- `asap2FileName` is the name you specify for the merged ASAP2 file.
- *Optional*:: `status` returns false (logical 0) if the merge completes and true (logical 1) otherwise.
- *Optional*:: `info` returns additional information about merge failure if `status` is true. Otherwise, it returns an empty string.

Consider the following example.

```
[status,info]=rtw.asap2MergeMdlRefs('myTopMdl','merged.a21')
```

This command merges the ASAP2 files generated for the top model `myTopMdl` and its referenced models in the file `merged.a21`.

The example model `rtwdemo_asap2` includes an example of merging ASAP2 files.

## Structure of the ASAP2 File

The following table outlines the basic structure of the ASAP2 file and describes the Target Language Compiler (TLC) functions and files used to create each part of the file:

- Static parts of the ASAP2 file are shown in **bold**.
- Function calls are indicated by %<FunctionName()>.

File Section	Contents of asap2main.tlc	TLC File Containing Function Definition
File header	%<ASAP2UserFcnWriteFileHead()>	asap2userlib.tlc
<b>/begin PROJECT</b> ""	<b>/begin PROJECT</b> "%<ASAP2ProjectName>"	asap2setup.tlc
<b>/begin HEADER</b> "" HEADER contents	<b>/begin HEADER</b> "%<ASAP2HeaderName>" %<ASAP2UserFcnWriteHeader()>	asap2setup.tlc asap2userlib.tlc
<b>/end HEADER</b>	<b>/end HEADER</b>	
<b>/begin MODULE</b> "" MODULE contents:	<b>/begin MODULE</b> "%<ASAP2ModuleName>"}  - A2ML - MOD_PAR - MOD_COMMON ...	asap2setup.tlc asap2userlib.tlc
Model-dependent MODULE contents:	%<SLibASAP2WriteDynamicContents()> Calls user-defined functions:	asap2lib.tlc
- RECORD_LAYOUT - CHARACTERISTIC - ParameterGroups - ModelParameters	...WriteRecordLayout_TemplateName() ...WriteCharacteristic_TemplateName() ...WriteCharacteristic_Scalar()	user/templates/...
- MEASUREMENT - ExternalInputs - BlockOutputs	...WriteMeasurement()	asap2userlib.tlc
- COMPU_METHOD	...WriteCompuMethod()	asap2userlib.tlc

File Section	Contents of asap2main.tlc	TLC File Containing Function Definition
/end MODULE	/end MODULE	
File footer/tail	%<ASAP2UserFcnWriteFileTail()>	asap2userlib.tlc

### Generate ASAP2 and C API Files

The ASAP2 and C API interfaces are not mutually exclusive. Although the **Interface** option on the **Code Generation > Interface** pane of the Configuration Parameters dialog box allows you to select either the ASAP2 or C API interface, you can instruct the Simulink Coder product to generate files for both interfaces by doing the following:

- 1 On the **Code Generation > Interface** pane of the Configuration Parameters dialog box, select **C API** for the **Interface** option.

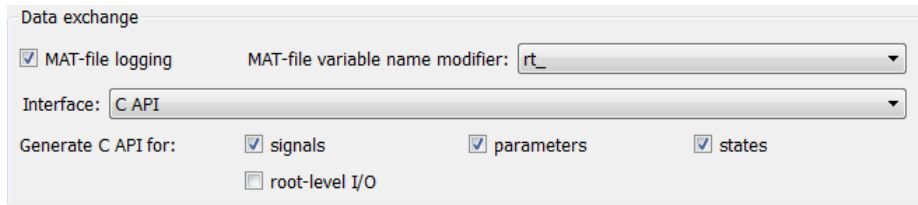

- 2 In the MATLAB Command Window, with the model open, specify the following command:

```
>> set_param(gcs, 'GenerateASAP2', 'on')
```

---

**Note** If you select both the C API and ASAP2 data interfaces, only the C API options are displayed in the Configuration Parameters dialog box.

---

- 3 Click **Generate** or **Build**. The code generator generates the following ASAP2 and C API files:

- *model.a21* — ASAP2 description file
- *model\_capi.c* — C API source file



- `model_capi.h` — C API header file

For more information about using the C API interface, see “Data Interchange Using the C API” on page 15-137.

## Direct Memory Access to Generated Code

The Simulink Coder product provides a TLC function library that lets you create a *global data map record*. The global data map record, when generated, is added to the `CompiledModel` structure in the `model.rtw` file. The global data map record is a database containing all information required for accessing memory in the generated code, including

- Signals (Block I/O)
- Parameters
- Data type work vectors (DWork)
- External inputs
- External outputs

Use of the global data map requires knowledge of the Target Language Compiler and of the structure of the `model.rtw` file. See “Target Language Compiler Overview” for information on these topics.

The TLC functions that are required to generate and access the global data map record are contained in `matlabroot/rtw/c/tlc/mw/globalmaplib.tlc`. The comments in the source code fully document the global data map structures and the library functions.

The global data map structures and functions might be modified or enhanced in future releases.



# Performance

---

- Chapter 16, “Optimizations for Generated Code”
- Chapter 17, “Defensive Programming”
- Chapter 18, “Data Copy Reduction”
- Chapter 19, “Execution Speed”
- Chapter 20, “Memory Usage”



# Optimizations for Generated Code

---

- “Optimization Parameters” on page 16-2
- “Advice About Optimizing Models for Code Generation” on page 16-5
- “Control Compiler Optimizations” on page 16-6
- “Optimization Tools and Techniques” on page 16-7
- “Control Memory Allocation for Time Counters” on page 16-9
- “Optimization Dependencies” on page 16-10

## Optimization Parameters

Many options on the **Optimization** and **Optimization > Signals and Parameters** panes of the Configuration Parameters dialog box affect generated code. The following figures shows the default optimization settings, except that **Inline parameters** and **Inline invariant signals**, which are cleared by default, are selected.

Simulation and code generation

- Block reduction
- Conditional input branch execution
- Implement logic signals as Boolean data (vs. double) Application lifespan (days)
- Use integer division to handle net slopes that are reciprocals of integers

Code generation

Data initialization

- Use memset to initialize floats and doubles to 0.0

Integer and fixed-point

- Remove code from floating-point to integer conversions that wraps out-of-range values
- Remove code from floating-point to integer conversions with saturation that maps NaN to zero

Accelerating simulations

Compiler optimization level:

- Verbose accelerator builds

Simulation and code generation

- Inline parameters
- Signal storage reuse

Code generation

- Enable local block outputs
- Reuse block outputs
- Eliminate superfluous local variables (expression folding)
- Inline invariant signals
- Minimize data copies between local and global variables
- Use memcpy for vector assignment Memcpy threshold (bytes):
- Loop unrolling threshold:  Maximum stack size (bytes):

Some basic optimization suggestions are given below, cross-referenced to more extensive relevant discussions in the documentation.

- Selecting the **Signal storage reuse** check box directs the Simulink Coder code generator to store signals in reusable memory locations. It also enables

the **Enable local block outputs**, **Reuse block outputs**, **Eliminate superfluous local variables (expression folding)**, and **Minimize data copies between local and global variables** options (see below).

Disabling **Signal storage reuse** makes all block outputs global and unique, which in many cases significantly increases RAM and ROM usage. See “Reduce Memory Requirements for Signals” on page 20-4 for more details.

- Selecting the **Inline parameters** check box reduces global RAM usage, because parameters are not declared in the global parameters structure. You can override the inlining of individual parameters by using the Model Parameter Configuration dialog box. You tune parameters used in referenced models differently, by declaring them as Model block parameter arguments, rather than using the Model Parameter Configuration dialog box. See “Inline Parameters” on page 19-2 and “Using Model Arguments” in the Simulink documentation for more details.
- Selecting the **Enable local block outputs** check box declares block signals locally in functions instead of being declared globally (when possible). You must select **Signal storage reuse** to enable **Enable local block outputs**. See “Declare Signals as Local Function Data” on page 18-17.
- Selecting the **Reuse block outputs** check box reduces stack size where signals are buffered in local variables. You must select **Signal storage reuse** to enable **Reuse block outputs**. See “Reuse Memory Allocated for Signals” on page 20-5.
- Selecting the **Inline invariant signals** check box makes the Simulink Coder code generator not generate code for blocks with a constant (invariant) sample time. You must select **Inline parameters** to enable **Inline invariant signals**. See “Inline Invariant Signals” on page 18-18.
- Selecting the **Eliminate superfluous local variables (expression folding)** check box minimizes the computation of intermediate results at block outputs and the storage of such results in temporary buffers or variables. See “Minimize Computations and Storage for Intermediate Results” on page 18-11.
- Selecting the **Minimize data copies between local and global variables** check box reuses existing global variables to store temporary results. You must select **Signal storage reuse** to enable **Minimize**

**data copies between local and global variables.** See “Reuse Memory Allocated for Signals” on page 20-5.

- Set a **Loop unrolling threshold**. The loop unrolling threshold determines when a wide signal should be wrapped into a `for` loop and when it should be generated as a separate statement for each element of the signal. See “Configure Loop Unrolling Threshold” on page 19-4 for details on this feature.
- Specifying a **Maximum stack size (bytes)** provides control of the number of local and global variables, which determine the amount of stack space required for an application. See “Use Stack Space Allocation” on page 20-6 for more information.
- If your target environment supports the `memcpy` function, and if your model uses signal vector assignments to move large amounts of data, selecting the **Use memcpy for vector assignment** check box can improve the execution speed of vector assignments by replacing `for` loops with `memcpy` function calls in the generated code. Set a **Memcpy threshold (bytes)**. See “Optimize Code Generated for Vector Assignments” on page 19-6 for details.

---

**Note** The `rtwdemos` example suite includes a set of models that illustrate optimization settings and techniques. To access these examples, type

`rtwdemos`

or click the above command. The MATLAB Help browser opens the Simulink Coder examples page. Click **Optimizations** in the navigation pane. Use the examples to learn about the specific effects that optimization parameters and techniques have on models.

---



## Advice About Optimizing Models for Code Generation

Using the Model Advisor, you can quickly analyze a model for code generation and identify aspects of your model that impede production deployment or limit code efficiency. You can select from a set of checks to run on a model's current configuration. The Model Advisor analyzes the model and generates check results providing suggestions for improvements in each area. Most Model Advisor diagnostics do not require the model to be in a compiled state; those that do are noted.

Before running the Model Advisor, select the target you plan to use for code generation. The Model Advisor works most effectively with ERT and ERT-based targets (targets based on the Embedded Coder software).

Use the following Model Advisor examples to investigate optimizing models for code generation using the Model Advisor:

- `rtwdemo_advisor1`
- `rtwdemo_advisor2`
- `rtwdemo_advisor3`

---

**Note** Example models `rtwdemo_advisor2` and `rtwdemo_advisor3` require Stateflow and Fixed-Point Toolbox software.

---

For more information on using the Model Advisor, see “Consult the Model Advisor” in the Simulink documentation. For more information about the checks in the Model Advisor, see “Embedded Coder Checks” in the Simulink Coder documentation.

## Control Compiler Optimizations

To control compiler optimizations for your Simulink Coder makefile build at the Simulink GUI level, use the **Compiler optimization level** parameter. The **Compiler optimization level** parameter provides

- Target-independent values `Optimizations on (faster runs)` and `Optimizations off (faster builds)`, which allow you to easily toggle compiler optimizations on and off during code development
- The value `Custom` for entering custom compiler optimization flags at the Simulink GUI level, rather than editing compiler flags into template makefiles (TMFs) or supplying compiler flags to Simulink Coder make commands

The default setting is `Optimizations off (faster builds)`. Selecting the value `Custom` enables the **Custom compiler optimization flags** field, in which you can enter custom compiler optimization flags (for example, `-O2`).

---

**Note** If you specify compiler options for your Simulink Coder makefile build using `OPT_OPTS`, `MEX_OPTS` (except `MEX_OPTS="-v"`), or `MEX_OPT_FILE`, the value of **Compiler optimization level** is ignored and a warning is issued about the ignored parameter.

---

For more information about the **Compiler optimization level** parameter and its values, see “Compiler optimization level” and “Custom compiler optimization flags”.

## Optimization Tools and Techniques

In addition to analyzing models with Model Advisor (see “Advice About Optimizing Models for Code Generation” on page 16-5), you can use a variety of other tools and techniques that work with any code format. Here are some particularly useful ones:

- Run the `slupdate` command to automatically convert older models (saved by prior versions or by the current one) to use current features. For details about what `slupdate` does, type

```
help slupdate
```

- Before building, set optimization flags for the compiler (for example, `-O2` for `gcc`, `-Ot` for the Microsoft Visual C++ compiler).
- Directly inline C/C++ S-functions into the generated code by writing a TLC file for the S-function. See “Generated S-Function Block” on page 12-34 and the Target Language Compiler documentation for more information on inlining S-functions.
- Use a Simulink data type other than `double` when possible. The available data types are `Boolean`, signed and unsigned 8-, 16-, and 32-bit integers, and 32- and 64-bit floats (a `double` is a 64-bit float). For more information, see “Data Types”. For a block-by-block summary, click `showblockdatatypetable` or type the command in the MATLAB Command Window.
- Remove repeated values in lookup table data.
- Use the Merge block to merge the output of signals wherever possible. This block is particularly helpful when you need to control the execution of function-call subsystems with a Stateflow chart. The following model shows an example of how to use the Merge block.

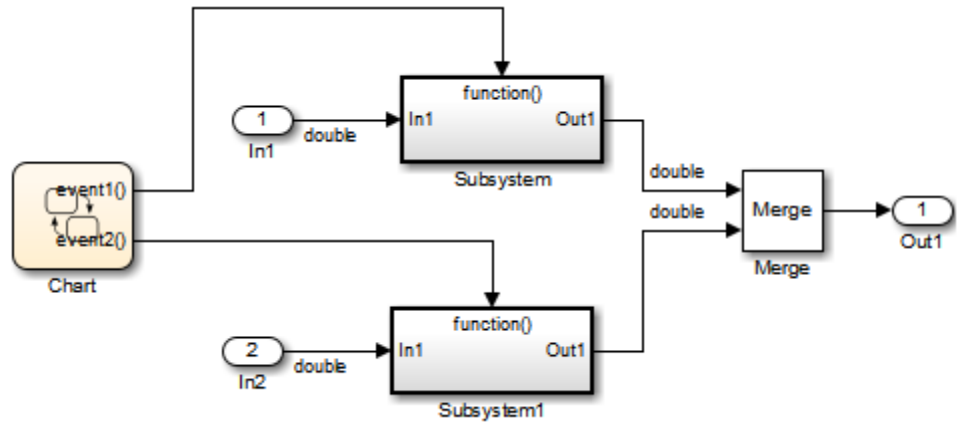

When more than one signal connected to a Merge block has a non-Auto storage class, all non-Auto signals connected to that block must *be identically labeled and have the same storage class*. When Merge blocks connect directly to one another, these rules apply to all signals connected to any of the Merge blocks in the group.

If you are licensed to use the Embedded Coder product, see also “Configure Code Optimizations” in the Embedded Coder documentation.

## Control Memory Allocation for Time Counters

The **Application lifespan (days)** parameter lets you control the allocation of memory for absolute and elapsed time counters. Such counters exist in the code for blocks that use absolute or elapsed time. For a list of such blocks, see “Limitations on the Use of Absolute Time” on page 1-88.

The size of the time counters in generated code is 8, 16, 32, or 64 bits. The size is set automatically to the minimum that can accommodate the duration value specified by **Application lifespan (days)** given the step size specified in the Configuration Parameters **Solver** pane. To minimize the amount of RAM used by time counters, specify the smallest lifespan possible and the largest step size possible.

An application runs to its specified lifespan. It may be able to run longer. For example, running a model with a step size of one millisecond (0.001 seconds) for one day requires a 32-bit timer, which could continue running without overflow for 49 days more.

To maximize application lifespan, specify **Application lifespan (days)** as `inf`. This value allocates 64 bits (two `uint32` words) for each timer. Using 64 bits to store timing data would allow a model with a step size of 0.001 microsecond (10E-09 seconds) to run for more than 500 years, which would rarely be required. 64-bit counters do not violate the usual Simulink Coder length limitation of 32 bits because the value of a time counter never provides the value of a signal, state, or parameter.

For information about the allocation and operation of absolute and elapsed time counters, see “Timers” on page 1-79. For information about asynchronous timing, see “Use Timers in Asynchronous Tasks” on page 1-58. For information about the effect of the **Application lifespan (days)** parameter on simulation, see “Application lifespan (days)” in the Simulink documentation.

## Optimization Dependencies

Several parameters available on the **Optimization** panes have dependencies on settings of other options. The following table summarizes the dependencies.

Option	Dependencies?	Dependency Details
<b>Block reduction</b>	No	
<b>Conditional input branch execution</b>	No	
<b>Implement logic signals as Boolean data (versus double)</b>	Yes	Disable for models created with a Simulink version that supports only signals of type double
<b>Signal storage reuse</b>	No	
<b>Inline parameters</b>	Yes	Disable for referenced models in a model reference hierarchy
<b>Application lifespan (days)</b>	No	
<b>Parameter structure (ERT targets only)</b>	Yes	Enabled by <b>Inline parameters</b>
<b>Enable local block outputs</b>	Yes	Enabled by <b>Signal storage reuse</b>
<b>Reuse block outputs</b>	Yes	Enabled by <b>Signal storage reuse</b>
<b>Inline invariant signals</b>	Yes	Enabled by <b>Inline parameters</b>
<b>Eliminate superfluous local variables (expression folding)</b>	Yes	Enabled by <b>Signal storage reuse</b>
<b>Pack Boolean data into bitfields (ERT targets only)</b>	No	
<b>Bitfield declarator type specifier (ERT targets only)</b>	Yes	Enabled by <b>Pack Boolean data into bitfields</b>
<b>Minimize data copies between local and global variables</b>	Yes	Enabled by <b>Signal storage reuse</b>
<b>Simplify array indexing (ERT targets only)</b>	No	
<b>Loop unrolling threshold</b>	No	

Option	Dependencies?	Dependency Details
Maximum stack size (bytes)	No	
Use memcpy for vector assignment	No	
Memcpy threshold (bytes)	Yes	Enabled by <b>Use memcpy for vector assignment</b>
Pass reusable subsystem output as (ERT targets only)	No	
Remove root level I/O zero initialization (ERT targets only)	No	
Use memset to initialize floats and doubles to 0.0	No	
Remove internal data zero initialization (ERT targets only)	No	
Optimize initialization code for model reference (ERT targets only)	Yes	Disable if model includes an enabled subsystem <i>and</i> the model is referred to from another model with a Model block
Remove code from floating-point to integer conversions that wrap out-of-range values	No	
Remove code from floating-point to integer conversions with saturation that maps NaN to zero	Yes (ERT targets) No (GRT targets)	For ERT targets, enabled by <b>Support floating-point numbers</b> and <b>Support non-finite numbers</b> in the <b>Code Generation &gt; Interface</b> pane
Remove code that protects against division arithmetic exceptions (ERT targets only)	No	





# Defensive Programming

---

- “Optimize Code for Floating-Point to Integer Conversions” on page 17-2
- “Disable Nonfinite Checks or Inlining for Math Functions” on page 17-4

## Optimize Code for Floating-Point to Integer Conversions

### In this section...

“Remove Code That Wraps Out-of-Range Values” on page 17-2

“Remove Code That Maps NaN to Integer Zero” on page 17-3

### Remove Code That Wraps Out-of-Range Values

Selecting the **Remove code from floating-point to integer conversions that wraps out-of-range values** check box in the **Integer and fixed-point** section of the **Optimization** pane causes the code generator to remove code that produces the same results as simulation when out-of-range conversions occur. This action reduces the size and increases the speed of generated code at the cost of potentially producing results that do not match simulation in the case of out-of-range values. For more information, see “Optimization Pane: General”.

The code generated for a conversion when you select the check box follows:

```
cg_in_0_20_0[i1] = (int32_T)((rtb_Switch[i1] + 9.0) / 0.09375);
```

The code generated for a conversion when you clear the check box follows:

```
_fixptlowering0 = (rtb_Switch[i1] + 9.0) / 0.09375;
_fixptlowering1 = fmod(_fixptlowering0 >= 0.0 ? floor(_fixptlowering0) :
    ceil(_fixptlowering0), 4.2949672960000000E+009);
if(_fixptlowering1 < -2.1474836480000000E+009) {
    _fixptlowering1 += 4.2949672960000000E+009;
} else if(_fixptlowering1 >= 2.1474836480000000E+009) {
    _fixptlowering1 -= 4.2949672960000000E+009;
}
cg_in_0_20_0[i1] = (int32_T)_fixptlowering1;
```

The code generator applies the `fmod` function to handle out-of-range conversion results.

## Remove Code That Maps NaN to Integer Zero

Selecting the **Remove code from floating-point to integer conversions with saturation that maps NaN to zero** check box in the **Integer and fixed-point** section of the **Optimization** pane causes the code generator to remove code that produces the same results as simulation when mapping from NaN to integer zero occurs. This action reduces the size and increases the speed of generated code at the cost of producing results that do not match simulation in the case of NaN values. For more information, see “Optimization Pane: General”.

The code generated for a conversion when you select the check box follows:

```
if (tmp < 2.147483648E+09) {
    if (tmp >= -2.147483648E+09) {
        tmp_0 = (int32_T)tmp;
    } else {
        tmp_0 = MIN_int32_T;
    }
} else {
    tmp_0 = MAX_int32_T;
}
```

The code generated for a conversion when you clear the check box follows:

```
if (tmp < 2.147483648E+09) {
    if (tmp >= -2.147483648E+09) {
        tmp_0 = (int32_T)tmp;
    } else {
        tmp_0 = MIN_int32_T;
    }
} else if (tmp >= 2.147483648E+09) {
    tmp_0 = MAX_int32_T;
} else {
    tmp_0 = 0;
}
```

## Disable Nonfinite Checks or Inlining for Math Functions

When Simulink Coder software generates code for math functions,

- If the model option **Support non-finite numbers** is selected, nonfinite number checking is generated uniformly for math functions, without the ability to specify that nonfinite number checking should be generated for some functions, but not for others.
- By default, inlining is applied uniformly for math functions, without the ability to specify that inlining should be generated for some functions, while invocations should be generated for others.

You can use code replacement library (CRL) customization entries to:

- Selectively disable nonfinite checks for math functions. This can improve the execution speed of the generated code.
- Selectively disable inlining of math functions. This can increase code readability and decrease code size.

The functions for which these customizations are supported include the following:

- Floating-point only: `atan2`, `ceil`, `copysign`, `fix`, `floor`, `hypot`, `log`, `log10`, `round`, `sincos`, and `sqrt`
- Floating-point and integer: `abs`, `max`, `min`, `mod`, `rem`, `saturate`, and `sign`

The general workflow for disabling nonfinite number checking and/or inlining is as follows:

- 1 If you can disable nonfinite number checking for a particular math function, or if you want to disable inlining for a particular math function and instead generate a function invocation, you can copy the following MATLAB function code into a MATLAB file with an `.m` file name extension, for example, `crl_table_customization.m`.

```
function hTable = crl_table_customization

% Create an instance of the Code Replacement Library table for controlling
```

```

% function intrinsic inlining and nonfinite support

hTable = RTW.Tf1Table;

% Inline - true (if function needs to be inline)
%           false (if function should not be inlined)
% SNF (support nonfinite) - ENABLE (if non-finite checking should be performed)
%                               DISABLE (if non-finite checking should NOT be performed)
%                               UNSPECIFIED (Default behavior)

% registerCustomizationEntry(hTable, ...
%           Priority, numInputs, key, inType, outType, Inline, SNF);

registerCustomizationEntry(hTable, ...
    100, 2, 'atan2', 'double', 'double', false, 'UNSPECIFIED');
registerCustomizationEntry(hTable, ...
    100, 2, 'atan2', 'single', 'single', false, 'UNSPECIFIED');

registerCustomizationEntry(hTable, ...
    100, 1, 'sincos', 'double', 'double', false, 'UNSPECIFIED');
registerCustomizationEntry(hTable, ...
    100, 1, 'sincos', 'single', 'single', false, 'UNSPECIFIED');

registerCustomizationEntry(hTable, ...
    100, 1, 'abs', 'double', 'double', true, 'UNSPECIFIED');
registerCustomizationEntry(hTable, ...
    100, 1, 'abs', 'single', 'single', true, 'UNSPECIFIED');

registerCustomizationEntry(hTable, ...
    100, 1, 'abs', 'int32', 'int32', true, 'UNSPECIFIED');
registerCustomizationEntry(hTable, ...
    100, 1, 'abs', 'int16', 'int16', true, 'UNSPECIFIED');
registerCustomizationEntry(hTable, ...
    100, 1, 'abs', 'int8', 'int8', true, 'UNSPECIFIED');
registerCustomizationEntry(hTable, ...
    100, 1, 'abs', 'integer', 'integer', true, 'UNSPECIFIED');
registerCustomizationEntry(hTable, ...
    100, 1, 'abs', 'uint32', 'uint32', true, 'UNSPECIFIED');
registerCustomizationEntry(hTable, ...
    100, 1, 'abs', 'uint16', 'uint16', true, 'UNSPECIFIED');

```

```
registerCustomizationEntry(hTable, ...
    100, 1, 'abs', 'uint8', 'uint8', true, 'UNSPECIFIED');

registerCustomizationEntry(hTable, ...
    100, 2, 'hypot', 'double', 'double', false, 'UNSPECIFIED');
registerCustomizationEntry(hTable, ...
    100, 2, 'hypot', 'single', 'single', false, 'UNSPECIFIED');

registerCustomizationEntry(hTable, ...
    100, 1, 'log', 'double', 'double', false, 'UNSPECIFIED');
registerCustomizationEntry(hTable, ...
    100, 1, 'log', 'single', 'double', false, 'UNSPECIFIED');

registerCustomizationEntry(hTable, ...
    100, 1, 'log10', 'double', 'double', false, 'UNSPECIFIED');
registerCustomizationEntry(hTable, ...
    100, 1, 'log10', 'single', 'double', false, 'UNSPECIFIED');

registerCustomizationEntry(hTable, ...
    100, 2, 'min', 'double', 'double', true, 'UNSPECIFIED');
registerCustomizationEntry(hTable, ...
    100, 2, 'min', 'single', 'single', true, 'UNSPECIFIED');
registerCustomizationEntry(hTable, ...
    100, 2, 'min', 'int32', 'int32', true, 'UNSPECIFIED');
registerCustomizationEntry(hTable, ...
    100, 2, 'min', 'int16', 'int16', true, 'UNSPECIFIED');
registerCustomizationEntry(hTable, ...
    100, 2, 'min', 'int8', 'int8', true, 'UNSPECIFIED');
registerCustomizationEntry(hTable, ...
    100, 2, 'min', 'uint32', 'uint32', true, 'UNSPECIFIED');
registerCustomizationEntry(hTable, ...
    100, 2, 'min', 'uint16', 'uint16', true, 'UNSPECIFIED');
registerCustomizationEntry(hTable, ...
    100, 2, 'min', 'uint8', 'uint8', true, 'UNSPECIFIED');
registerCustomizationEntry(hTable, ...
    100, 2, 'min', 'integer', 'integer', true, 'UNSPECIFIED');

registerCustomizationEntry(hTable, ...
    100, 2, 'max', 'double', 'double', true, 'UNSPECIFIED');
registerCustomizationEntry(hTable, ...
```

```
        100, 2, 'max', 'single', 'single', true, 'UNSPECIFIED');
registerCustomizationEntry(hTable, ...
        100, 2, 'max', 'int32', 'int32', true, 'UNSPECIFIED');
registerCustomizationEntry(hTable, ...
        100, 2, 'max', 'int16', 'int16', true, 'UNSPECIFIED');
registerCustomizationEntry(hTable, ...
        100, 2, 'max', 'int8', 'int8', true, 'UNSPECIFIED');
registerCustomizationEntry(hTable, ...
        100, 2, 'max', 'uint32', 'uint32', true, 'UNSPECIFIED');
registerCustomizationEntry(hTable, ...
        100, 2, 'max', 'uint16', 'uint16', true, 'UNSPECIFIED');
registerCustomizationEntry(hTable, ...
        100, 2, 'max', 'uint8', 'uint8', true, 'UNSPECIFIED');
registerCustomizationEntry(hTable, ...
        100, 2, 'max', 'integer', 'integer', true, 'UNSPECIFIED');

registerCustomizationEntry(hTable, ...
        100, 2, 'mod', 'double', 'double', false, 'UNSPECIFIED');
registerCustomizationEntry(hTable, ...
        100, 2, 'mod', 'single', 'single', false, 'UNSPECIFIED');
registerCustomizationEntry(hTable, ...
        100, 2, 'mod', 'int32', 'int32', false, 'UNSPECIFIED');
registerCustomizationEntry(hTable, ...
        100, 2, 'mod', 'int16', 'int16', false, 'UNSPECIFIED');
registerCustomizationEntry(hTable, ...
        100, 2, 'mod', 'int8', 'int8', false, 'UNSPECIFIED');
registerCustomizationEntry(hTable, ...
        100, 2, 'mod', 'uint32', 'uint32', false, 'UNSPECIFIED');
registerCustomizationEntry(hTable, ...
        100, 2, 'mod', 'uint16', 'uint16', false, 'UNSPECIFIED');
registerCustomizationEntry(hTable, ...
        100, 2, 'mod', 'uint8', 'uint8', false, 'UNSPECIFIED');

registerCustomizationEntry(hTable, ...
        100, 2, 'rem', 'double', 'double', false, 'UNSPECIFIED');
registerCustomizationEntry(hTable, ...
        100, 2, 'rem', 'single', 'single', false, 'UNSPECIFIED');
registerCustomizationEntry(hTable, ...
        100, 2, 'rem', 'int32', 'int32', false, 'UNSPECIFIED');
registerCustomizationEntry(hTable, ...
```

```
        100, 2, 'rem', 'int16', 'int16', false, 'UNSPECIFIED');
registerCustomizationEntry(hTable, ...
        100, 2, 'rem', 'int8', 'int8', false, 'UNSPECIFIED');
registerCustomizationEntry(hTable, ...
        100, 2, 'rem', 'uint32', 'uint32', false, 'UNSPECIFIED');
registerCustomizationEntry(hTable, ...
        100, 2, 'rem', 'uint16', 'uint16', false, 'UNSPECIFIED');
registerCustomizationEntry(hTable, ...
        100, 2, 'rem', 'uint8', 'uint8', false, 'UNSPECIFIED');

registerCustomizationEntry(hTable, ...
        100, 1, 'round', 'double', 'double', false, 'UNSPECIFIED');
registerCustomizationEntry(hTable, ...
        100, 1, 'round', 'single', 'single', false, 'UNSPECIFIED');

registerCustomizationEntry(hTable, ...
        100, 3, 'saturate', 'double', 'double', true, 'UNSPECIFIED');
registerCustomizationEntry(hTable, ...
        100, 3, 'saturate', 'single', 'single', true, 'UNSPECIFIED');
registerCustomizationEntry(hTable, ...
        100, 3, 'saturate', 'int32', 'int32', true, 'UNSPECIFIED');
registerCustomizationEntry(hTable, ...
        100, 3, 'saturate', 'int16', 'int16', true, 'UNSPECIFIED');
registerCustomizationEntry(hTable, ...
        100, 3, 'saturate', 'int8', 'int8', true, 'UNSPECIFIED');
registerCustomizationEntry(hTable, ...
        100, 3, 'saturate', 'uint32', 'uint32', true, 'UNSPECIFIED');
registerCustomizationEntry(hTable, ...
        100, 3, 'saturate', 'uint16', 'uint16', true, 'UNSPECIFIED');
registerCustomizationEntry(hTable, ...
        100, 3, 'saturate', 'uint8', 'uint8', true, 'UNSPECIFIED');
registerCustomizationEntry(hTable, ...
        100, 3, 'saturate', 'integer', 'integer', true, 'UNSPECIFIED');

registerCustomizationEntry(hTable, ...
        100, 1, 'sign', 'double', 'double', true, 'UNSPECIFIED');
registerCustomizationEntry(hTable, ...
        100, 1, 'sign', 'single', 'single', true, 'UNSPECIFIED');
registerCustomizationEntry(hTable, ...
        100, 1, 'sign', 'int32', 'integer', true, 'UNSPECIFIED');
```



```
registerCustomizationEntry(hTable, ...
    100, 1, 'sign', 'int16', 'integer', true, 'UNSPECIFIED');
registerCustomizationEntry(hTable, ...
    100, 1, 'sign', 'int8', 'integer', true, 'UNSPECIFIED');
registerCustomizationEntry(hTable, ...
    100, 1, 'sign', 'uint32', 'uint32', true, 'UNSPECIFIED');
registerCustomizationEntry(hTable, ...
    100, 1, 'sign', 'uint16', 'uint16', true, 'UNSPECIFIED');
registerCustomizationEntry(hTable, ...
    100, 1, 'sign', 'uint8', 'uint8', true, 'UNSPECIFIED');
registerCustomizationEntry(hTable, ...
    100, 1, 'sign', 'integer', 'integer', true, 'UNSPECIFIED');

registerCustomizationEntry(hTable, ...
    100, 1, 'sqrt', 'double', 'double', true, 'UNSPECIFIED');
registerCustomizationEntry(hTable, ...
    100, 1, 'sqrt', 'single', 'single', true, 'UNSPECIFIED');

registerCustomizationEntry(hTable, ...
    100, 1, 'ceil', 'double', 'double', true, 'UNSPECIFIED');
registerCustomizationEntry(hTable, ...
    100, 1, 'ceil', 'single', 'single', true, 'UNSPECIFIED');

registerCustomizationEntry(hTable, ...
    100, 1, 'floor', 'double', 'double', true, 'UNSPECIFIED');
registerCustomizationEntry(hTable, ...
    100, 1, 'floor', 'single', 'single', true, 'UNSPECIFIED');

registerCustomizationEntry(hTable, ...
    100, 1, 'fix', 'double', 'double', false, 'UNSPECIFIED');
registerCustomizationEntry(hTable, ...
    100, 1, 'fix', 'single', 'single', false, 'UNSPECIFIED');

registerCustomizationEntry(hTable, ...
    100, 1, 'copysign', 'double', 'double', true, 'UNSPECIFIED');
registerCustomizationEntry(hTable, ...
    100, 1, 'copysign', 'single', 'single', true, 'UNSPECIFIED');
```

- 2** To reduce the size of the file, you can delete the `registerCustomizationEntry` lines for functions for which the default nonfinite number checking and inlining behavior is acceptable.
- 3** For each remaining entry,
  - Set the `Inline` argument to `true` if the function should be inlined or `false` if it should not be inlined.
  - Set the `SNF` argument to `ENABLE` if nonfinite checking should be generated, `DISABLE` if nonfinite checking should not be generated, or `UNSPECIFIED` to accept the default behavior based on the model option settings.

Save the file.

- 4** Optionally, perform a quick check of the syntactic validity of the customization table entries by invoking the table definition file at the MATLAB command line (`>> tbl = crl_table_customization`). Fix syntax errors that are flagged.
- 5** Optionally, view the customization table entries in the Code Replacement Viewer (`>> RTW.viewTf1(crl_table_customization)`). For more information about viewing CRL tables, see “Selecting and Viewing Code Replacement Libraries” on page 9-61.
- 6** To register these changes and make them appear in the **Code replacement library** drop-down list located on the **Code Generation > Interface** pane of the Configuration Parameters dialog box, first copy the following MATLAB function code into an instance of the file `sl_customization.m`.

---

**Note** For the `RTW.Tf1Registry` instantiation shown below, specify the argument `'RTW'` if a GRT target is selected for your model, otherwise omit the argument.

---

```
function sl_customization(cm)
% sl_customization function to register a code replacement library (CRL)

% Register the CRL defined in local function locCrlRegFcn
cm.registerTargetInfo(@locCrlRegFcn);
```

```

end % End of SL_CUSTOMIZATION

% Local function to define a CRL containing crl_table_customization
function thisCrl = locCrlRegFcn

    % Instantiate a CRL registry entry - specify 'RTW' for GRT
    thisCrl = RTW.Tf1Registry('RTW');

    % Define the CRL properties
    thisCrl.Name = 'CRL Customization Example';
    thisCrl.Description = 'Example of CRL Customization';
    thisCrl.TableList = {'crl_table_customization'};
    thisCrl.BaseTf1 = 'C89/C90 (ANSI)';
    thisCrl.TargetHWDDeviceType = {'*'};

end % End of LOCCRLREGFCN

```

You can edit the `Name` field to determine what CRL name will appear in the **Code replacement library** drop-down list. Also, the file name in the `TableList` field must match the name of the file you created in step 1.

To register your changes, with both of the MATLAB files you created present in the MATLAB path, enter the following command in the MATLAB Command Window:

```
sl_refresh_customizations
```

- 7** Create or open a model that will generate function code corresponding to one of the math functions for which you specified a change in nonfinite number checking or inlining behavior.
- 8** Open the Configuration Parameters dialog box, go to the **Code Generation > Interface** pane, and use the **Code replacement library** drop-down list to select the CRL entry you registered in step 6, for example, `CRL Customization Example`.
- 9** Generate code for the model and examine the generated code to verify that the math functions are generated as expected.



# Data Copy Reduction

---

- “Optimizing Generated Code” on page 18-2
- “Generate Code Without Buffer Optimization” on page 18-4
- “Generate Code With Buffer Optimization” on page 18-9
- “Minimize Computations and Storage for Intermediate Results” on page 18-11
- “Declare Signals as Local Function Data” on page 18-17
- “Inline Invariant Signals” on page 18-18

## Optimizing Generated Code

### In this section...

“About Optimizing Generated Code” on page 18-2

“Setting Up the Model” on page 18-2

### About Optimizing Generated Code

This section shows how to configure optimizations and generate code for a model. It shows the generated code before and after the optimizations are applied.

---

**Note** You can view the code generated from this example using the MATLAB editor or by generating an HTML code generation report. For more information, see “Generate a Code Generation Report” on page 11-5.

---

The example model used, `example`, is shown below.



### Setting Up the Model

First, create the model from Simulink library blocks, and set up basic Simulink and Simulink Coder parameters as follows:

- 1 Create a folder, `example_codegen`, and make it your working folder:

```
!mkdir example_codegen
cd example_codegen
```

- 2 Create a new model and save it as `example`.
- 3 Add Sine Wave, Gain, and Out1 blocks to your model and connect them as shown in the preceding diagram. Label the signals as shown.

- 4** Open Model Explorer by selecting **Model Explorer** from the model's **View** menu.
- 5** In the **Model Hierarchy** pane, click the symbol preceding the model name to reveal its components.
- 6** Click **Configuration (Active)** in the left pane.
- 7** Select **Solver** in the center pane. The **Solver** pane appears at the right.
- 8** In the **Solver Options** pane:
  - a** Select **Fixed-step** in the **Type** field.
  - b** Select **discrete (no continuous states)** in the **Solver** field.
  - c** Specify **0.1** in the **Fixed-step size** field. (Otherwise, the Simulink Coder code generator posts a warning and supplies a default value when you generate code.)
- 9** Click **Apply**.
- 10** Click **Data Import/Export** in the center pane and make sure all check boxes in the right pane are cleared. Click **Apply** if you made any changes.
- 11** Select **Code Generation** in the center pane. Under **Target Selection** in the right pane, select the default generic real-time (GRT) target `grt.tlc`.
- 12** Select **Generate code only** at the bottom of the right pane. This option causes the Simulink Coder software to generate code and a make file, then stop at that point, rather than proceeding to invoke `make` to compile and link the code. Note that the label on the **Build** button changes to **Generate code**.
- 13** Click **Apply**.
- 14** Save the model.

## Generate Code Without Buffer Optimization

With buffer optimizations Simulink Coder software generates code that reduces memory consumption and execution time. In this example, you disable the buffer optimizations to see what the nonoptimized generated code looks like:

- 1 Select **Optimization** in the center pane and click the **Signals and Parameters** tab in the right pane. The **Signals and Parameters** pane appears at the right. Clear the **Signal storage reuse** option, as shown below. Change other attributes to match the figure.

---

**Note** Clearing the **Signal storage reuse** option disables the following options:

- **Enable local block outputs**
  - **Reuse block outputs**
  - **Eliminate superfluous local variables (expression folding)**
  - **Minimize data copies between local and global variables**
- 

The screenshot shows the configuration pane for 'Simulation and code generation' and 'Code generation'. The 'Simulation and code generation' section has two options: 'Inline parameters' (checked) and 'Signal storage reuse' (unchecked). The 'Code generation' section has several options: 'Enable local block outputs' (unchecked), 'Reuse block outputs' (unchecked), 'Eliminate superfluous local variables (expression folding)' (unchecked), 'Inline invariant signals' (unchecked), 'Minimize data copies between local and global variables' (unchecked), 'Use memcpy for vector assignment' (checked), 'Memcpy threshold (bytes): 64', 'Loop unrolling threshold: 5', and 'Maximum stack size (bytes): Inherit from target'.

- 2 Click **Apply**.
- 3 Select **Code Generation** in the center pane and click the **Report** tab on the right pane. The **Report** pane appears at the right.



- 4** Select the **Create code generation report** and **Open report automatically** check boxes. Selecting these check boxes makes the code generation report display after the build process completes.
- 5** Click **Apply**.
- 6** Select the **General** tab in the right pane and select **Generate code only**.
- 7** Click **Generate code**.

Because you selected the **Generate code only** option, the Simulink Coder build process does not invoke your make utility. The code generation process ends with this message:

```
### Successful completion of build procedure  
for model: example
```

- 8** The generated code is in the build folder, `example_grt_rtw`. The file `example_grt_rtw/example.c` contains the output computation for the model. You can view this file in the code generation report by clicking the `example.c` link in the left pane.
- 9** In `example.c`, find the function `example_output` near the top of the file.

The generated C code consists of procedures that implement the algorithms defined by your Simulink block diagram. The execution engine calls the procedures in succession as time moves forward. The modules that implement the execution engine and other capabilities are referred to collectively as the run-time interface modules. See the Simulink Coder User's Guide for a complete discussion of how the Simulink Coder software interfaces and executes application, system-dependent, and system-independent modules, in each of the two styles of generated code.

In code generated for example, the generated `example_output` function implements the actual algorithm for multiplying a sine wave by a gain. The `example_output` function computes the model's block outputs. The run-time interface must call `example_output` at every time step. With buffer optimizations turned off, `example_output` assigns unique buffers to each block output. These buffers (`rtB.sin_out`, `rtB.gain_out`) are members of a global block I/O data structure, called in this code `example_B` and declared as follows:

```
/* Block signals (auto storage) */
BlockIO_example example_B;
```

The data type `BlockIO_example` is defined in `example.h` as follows:

```
/* Block signals (auto storage) */
extern BlockIO_example example_B;
```

The output code accesses fields of this global structure, as shown below:

```
/* Model output function */
static void example_output(int_T tid)
{
    /* Sin: '<Root>/Sine Wave' */
    example_B.sin_out = sin(example_P.SineWave_Freq * example_M->Timing.t[0] +
        example_P.SineWave_Phase) * example_P.SineWave_Amp + example_P.SineWave_Bias;

    /* Gain: '<Root>/Gain' */
    example_B.gain_out = example_P.Gain_Gain * example_B.sin_out;

    /* Outport: '<Root>/Out1' */
    example_Y.Out1 = example_B.gain_out;

    /* tid is required for a uniform function interface.
     * Argument tid is not used in the function. */
    UNUSED_PARAMETER(tid);
}
```

- 10** In GRT targets such as this, the function `example_output` is called by a wrapper function, `Md1Outputs`. In `example.c`, find the function `Md1Outputs` near the end. It looks like this:

```
void Md1Outputs(int_T tid)
{
    example_output(tid);
}
```

---

**Note** In previous releases, `Md1Outputs` was the actual output function for code generated by all GRT-configured models. It is now implemented as a wrapper function to provide greater compatibility among different target configurations.

---



## Generate Code With Buffer Optimization

With buffer optimizations, Simulink Coder software generates code that reduces memory consumption and execution time. In this example, you turn buffer optimizations on and observe how they improve the code. Enable signal buffer optimizations and regenerate the code as follows:

- 1 Change your current working folder to `example_codegen` if you have not already done so.
- 2 In Model Explorer, select **Optimization** in the center pane and click the **Signals and Parameters** tab on the right pane. The **Signals and Parameters** pane appears at the right. Select the **Signal storage reuse** option.
- 3 Note that the following parameters become enabled in the **Code generation** section:
  - **Enable local block outputs**
  - **Reuse block outputs**
  - **Eliminate superfluous local variables (expression folding)**
  - **Minimize data copies between local and global variables**

Make sure that **Enable local block outputs**, **Reuse block outputs**, and **Minimize data copies between local and global variables** are selected, and that **Eliminate superfluous local variables (expression folding)** is cleared, as shown below.

The image shows two configuration panels from Simulink Coder. The top panel, titled "Simulation and code generation", contains a checkbox for "Inline parameters" (unchecked) with a "Configure ..." button, and a checked checkbox for "Signal storage reuse". The bottom panel, titled "Code generation", contains several options: "Enable local block outputs" (checked), "Reuse block outputs" (checked), "Eliminate superfluous local variables (expression folding)" (unchecked), "Inline invariant signals" (unchecked), "Minimize data copies between local and global variables" (checked), "Use memcpy for vector assignment" (checked), "Memcpy threshold (bytes):" with a text input field containing "64", "Loop unrolling threshold:" with a text input field containing "5", and "Maximum stack size (bytes):" with a dropdown menu set to "Inherit from target".

You will observe the effects of expression folding later in this example. Not performing expression folding allows you to see the effects of the buffer optimizations.

**4** Click **Apply** to apply the new settings.

**5** Select **Code Generation** in the center pane, and click **Generate code** on the right.

As before, the Simulink Coder software generates code in the `example_grt_rtw` folder. The previously generated code is overwritten.

**6** View `example.c` and examine the `example_output` function.

With buffer optimizations enabled, the code in `example_output` reuses the `example_Y.Out1` global buffer.

```
/* Model output function */
static void example_output(int_T tid)
{
    /* Sin: '<Root>/Sine Wave' */
    example_Y.Out1 = sin(example_P.SineWave_Freq * example_M->Timing.t[0] +
                        example_P.SineWave_Phase) * example_P.SineWave_Amp +
                    example_P.SineWave_Bias;

    /* Gain: '<Root>/Gain' */
    example_Y.Out1 = example_P.Gain_Gain * example_Y.Out1;

    /* tid is required for a uniform function interface.
     * Argument tid is not used in the function. */
    UNUSED_PARAMETER(tid);
}
```

This code is more efficient in terms of memory usage and execution speed. By eliminating a global variable and a data copy instruction, the data section is smaller and the code is smaller and faster. The efficiency improvement gained by selecting **Enable local block outputs**, **Reuse block outputs**, and **Minimize data copies between local and global variables** is more significant in a large model with many signals.

# Minimize Computations and Storage for Intermediate Results

## In this section...

“About Expression Folding” on page 18-11

“Expression Folding Example” on page 18-12

“Enable Expression Folding” on page 18-15

## About Expression Folding

*Expression folding* is a code optimization technique that minimizes the computation of intermediate results at block outputs and the storage of such results in temporary buffers or variables. **Eliminate superfluous local variables (expression folding)** is used to enable expression folding. When expression folding is on, the Simulink Coder code generator collapses, or “folds,” block computations into a single expression, instead of generating separate code statements and storage declarations for each block in the model.

Expression folding can dramatically improve the efficiency of generated code, frequently achieving results that compare favorably to hand-optimized code. In many cases, entire groups of model computations fold into a single highly optimized line of code.

By default, expression folding is on. The Simulink Coder code generation options are configured to use expression folding wherever possible. Most Simulink blocks support expression folding.

You can also take advantage of expression folding in your own inlined S-function blocks. See “Write S-Functions That Support Expression Folding” on page 14-91 for information on how to do this.

In the code generation examples that follow, the **Signal storage reuse** optimizations (**Enable local block outputs**, **Reuse block outputs**, **Eliminate superfluous local variables (expression folding)** and **Minimize data copies between local and global variables**) are all turned on.

## Expression Folding Example

As a simple example of how expression folding affects the code generated from a model, consider the following model.

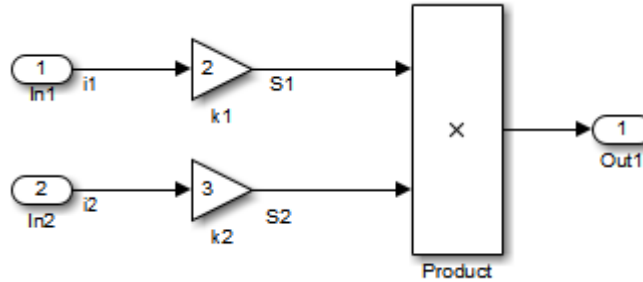

With expression folding on, this model generates a single-line output computation, as shown in this `model_output` function.

```

static void exprfld_output(int_T tid)
{
    /* Output: '<Root>/Out1' incorporates:
     * Gain: '<Root>/k1'
     * Gain: '<Root>/k2'
     * Inport: '<Root>/In1'
     * Inport: '<Root>/In2'
     * Product: '<Root>/Product'
     */
    exprfld_Y.Out1 = exprfld_U.i1 * exprfld_P.k1_Gain *
        (exprfld_U.i2 * exprfld_P.k2_Gain);
}
  
```

The generated comments indicate the block computations that were combined into a single expression. The comments also document the block parameters that appear in the expression.

With expression folding off, the same model computes temporary results for both Gain blocks before the final output, as shown in this output function:

```

static void exprfld_output(int_T tid)
  
```



```
{  
  
    real_T rtb_S2;  
  
    /* Gain: '<Root>/k1' incorporates:  
     * Inport: '<Root>/In1'  
     */  
    exprfld_Y.Out1 = exprfld_U.i1 * exprfld_P.k1_Gain  
  
    /* Gain: '<Root>/k2' incorporates:  
     * Inport: '<Root>/In2'  
     */  
    rtb_S2 = exprfld_U.i2 * exprfld_P.k2_Gain;  
  
    /* Product: '<Root>/Product' */  
    exprfld_Y.Out1 = exprfld_Y.Out1 * rtb_S2;  
}
```

Turn on expression folding, a code optimization technique that minimizes the computation of intermediate results and the use of temporary buffers or variables.

Enable expression folding and regenerate the code as follows:

- 1 Change your current working folder to `example_codegen` if you have not already done so.
- 2 In Model Explorer, select **Optimization** in the center pane and click the **Signals and Parameters** tab on the right pane. The **Signals and Parameters** pane appears at the right.

- 3** Select the **Eliminate superfluous local variables (expression folding)** option.

Simulation and code generation

Inline parameters Configure ...  Signal storage reuse

---

Code generation

Enable local block outputs  Reuse block outputs

Eliminate superfluous local variables (expression folding)  Inline invariant signals

Minimize data copies between local and global variables

Use memcpy for vector assignment Memcpy threshold (bytes):

Loop unrolling threshold:  Maximum stack size (bytes):

- 4** Click **Apply**.

- 5** Select **Code Generation** in the center pane, and click **Generate code** on the right.

The Simulink Coder software generates code as before.

- 6** View `example.c` and examine the function `example_output`.

In the previous examples, the Gain block computation was computed in a separate code statement and the result was stored in a temporary location before the final output computation.

With **Eliminate superfluous local variables (expression folding)** selected, there is a subtle but significant difference in the generated code: the gain computation is incorporated (or folded) directly into the Outport computation, eliminating the temporary location and separate code statement. This computation is on the last line of the `example_output` function.

```
/* Model output function */
static void example_output(int_T tid)
{
    /* Outport: '<Root>/Out1' incorporates:
     * Gain: '<Root>/Gain'
     * Sin: '<Root>/Sine Wave'
    */
}
```

```

*/
example_Y.Out1 = (sin(example_P.SineWave_Freq * example_M->Timing.t[0] +
                    example_P.SineWave_Phase) * example_P.SineWave_Amp +
                example_P.SineWave_Bias) * example_P.Gain_Gain;

/* tid is required for a uniform function interface.
* Argument tid is not used in the function. */
UNUSED_PARAMETER(tid);
}

```

In many cases, expression folding can incorporate entire model computations into a single, highly optimized line of code. Expression folding is turned on by default. Using this option will improve the efficiency of generated code.

For an example of expression folding in the context of a more complex model, click `rtwdemo_slexprfold`, or type the following command at the MATLAB prompt.

```
rtwdemo_slexprfold
```

## Enable Expression Folding

Expression folding operates only on expressions involving local variables. Expression folding is therefore available only when the **Signal storage reuse** code generation option is on.

For a new model, default code generation options are set to use expression folding. If you are configuring an existing model, enable expression folding as follows:

- 1** Open the Configuration Parameters dialog box and select the **Optimization > Signals and Parameters** pane.
- 2** Select the **Signal storage reuse** check box.
- 3** Select the **Enable local block outputs** check box.
- 4** Select the **Reuse block outputs** check box.
- 5** Select the **Minimize data copies between local and global variables** check box.

**6** Enable expression folding by selecting **Eliminate superfluous local variables (expression folding)**.

All expression folding related options are now selected.

**7** Click **Apply**.

## Declare Signals as Local Function Data

To declare block signals locally in functions instead of being declared globally (when possible), select the **Enable local block outputs** configuration parameter. This parameter is available only when you select **Signal storage reuse**.

For more information on the use of the **Enable local block outputs** option, see “Signals” on page 7-52.

## Inline Invariant Signals

An invariant signal is a block output signal that does not change during Simulink simulation. For example, the signal S3 in this block diagram is an invariant signal.

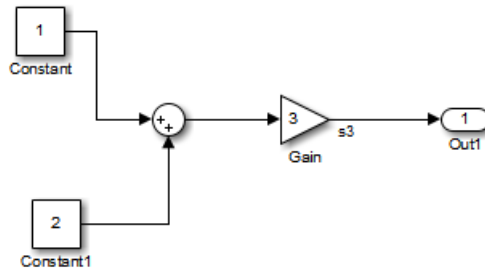

For the previous model, if you select **Inline invariant signals** on the **Optimization > Signals and Parameters** pane, the Simulink Coder code generator inlines the invariant signal S3 in the generated code.

Note that an *invariant signal* is not the same as an *invariant constant*. In the preceding example, the two constants (1 and 2) and the gain value of 3 are invariant constants. To inline these invariant constants, select **Inline parameters**.

---

**Note** If your model contains Model blocks, **Inline parameters** must be *on* for all referenced models. If a referenced model does not have **Inline Parameters** set to *on*, the Simulink engine temporarily enables this option while generating code for the referenced model, then turns it off again when the build completes. Thus the referenced model is left in its previous state and need not be resaved. For the top model, **Inline parameters** can be either *on* or *off*.

---

# Execution Speed

---

- “Inline Parameters” on page 19-2
- “Configure Loop Unrolling Threshold” on page 19-4
- “Optimize Code Generated for Vector Assignments” on page 19-6
- “Generate Target Optimizations Within Algorithm Code” on page 19-10

## Inline Parameters

When you select the **Inline parameters** configuration parameter:

- The Simulink Coder code generator uses the numerical values of model parameters, instead of their symbolic names, in generated code.

If the value of a parameter is a workspace variable, or an expression including one or more workspace variables, the variable or expression is evaluated at code generation time. The hard-coded result value appears in the generated code. An inlined parameter, because it has in effect been transformed into a constant, is no longer tunable. That is, it is not visible to externally written code, and its value cannot be changed at runtime.

- The **Configure** button becomes enabled. Clicking the **Configure** button opens the Model Parameter Configuration dialog box.

The Model Parameter Configuration dialog box lets you remove individual parameters from inlining and declare them to be tunable variables (or global constants). When you declare a parameter tunable, the Simulink Coder product generates a storage declaration that allows the parameter to be interfaced to externally written code. This enables your hand-written code to change the value of the parameter at run-time.

The Model Parameter Configuration dialog box lets you improve overall efficiency by inlining most parameters, while at the same time retaining the flexibility of run-time tuning for selected parameters.

See “Parameters” on page 7-10 for more information on interfacing parameters to externally written code.

**Inline parameters** also instructs the Simulink engine to propagate constant sample times. The engine computes the output signals of blocks that have constant sample times once during model startup. This improves performance because such blocks do not compute their outputs at every time step of the model.

You can select the **Inline invariant signals** code generation option (which also places constant values in generated code) only when **Inline parameters** is *on*. See “Inline Invariant Signals” on page 18-18.



## Referenced Models

When a top model uses referenced models or if a model is referenced by another model:

- All referenced models must specify **Inline parameters** to be on
- The top model can specify **Inline parameters** to be on or off.

When the top model specifies **Inline parameters** to be on, you cannot use the Model Parameter Configuration dialog box to tune parameters that are passed to referenced models. To tune such parameters, you must declare them in the referenced model's workspace, and then pass run-time values (or expressions) for them in argument lists specified for each Model block that references that model. For more information, see "Using Model Arguments".

## Configure Loop Unrolling Threshold

The **Loop unrolling threshold** parameter on the **Optimization > Signals and Parameters** pane determines when a wide signal or parameter should be wrapped into a for loop and when it should be generated as a separate statement for each element of the signal. The default threshold value is 5.

For example, consider the model below:



The gain parameter of the Gain block is the vector `myGainVec`.

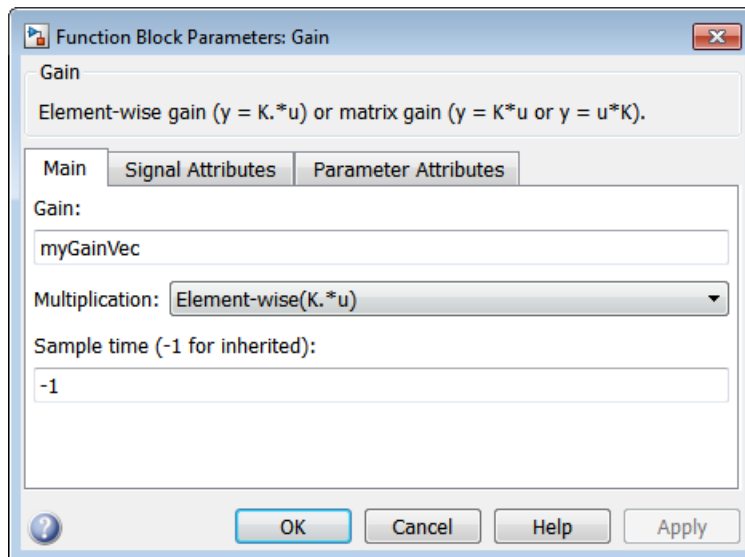

Assume that the loop unrolling threshold value is set to the default, 5.

If `myGainVec` is declared as

```
myGainVec = [1:10];
```

an array of 10 elements, `myGainVec_P.Gain_Gain[]`, is declared within the `Parameters_model` data structure. The size of the gain array exceeds the loop unrolling threshold. Therefore, the code generated for the Gain block iterates over the array in a for loop, as shown in the following code:

```
{
    int32_T i1;

    /* Gain: '<Root>/Gain' */
    for(i1=0; i1<10; i1++) {
        myGainVec_B.Gain_f[i1] = rtb_foo *
            myGainVec_P.Gain_Gain[i1];
    }
}
```

If `myGainVec` is declared as

```
myGainVec = [1:3];
```

an array of three elements, `myGainVec_P.Gain_Gain[]`, is declared within the `Parameters` data structure. The size of the gain array is below the loop unrolling threshold. The generated code consists of inline references to each element of the array, as in the code below.

```
/* Gain: '<Root>/Gain' */
myGainVec_B.Gain_f[0] = rtb_foo * myGainVec_P.Gain_Gain[0];
myGainVec_B.Gain_f[1] = rtb_foo * myGainVec_P.Gain_Gain[1];
myGainVec_B.Gain_f[2] = rtb_foo * myGainVec_P.Gain_Gain[2];
```

See “Explore Variable Names and Loop Rolling” for more information on loop rolling.

---

**Note** When a model includes Stateflow charts or MATLAB Function blocks, you can apply a set of Stateflow optimizations on the **Optimization > Stateflow** pane. The settings you select for the Stateflow options also apply to all MATLAB Function blocks in the model. This is because the MATLAB Function blocks and Stateflow charts are built on top of the same technology and share a code base. You do not need a Stateflow license to use MATLAB Function blocks.

---

## Optimize Code Generated for Vector Assignments

### In this section...

“Configure Model to Optimize Code Generated for Vector Assignments” on page 19-6

“Optimize Code Generated for Vector Assignments Using memcpy” on page 19-7

### Configure Model to Optimize Code Generated for Vector Assignments

The **Use memcpy for vector assignment** option lets you optimize generated code for vector assignments by replacing for loops with memcpy function calls. The memcpy function can be more efficient than for-loop controlled element assignment for large data sets. Where memcpy offers improved execution speed, you can also use this model option to specify that the generated code use memcpy when assigning a vector signal.

Selecting the **Use memcpy for vector assignment** option enables the associated parameter **Memcpy threshold (bytes)**, which allows you to specify the minimum array size in bytes for which memcpy function calls should replace for loops in the generated code. For more information, see “Use memcpy for vector assignment” and “Memcpy threshold (bytes)”.

In considering whether to use this optimization,

- Verify that your target supports the memcpy function.
- Determine whether your model uses signal vector assignments (such as  $Y=expression$ ) to move large amounts of data, for example, using the Selector block.

To apply this optimization,

- 1 Consider first generating code without this optimization and measuring its execution, to establish a baseline for evaluating the optimized assignment.
- 2 Select **Use memcpy for vector assignment** and examine the setting of **Memcpy threshold (bytes)**, which by default specifies 64 bytes as the

minimum array size for which for loops are replaced with memcpy function calls. Based on the array sizes used in your application's signal vector assignments, and any target environment considerations that might bear on the threshold selection, accept the default or specify another array size.

- 3 Generate code, and measure its execution speed against your baseline or previous iterations. Iterate on steps 2 and 3 until you achieve an optimal result.

---

**Note** The memcpy optimization may not occur under certain conditions, including when other optimizations have a higher precedence than the memcpy optimization, or when the generated code is originating from Target Language Compiler (TLC) code, such as a TLC file associated with an S-function block.

---



---

**Note** If you are licensed for Embedded Coder software, you can use a code replacement library (CRL) to provide your own custom implementation of the memcpy function to be used in generated model code. For more information, see “Map memcpy Function to Target-Specific Implementations”.

---

## Optimize Code Generated for Vector Assignments Using memcpy

To examine the effect on generated vector assignment code of using the **Use memcpy for vector assignment** option, perform the following steps:

- 1 Create a model that generates signal vector assignments. For example,
  - a Use In, Out, and Mux blocks to create the following model.

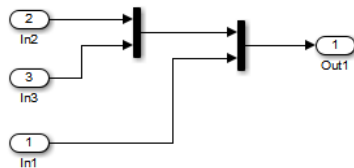

- b Select the diagram and use **Edit > Subsystem** to make it a subsystem.

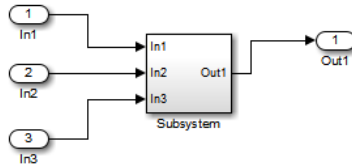

- c Open Model Explorer and configure the **Signal Attributes** for the In1, In2, and In3 source blocks. For each, set **Port dimensions** to [1,100], and set **Data type** to int32. Apply the changes.
  - d Go to the **Optimization > Signals and Parameters** pane of the Configuration Parameters dialog box and clear the **Use memcopy for vector assignment** option. Apply the changes and save the model. In this example, the model is saved to the name `vectorassign`.
- 2 Go to the **Code Generation > Report** pane of the Configuration Parameters dialog box and select the **Create code generation report**. Then go to the **Code Generation** pane, select the **Generate code only** option, and generate code for the model. When code generation completes, the HTML code generation report is displayed.
  - 3 In the HTML code generation report, click on the `vectorassign.c` section and inspect the model output function. Notice that the vector assignments are implemented using for loops.

```

/* Model output function */
static void vectorassign_output(void)
{
    int32_T i;

    /* Output: '<Root>/Out1' incorporates:
     * Inport: '<Root>/In1'
     * Inport: '<Root>/In2'
     * Inport: '<Root>/In3'
     */
    for (i = 0; i < 100; i++) {
        vectorassign_Y.Out1[i] = vectorassign_U.In2[i];
    }

    for (i = 0; i < 100; i++) {
        vectorassign_Y.Out1[i + 100] = vectorassign_U.In3[i];
    }
}

```

```

}

for (i = 0; i < 100; i++) {
    vectorassign_Y.Out1[i + 200] = vectorassign_U.In1[i];
}

/* End of Outport: '<Root>/Out1' */

```

- 4 Go to the **Optimization > Signals and Parameters** pane of the Configuration Parameters dialog box and select the **Use memcpy for vector assignment** option. Leave the **Memcpy threshold (bytes)** option at its default setting of 64 Apply the changes and regenerate code for the model. When code generation completes, the HTML code generation report again is displayed.
- 5 In the HTML code generation report, click on the `vectorassign.c` section and inspect the model output function. Notice that the vector assignments now are implemented using `memcpy` function calls.

```

/* Model output function */
static void vectorassign_output(void)
{
    int32_T i;

    /* Outport: '<Root>/Out1' incorporates:
     * Inport: '<Root>/In1'
     * Inport: '<Root>/In2'
     * Inport: '<Root>/In3'
     */
    memcpy(&vectorassign_Y.Out1[0], &vectorassign_U.In2[0], 100U * sizeof(int32_T));
    memcpy(&vectorassign_Y.Out1[100], &vectorassign_U.In3[0], 100U * sizeof(int32_T));
    memcpy(&vectorassign_Y.Out1[200], &vectorassign_U.In1[0], 100U * sizeof(int32_T));
}

```

## Generate Target Optimizations Within Algorithm Code

Some application components are hardware-specific and cannot simulate on a host system. For example, consider a component that includes pragmas and assembly code for enabling hardware instructions for saturate on add operations or a Fast Fourier Transform (FFT) function.

The following table lists integration options to customize generated algorithm code with target-specific optimizations.

---

**Note** Solutions marked with *EC only* require an Embedded Coder license.

---

If...	Then...	For More Information, See
You want to optimize target performance (speed and memory) of model code by replacing default math functions and operators with target-specific code	<i>EC only</i> — Implement function and operator replacements by using the code replacement library (CRL) API, Code Replacement Tool, and Code Replacement Viewer to create, examine, validate, and register hardware-specific replacement tables	<ul style="list-style-type: none"> <li>• <code>rtwdemo_crl_script</code></li> <li>• “Introduction to Code Replacement Libraries”</li> </ul>
You want to control how code generation technology declares, stores, and represents signals, tunable parameters, block states, and data objects in generated code	<i>EC only</i> — Design (create) and apply custom storage classes	<ul style="list-style-type: none"> <li>• <code>rtwdemo_cscpredef</code></li> <li>• <code>rtwdemo_importstruct</code></li> <li>• <code>rtwdemo_advsc</code></li> <li>• “Custom Storage Classes”</li> </ul>



---

**Note** To simulate an algorithm that includes target-specific elements in a host environment, you must create code that is equivalent to the target code and can run in the host environment.

---



# Memory Usage

---

- “Minimize Memory Requirements During Code Generation” on page 20-2
- “Implement Logic Signals as Boolean Data” on page 20-3
- “Reduce Memory Requirements for Signals” on page 20-4
- “Reuse Memory Allocated for Signals” on page 20-5
- “Use Stack Space Allocation” on page 20-6

## Minimize Memory Requirements During Code Generation

When the Simulink Coder product generates code, it creates an intermediate representation of your model (called *model.rtw*), which the Target Language Compiler parses to transform block computations, parameters, signals, and constant data into a high-level language, (for example, C). Parameters and data are normally copied into the *model.rtw* file, whether they originate in the model itself or come from variables or objects in a workspace.

Models which have large amounts of parameter and constant data (such as lookup tables) can tax memory resources and slow down code generation because of the need to copy their data to *model.rtw*. You can improve code generation performance by limiting the size of data that is copied by using a `set_param` command, described below.

Data vectors such as those for parameters, lookup tables, and constant blocks whose sizes exceed a specified value are not copied into the *model.rtw* file. In place of the data vectors, the code generator places a special reference key in the intermediate file that enables the Target Language Compiler to access the data directly from the Simulink software and format it directly into the generated code. This results in maintaining only one copy of large data vectors in memory.

You can specify the maximum number of elements that a parameter or other data source can have for the Simulink Coder code generator to represent it literally in the *model.rtw* file. Whenever this threshold size is exceeded, the product writes a reference to the data to the *model.rtw* file, rather than its values. The default threshold value is 10 elements, which you can verify with

```
get_param(0, 'RTWDataReferencesMinSize')
```

To set the threshold to a different value, type the following `set_param` function in the MATLAB Command Window:

```
set_param(0, 'RTWDataReferencesMinSize', <size>)
```

Provide an integer value for `size` that specifies the number of data elements above which reference keys are to be used in place of actual data values.

## Implement Logic Signals as Boolean Data

When you select the **Implement logic signals as Boolean data (vs. double)** check box, blocks that generate logic signals output Boolean signals. When you clear this check box, blocks that generate logic signals output double signals.

The check box is selected by default because it reduces memory requirements (a Boolean signal typically requires one byte in memory while a double signal requires eight bytes in memory). Clear this check box for compatibility with models created using earlier versions of Simulink that support only double signals. For details about this check box, see “Implement logic signals as Boolean data (vs. double)”.

## Reduce Memory Requirements for Signals

To instruct the Simulink Coder code generator to reuse signal memory, which can reduce memory requirements of your real-time program, select the configuration parameter **Signal storage reuse**. Disabling **Signal storage reuse** makes all block outputs global and unique, which in many cases significantly increases RAM and ROM usage.

For more details on the **Signal storage reuse** option, see “Signals” on page 7-52.

---

**Note** Selecting **Signal storage reuse** also enables the **Enable local block outputs**, **Reuse block outputs**, **Eliminate superfluous local variables (expression folding)**, and **Minimize data copies between local and global variables** options on the **Optimization > Signals and Parameters** pane. See “Declare Signals as Local Function Data” on page 18-17 and “Reuse Memory Allocated for Signals” on page 20-5.

---

## Reuse Memory Allocated for Signals

Two parameters provide the capability to reuse memory allocated for signals: **Reuse block output** and **Minimize data copies between local and global variables**.

Selecting **Reuse block output** directs the code generator to reuse signal memory. When **Reuse block output** is cleared, signals are stored in unique locations.

**Reuse block output** is enabled only when you select **Signal storage reuse**.

Selecting **Minimize data copies between local and global variables** reuses existing global variables to store temporary results. Clearing **Minimize data copies between local and global variables** writes data for block outputs to local variables. You must select **Signal storage reuse** to enable **Minimize data copies between local and global variables**.

See “Signals” on page 7-52 for more information (including generated code example) on **Reuse block output**, **Minimize data copies between local and global variables**, and other signal storage options.

## Use Stack Space Allocation

Your application might be constrained by limited memory. Controlling the maximum allowable size for the stack is one way to modify whether data is defined as local or global in the generated code. You can limit the use of stack space by specifying a positive integer value for the “Maximum stack size (bytes)” parameter, on the **Optimization > Signals and Parameters** pane of the Configuration parameter dialog box. Specifying the maximum allowable stack size provides control over the number of local and global variables in the generated code. Specifically, lowering the maximum stack size might generate more variables into global structures. The number of local and global variables help determine the required amount of stack space for execution of the generated code.

The default setting for “Maximum stack size (bytes)” is `Inherit from target`. In this case, the value of the maximum stack size is the smaller value of the following: the default value set by the Simulink Coder software (200,000 bytes) or the value of the TLC variable `MaxStackSize` found in the system target file (`ert.tlc`).

To specify a smaller stack size for your application, select the `Specify a value` option of the **Maximum stack size (bytes)** parameter and enter a positive integer value. To specify a smaller stack size at the command line, use:

```
set_param(model_name, 'MaxStackSize', 65000);
```

---

**Note** For overall executable stack usage metrics, you might want to do a target-specific measurement, such as using runtime (empirical) analysis or static (code path) analysis with object code.

---

It is recommended that you use the **Maximum stack size (bytes)** parameter to control stack space allocation instead of modifying the TLC variable, `MaxStackSize`, in the system target file. However, a target author might want to set the TLC variable, `MaxStackSize`, for a target. To set `MaxStackSize`, use `assign` statements in the system target file (`ert.tlc`), as in the following example.



```
%assign MaxStackSize = 4096
```

Write your %assign statements in the Configure RTW code generation settings section of the system target file. The %assign statement is described in “Target Language Compiler”.



# Verification

---



# Simulation and Code Comparison

---

- “Comparing Output Data” on page 21-2
- “Configure Signal Data for Logging” on page 21-3
- “Log Simulation Data” on page 21-5
- “Log Data from the Generated Program” on page 21-7
- “Compare Numerical Results” on page 21-9

### Comparing Output Data

This example shows you how to verify the answers computed by code generated from the `sldemo_f14` model. It shows how to capture two sets of output data and compare the sets. Simulating the model produces one set of output data. Executing the generated code produces a second set of output data.

---

**Note** To obtain a valid comparison between the outputs of the model and the generated code, use the same **Solver options** and the same **Step size** for both the simulation run and the build process. You must configure the model to save simulation time.

---

For an example, see “Configure Signal Data for Logging” on page 21-3.

## Configure Signal Data for Logging

Configure the model for logging and recording signal data.

- 1 Make sure that `sldemo_f14` is closed. Clear the MATLAB workspace to eliminate the results of previous simulation runs. At the MATLAB prompt, type:

```
clear
```

The clear operation clears variables created during previous simulations and all workspace variables, some of which are standard variables that the `sldemo_f14` model requires.

- 2 Open the model by entering `sldemo_f14` at the MATLAB command line.
- 3 In the model window, choose **File > Save As**, navigate to the working folder, and save a copy of the `sldemo_f14` model as `myf14`.
- 4 Set up your model to log signal data for signals: `Stick`, `alpha,rad`, and `NzPilot,g`. For each signal, follow these steps.
  - a Right-click the signal and select **Properties** from the context menu.
  - b In the Signal Properties dialog box, select **Log signal Data**.
  - c In the **Logging name** section, in the drop-down list, select **Custom**. In the field, enter the logging name for the corresponding signal.

Signal Name	Logging Name
<code>Stick</code>	<code>Stick_input</code>
<code>alpha,rad</code>	<code>Angle_of_attack</code>
<code>NzPilot,g</code>	<code>Pilot_G_force</code>

- d Click **Apply** and **OK**.

For information on how to log signal data, see “Export Signal Data Using Signal Logging”.

- 5 Select **Simulation > Model Configuration Parameters** to open the Configuration Parameters dialog box.

- 6 Select the **Solver** pane. In the **Solver options** section, specify the **Type** parameter as **Fixed-step**.
- 7 On the **Data Import/Export** pane:
  - Specify the **Format** parameter as **Structure with time**.
  - Select the **Signal logging** parameter.
  - Select the **Record and inspect simulation output** parameter. When you select this parameter, on the Simulink Editor window, the **Record** button is now on.
- 8 Save the model.

Proceed to “Log Simulation Data” on page 21-5.



## Log Simulation Data

Run the simulation, log the signal data, and view the data in the Simulation Data Inspector.

- 1 Run the model. When the simulation is done, the Simulation Data Inspector opens. You can also open the Simulation Data Inspector from the Simulink Editor toolbar. Click the **Record** button arrow, and select **Simulation Data Inspector**.
- 2 Right-click Run1: myf14. In the context menu, select Group Signals. Specify the Group Signals settings.

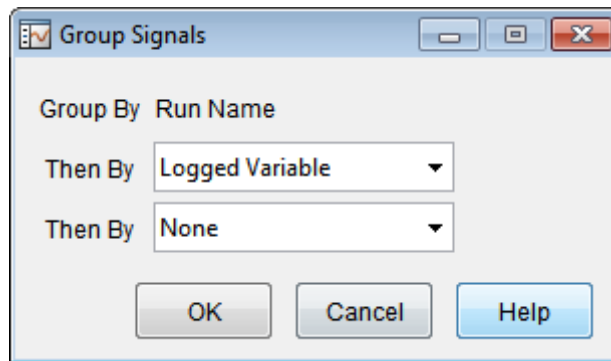

- 3 Click the Run1: myf14 expander to view the logged variables. Then click the logouts expander and then the expanders for each logged signal.
- 4 On the right pane, on the **View** toolbar, click **Show Details**.
- 5 In the **Layout** column, click the field that displays 1x1. A plot matrix opens. To create a view of 4 plots, select the 2x2 matrix.
- 6 Select **Hide Details**.
- 7 For each signal:
  - a Click a plot, which will then show a blue border.
  - b Select the check box next to a logged signal name.

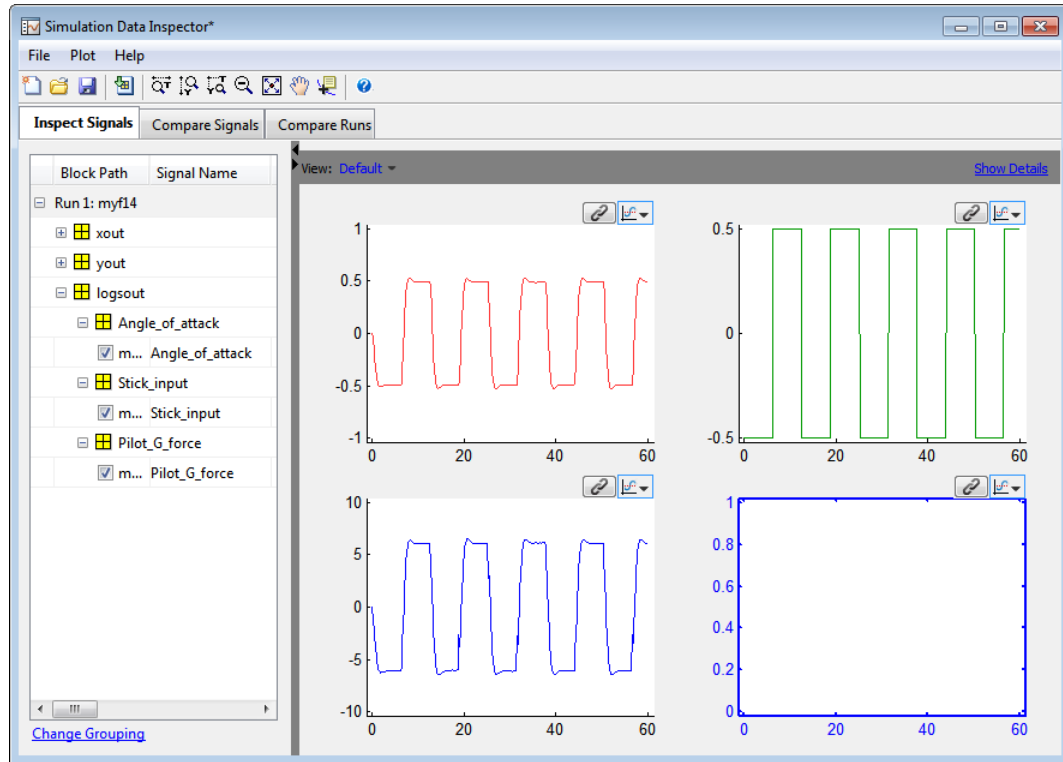

The next task is to “Log Data from the Generated Program” on page 21-7.

## Log Data from the Generated Program

Because you have modified the model, you must rebuild and run the myf14 executable to obtain a valid data file.

- 1** Select **Simulation > Model Configuration Parameters** to open the Configuration Parameters dialog box.
- 2** Select the **Code Generation > Interface** pane.
- 3** Set the **MAT-file variable name modifier** menu to `rt_`. Doing so prefixes `rt_` to each variable that you selected to be logged in the first part of this example.
- 4** Click **Apply** and **OK**.
- 5** Save the model.
- 6** To generate code, on the Simulink Editor toolbar, click the **Build Model** button. Status messages in the MATLAB Command Window track the build process.
- 7** When the build is finished, run the standalone program from MATLAB.

```
!myf14
```

The executing program writes the following messages to the MATLAB Command Window.

```
** starting the model **  
** created myf14.mat **
```

- 8** Load the data file `myf14.mat`.

```
load myf14
```

- 9** To view the two execution outputs, `alpha`, `rad` and `NzPilot`, `g`, import the data into the Simulation Data Inspector:
  - a** In the Simulation Data Inspector, select **File > Import Data** to open the Data Import dialog box.

- b** Specify **Import from** as **Base workspace**. Specify **Import to** as **New run**.
- c** Click **Clear All** to clear all of the check boxes. Select the check box for data where the **Time Series Root** is `rt_yout` and the **Block Path** is `myf14/alpha, rad` and `myf14/NzPilot, g`.
- d** Click **OK**.

The selected data is now under **Run2: Imported\_Data**.

Block Path	Signal Name	Line	Data Source	Model	Abs Tol	Rel Tol
Run 1: myf14						
+	xout					
+	yout					
-	logsout					
-	Angle_of_attack					
	<input checked="" type="checkbox"/> m... Angle_of_attack	—	logsout.get...	myf14	0	0
-	Stick_input					
	<input checked="" type="checkbox"/> m... Stick_input	—	logsout.get...	myf14	0	0
-	Pilot_G_force					
	<input checked="" type="checkbox"/> m... Pilot_G_force	—	logsout.get...	myf14	0	0
Run 2: Imported_Data						
-	rt_yout					
	<input checked="" type="checkbox"/> myf14... alpha, rad	.....	rt_yout.sign...	myf14	0	0
	<input checked="" type="checkbox"/> myf14... NzPilot, g	.....	rt_yout.sign...	myf14	0	0

- 10** On the **Inspect Signals** tab, you can view this data by selecting the **Plot** button for each output.

Proceed to “Compare Numerical Results” on page 21-9.

## Compare Numerical Results

You have now obtained data from a Simulink run of the model and from a run of the program generated from the model. In the Simulation Data Inspector, select the **Compare Signals** tab. Your comparison results might differ from these results.

To compare alpha, rad, under **Run 1**, in the **Sig 1** column, select Angle\_of\_attack. Under **Run 2**, in the **Sig 2** column, select alpha, rad. The **Signals** plot shows the data. The difference is calculated and plotted in the **Difference** plot.

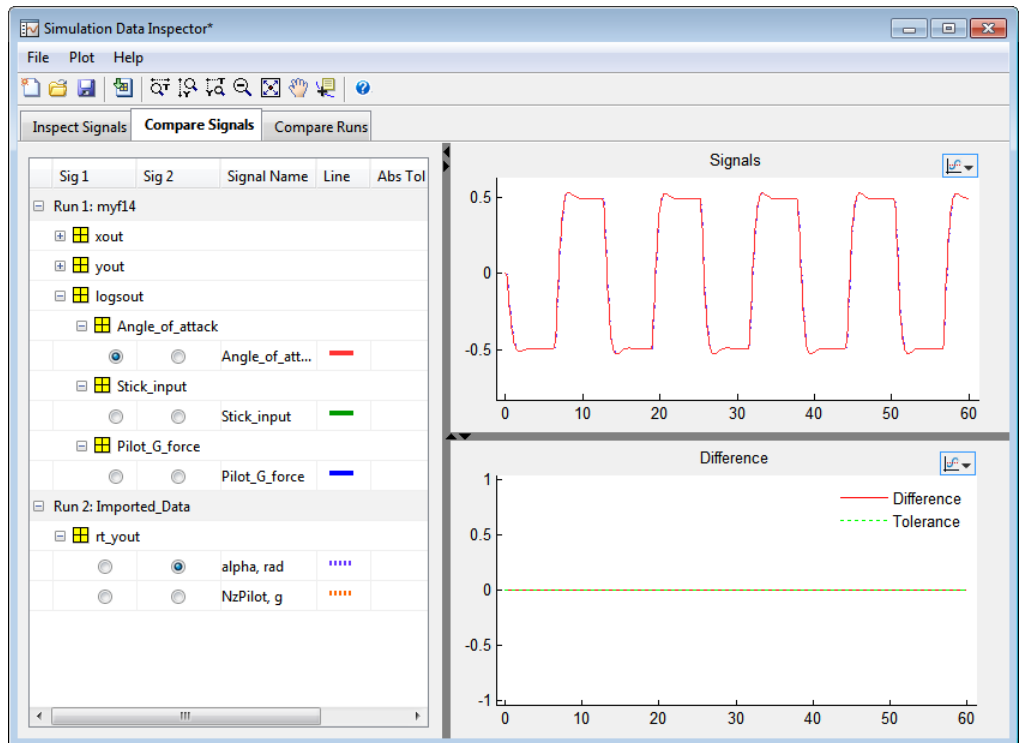

To compare NzPilot,g, under **Run 1**, in the **Sig 1** column, select Pilot\_G\_force. Under **Run 2**, in the **Sig 2** column, select NzPilot,g. The **Signals** plot shows the data.

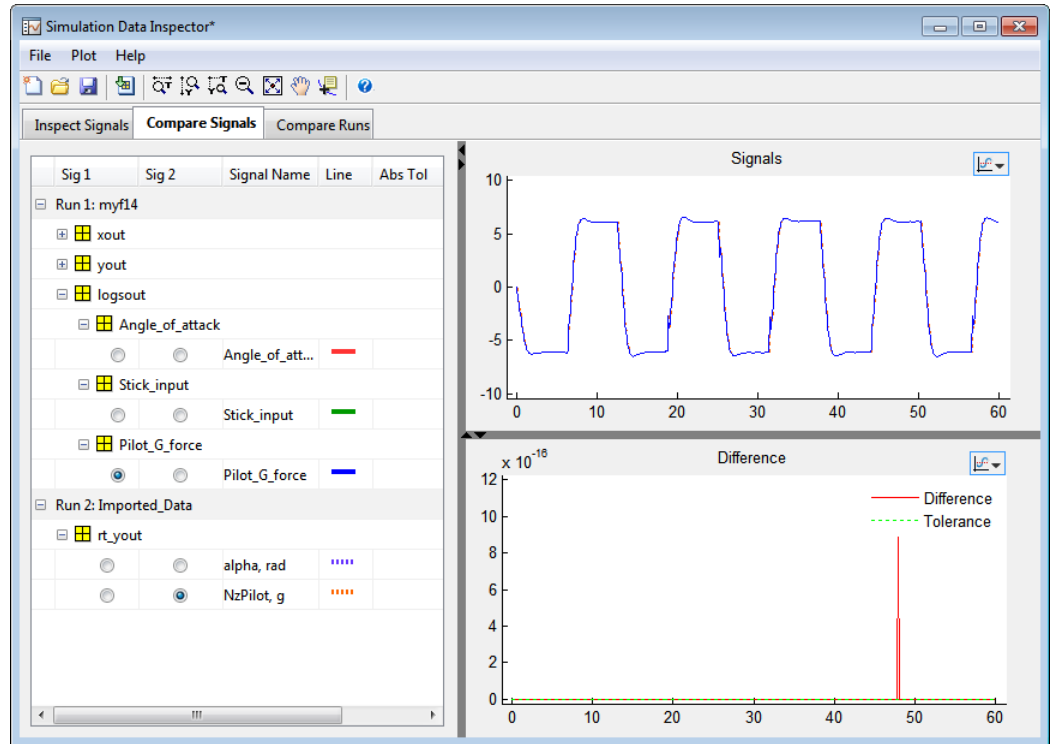

Overall agreement is within  $10^{-16}$ . The means of residuals are an order of magnitude smaller. This slight error can be caused by many factors, including:

- Different compiler optimizations
- Statement ordering
- Run-time libraries

For example, a function call such as `sin(2.0)` might return a slightly different value depending on which C library you are using. Such variations can also cause differences between your results and these results.

# Customization

---

- Chapter 22, “Build Process Integration”
- Chapter 23, “Run-Time Data Interface Extensions”
- Chapter 24, “Custom Target Development”





# Build Process Integration

---

- “Control Build Process Compiling and Linking” on page 22-2
- “Cross-Compile Code Generated on Microsoft Windows” on page 22-4
- “Control Library Location and Naming During Build” on page 22-7
- “Recompile Precompiled Libraries” on page 22-12
- “Customize Post-Code-Generation Build Processing” on page 22-13
- “Configure Generated Code with TLC” on page 22-18
- “Customize Build Process with STF\_make\_rtw\_hook File” on page 22-21
- “Customize Build Process with sl\_customization.m” on page 22-28
- “Replace the STF\_rtw\_info\_hook Mechanism” on page 22-33
- “Customize Build to Use Shared Utility Code” on page 22-34

## Control Build Process Compiling and Linking

After generating code for a model, the Simulink Coder build process determines whether or not to compile and link an executable program. This decision is governed by the following:

- **Generate code only** option

When you select this option, the Simulink Coder software generates code for the model, including a makefile.

- **Generate makefile** option

When you clear this option, the Simulink Coder software does not generate a makefile for the model. You must specify any post code generation processing, including compilation and linking, as a user-defined command, as explained in “Customize Post-Code-Generation Build Processing” on page 22-13.

- **Makefile-only target**

The Microsoft Visual C++ Project Makefile versions of the `grt`, `grt_malloc`, and Embedded Coder target configurations generate a Visual C++ project makefile (*model.mak*). To build an executable, you must open *model.mak* in the Visual C++ IDE and compile and link the model code.

- **HOST template makefile variable**

The template makefile variable `HOST` identifies the type of system upon which your executable is intended to run. The variable can be set to one of three possible values: `PC`, `UNIX`, or `ANY`.

By default, `HOST` is set to `UNIX` in template makefiles designed for use with The Open Group UNIX platforms (such as `grt_unix.tmf`), and to `PC` in the template makefiles designed for use with development systems for the PC (such as `grt_vc.tmf`).

If the Simulink software is running on the same type of system as that specified by the `HOST` variable, then the executable is built. Otherwise,

- If `HOST = ANY`, an executable is still built. This option is useful when you want to cross-compile a program for a system other than the one the Simulink software is running on.

- Otherwise, processing stops after generating the model code and the makefile; the following message is displayed on the MATLAB command line.

```
### Make will not be invoked - template makefile is for a different host
```

- TGT\_FCN\_LIB template makefile variable

The template makefile variable TGT\_FCN\_LIB specifies compiler command line options. The line in the makefile is TGT\_FCN\_LIB = |>TGT\_FCN\_LIB<|. By default, the Simulink Coder software expands the |>TGT\_FCN\_LIB<| token to match the setting of the **Code replacement library** option on the **Code Generation > Interface** pane of the Configuration Parameters dialog box. Possible values for this option include ANSI\_C, C99 (ISO), GNU99 (GNU), and C++ (ISO). You can use this token in a makefile conditional statement to specify compiler options to be used. For example, if you set the token to C99 (ISO), the compiler might need an additional option set to support C99 library functions.

## Cross-Compile Code Generated on Microsoft Windows

If you need to generate code with the Simulink Coder software on a Microsoft Windows system but compile the generated code on a different supported platform, you can do so by modifying your TMF and model configuration parameters. For example, you would need to do this if you develop applications with the MATLAB and Simulink products on a Windows system, but you run your generated code on a Linux system.

To set up a cross-compilation development environment, do the following (here a Linux system is the destination platform):

- 1 On your Windows system, copy the UNIX TMF for your target to a local folder. This will be your working folder for initiating code generation. For example, you might copy `matlabroot/rtw/c/grt/grt_unix.tmf` to `D:/work/my_grt_unix.tmf`.
- 2 Make the following changes to your copy of the TMF:
  - Add the following line near the `SYS_TARGET_FILE =` line:

```
MAKEFILE_FILESEP = /
```
  - Search for the line `'ifeq ($(OPT_OPTS),$(DEFAULT_OPT_OPTS))'` and, for each occurrence, remove the conditional logic and retain only the `'else'` code. That is, remove everything from the `'if'` to the `'else'`, inclusive, as well as the closing `'endif'`. Only the lines from the `'else'` portion should remain. This forces the run-time libraries to build for a Linux system.
- 3 Open your model and make the following changes in the **Code Generation** pane of the Configuration Parameters dialog:
  - Specify the name of your new TMF in the **Template makefile** text box (for example, `my_grt_unix.tmf`).
  - Select **Generate code only** and click **Apply**.
- 4 Generate the code.
- 5 If the build folder (folder from which the model was built) is not already Linux accessible, copy it to a Linux accessible path. For example, if your

build folder for the generated code was `D:\work\mymodel_grt_rtw`, copy that entire folder tree to a path such as `/home/user/mymodel_grt_rtw`.

- 6 If the MATLAB folder tree on the Windows system is Linux accessible, skip this step. Otherwise, you must copy all the include and source folders to a Linux accessible drive partition, for example, `/home/user/myinstall`. These folders appear in the makefile after `MATLAB_INCLUDES =` and `ADD_INCLUDES =` and can be found by searching for `$(MATLAB_ROOT)`. Any path that contains `$(MATLAB_ROOT)` must be copied. Here is an example list (your list will vary depending on your model):

```
$(MATLAB_ROOT)/rtw/c/grt
$(MATLAB_ROOT)/extern/include
$(MATLAB_ROOT)/simulink/include
$(MATLAB_ROOT)/rtw/c/src
$(MATLAB_ROOT)/rtw/c/tools
```

Additionally, paths containing `$(MATLAB_ROOT)` in the build rules (lines with `%.o :`) must be copied. For example, based on the build rule

```
%.o : $(MATLAB_ROOT)/rtw/c/src/ext_mode/tcpip/%.c
```

the following folder should be copied:

```
$(MATLAB_ROOT)/rtw/c/src/ext_mode/tcpip
```

---

**Note** The path hierarchy relative to the MATLAB root must be maintained. For example, `c:\MATLAB\rtw\c\tools\*` would be copied to `/home/user/mlroot/rtw/c/tools/*`.

For some blocksets, it is easiest to copy a higher-level folder that includes the subfolders listed in the makefile. For example, the DSP System Toolbox product requires the following folders to be copied:

```
$(MATLAB_ROOT)/toolbox/dspblks
$(MATLAB_ROOT)/toolbox/rtw/dspblks
```

---

- 7 Make the following changes to the generated makefile:

- Set both `MATLAB_ROOT` and `ALT_MATLAB_ROOT` equal to the Linux accessible path to *matlabroot* (for example, `home/user/myinstall`).
- Set `COMPUTER` to the computer value for your platform, such as `GLNX86`. Enter `help computer` in the MATLAB Command Window for a list of computer values.
- In the `ADD_INCLUDES` list, change the build folder (designating the location of the generated code on the Windows system) and parent folders to Linux accessible include folders. For example, change `D:\work\mymodel_grt_rtw\` to `/home/user/mymodel_grt_rtw`.

Additionally, if *matlabroot* is a UNC path, such as `\\my-server\myapps\matlab`, replace the hard-coded MATLAB root with `$(MATLAB_ROOT)`.

- 8 From a Linux shell, compile the code you generated on the Windows system. You can do this by running the generated *model.bat* file or by typing the make command line as it appears in the *.bat* file.

---

**Note** If errors occur during makefile execution, you may need to run the `dos2unix` utility on the makefile (for example, `dos2unix mymodel.mk`).

---

## Control Library Location and Naming During Build

Two configuration parameters, `TargetPreCompLibLocation` and `TargetLibSuffix`, are available for you to use to control values placed in Simulink Coder generated makefiles during the token expansion from template makefiles (TMFs). You can use these parameters to

- Specify the location of precompiled libraries, such as blockset libraries or the Simulink Coder library. Typically, a target has cross-compiled versions of these libraries and places them in a target-specific folder.
- Control the suffix applied to library file names (for example, `_target.a` or `_target.lib`).

Targets can set the parameters inside the system target file (STF) select callback. For example:

```
function mytarget_select_callback_handler(varargin)
    hDig=varargin{1};
    hSrc=varargin{2};
    slConfigUISetVal(hDig, hSrc,...
    'TargetPreCompLibLocation', 'c:\mytarget\precomplibs');
    slConfigUISetVal(hDig, hSrc, 'TargetLibSuffix',...
    '_diab.library');
```

The TMF has corresponding expansion tokens:

```
|>EXPAND_LIBRARY_LOCATION<|
|>EXPAND_LIBRARY_SUFFIX<|
```

Alternatively, you can use a call to the `set_param` function. For example:

```
set_param(model, 'TargetPreCompLibLocation', ...
'c:\mytarget\precomplibs');
```

---

**Note** If your model contains referenced models, you can use the make option `USE_MDLREF_LIBPATHS` to control whether libraries used by the referenced models are copied to the parent model's build folder. For more information, see “Control the Location of Model Reference Libraries” on page 22-9.

---

## Specify the Location of Precompiled Libraries

Use the `TargetPreCompLibLocation` configuration parameter to:

- Override the precompiled library location specified in the `rtwmakecfg.m` file (see “Use `rtwmakecfg.m` API to Customize Generated Makefiles” on page 14-124 for details)
- Precompile and distribute target-specific versions of product libraries (for example, the DSP System Toolbox product)

For a precompiled library, such as a blockset library or the Simulink Coder library, the location specified in `rtwmakecfg.m` is typically a location specific to the blockset or the Simulink Coder product. It is expected that the library will exist in this location and it is linked against during Simulink Coder builds.

However, for some applications, such as custom targets, it is preferable to locate the precompiled libraries in a target-specific or other alternate location rather than in the location specified in `rtwmakecfg.m`. For a custom target, the library is expected to be created using the target-specific cross-compiler and placed in the target-specific location for use during the Simulink Coder build process. All libraries intended to be supported by the target should be compiled and placed in the target-specific location.

You can set up the `TargetPreCompLibLocation` parameter in its select callback. The path that you specify for the parameter must be a fully qualified absolute path to the library location. Relative paths are not supported. For example:

```
slConfigUISetVal(hDlg, hSrc, 'TargetPreCompLibLocation',...
'c:\mytarget\precomplibs');
```

Alternatively, you set the parameter with a call to the `set_param` function. For example:

```
set_param(model, 'TargetPreCompLibLocation',...
'c:\mytarget\precomplibs');
```

During the TMF-to-makefile conversion, the Simulink Coder build process replaces the token `|>EXPAND_LIBRARY_LOCATION<|` with the specified location in the `rtwmakecfg.m` file. For example, if the library name specified in the `rtwmakecfg.m` file is `'rtwlib'`, the TMF expands from:



```
LIBS += |>EXPAND_LIBRARY_LOCATION<| \ |>EXPAND_LIBRARY_NAME<| \  
|>EXPAND_LIBRARY_SUFFIX<|
```

to:

```
LIBS += c:\mytarget\precomplibs\rtwlib_diab.library
```

By default, `TargetPreCompLibLocation` is an empty string and the Simulink Coder build process uses the location specified in `rtwmakecfg.m` for the token replacement.

## Control the Location of Model Reference Libraries

On platforms other than the Apple Macintosh platform, when building a model that uses referenced models, the Simulink Coder build process by default:

- Copies libraries used by the referenced models to the parent model's build folder
- Assigns the filenames of the libraries to `MODELREF_LINK_LIBS` in the generated makefile

For example, if a model includes a referenced model `sub`, the Simulink Coder build process assigns the library name `sub_rtwlib.lib` to `MODELREF_LINK_LIBS` and copies the library file to the parent model's build folder. This definition is then used in the final link line, which links the library into the final product (usually an executable). This technique minimizes the length of the link line.

On the Macintosh platform, and optionally on other platforms, the Simulink Coder build process:

- Does not copy libraries used by the referenced models to the parent model's build folder
- Assigns the relative paths and filenames of the libraries to `MODELREF_LINK_LIBS` in the generated makefile

When using this technique, the Simulink Coder build process assigns a relative path such as `../slprj/grt/sub/sub_rtwlib.lib` to `MODELREF_LINK_LIBS` and uses the path to gain access to the library file at link time.

To change to the non-default behavior on platforms other than the Macintosh platform, enter the following command in the **Make command** field of the **Code Generation** pane of the Configuration Parameters dialog box:

```
make_rtw USE_MDLREF_LIBPATHS=1
```

If you specify other Make command arguments, such as `OPTS="-g"`, you can specify the multiple arguments in any order.

To return to the default behavior, set `USE_MDLREF_LIBPATHS` to 0, or remove it.

## Control the Suffix Applied to Library File Names

Use the `TargetLibSuffix` configuration parameter to control the suffix applied to library names (for example, `_target.lib` or `_target.a`). The specified suffix string must include a period (.). You can apply `TargetLibSuffix` to the following libraries:

- Libraries on which a target depends, as specified in the `rtwmakecfg.m` API. You can use `TargetLibSuffix` to affect the suffix of both precompiled and non-precompiled libraries configured from the `rtwmakecfg` API. For details, see “Use `rtwmakecfg.m` API to Customize Generated Makefiles” on page 14-124.

In this case, a target can set the parameter in its select callback. For example:

```
slConfigUISetVal(hDlg, hSrc, 'TargetLibSuffix', ...  
'_diab.library');
```

Alternatively, you can use a call to the `set_param` function. For example:

```
set_param(model, 'TargetLibSuffix', '_diab.library');
```

During the TMF-to-makefile conversion, the Simulink Coder build process replaces the token `|>EXPAND_LIBRARY_SUFFIX<|` with the specified suffix. For example, if the library name specified in the `rtwmakecfg.m` file is `'rtwlib'`, the TMF expands from:

```
LIBS += |>EXPAND_LIBRARY_LOCATION<| \ |>EXPAND_LIBRARY_NAME<| \  
|>EXPAND_LIBRARY_SUFFIX<|
```

to:

```
LIBS += c:\mytarget\precomplibs\rtwlib_diab.library
```

By default, `TargetLibSuffix` is set to an empty string. In this case, the Simulink Coder build process replaces the token `|>EXPAND_LIBRARY_SUFFIX<|` with an empty string.

- Shared utility library and the model libraries created with model reference. For these cases, associated makefile variables do not require the `|>EXPAND_LIBRARY_SUFFIX<|` token. Instead, the Simulink Coder build process includes `TargetLibSuffix` implicitly. For example, for a top model named `topmodel` with submodels named `submodel1` and `submodel2`, the top model's TMF is expanded from:

```
SHARED_LIB          = |>SHARED_LIB<|
MODELLIB            = |>MODELLIB<|
MODELREF_LINK_LIBS = |>MODELREF_LINK_LIBS<|
```

to:

```
SHARED_LIB          = \
..\slprj\ert\_sharedutils\rtwshared_diab.library
MODELLIB            = topmodellib_diab.library
MODELREF_LINK_LIBS = \
submodel1_rtwlib_diab.library submodel2_rtwlib_diab.library
```

By default, the `TargetLibSuffix` parameter is an empty string. In this case, the Simulink Coder build process chooses a default suffix for these three tokens using a file extension of `.lib` on Windows hosts and `.a` on UNIX hosts. (For model reference libraries, the default suffix additionally includes `_rtwlib`.) For example, on a Windows host, the expanded makefile values would be:

```
SHARED_LIB          = ..\slprj\ert\_sharedutils\rtwshared.lib
MODELLIB            = topmodellib.lib
MODELREF_LINK_LIBS = submodel1_rtwlib.lib submodel2_rtwlib.lib
```

## Recompile Precompiled Libraries

You can recompile precompiled libraries included as part of the Simulink Coder product, such as `rtwlib` or `dsplib`, by using a supplied MATLAB function, `rtw_precompile_libs`. You might consider doing this if you need to customize compiler settings for various platforms or environments. For details on using `rtw_precompile_libs`, see “Precompile S-Function Libraries” on page 14-129.

## Customize Post-Code-Generation Build Processing

The Simulink Coder product provides a set of tools, including a build information object, you can use to customize build processing that occurs after code generation. You might use such customizations for target development or the integration of third-party tools into your application development environment. The next figure and the steps that follow show the general workflow for setting up such customizations.

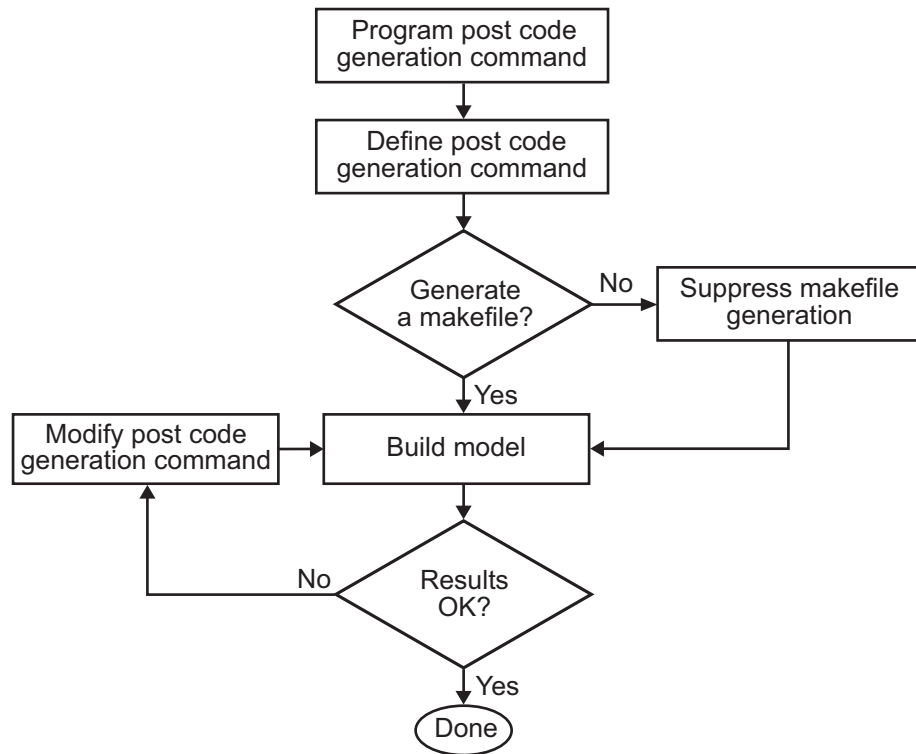

- 1 Program the post code generation command.
- 2 Define the post code generation command.
- 3 Suppress makefile generation, if applicable..
- 4 Build the model.

- 5 Modify the command and rebuild the model until the build results are acceptable.

## **Build Information Object**

At the start of a model build, the Simulink Coder build process logs the following build option and dependency information to a temporary build information object:

- Compiler options
- Preprocessor identifier definitions
- Linker options
- Source files and paths
- Include files and paths
- Precompiled external libraries

You can retrieve information from and add information to this object by using an extensive set of functions. For a list of available functions and detailed function descriptions, see “Build Process”. “Program a Post Code Generation Command” on page 22-14 explains how to use the functions to control post code generation build processing.

## **Program a Post Code Generation Command**

For certain applications, you might want to control aspects of the build process after the code generation. For example, you might do this if you develop your own target, or you want to apply an analysis tool to the generated code before continuing with the build process. You can apply this level of control to the build process by programming and then defining a post code generation command.

A post code generation command is a MATLAB language file that typically calls functions that get data from or add data to the model’s build information object. You can program the command as a script or function.

If You Program the Command as a...	Then the...
Script	Script can gain access to the model name and the build information directly
Function	Function can pass the model name and the build information as arguments

If your post code generation command calls user-defined functions, make sure the functions are on the MATLAB path. If the Simulink Coder build process cannot find a function you use in your command, the build process errors out.

You can then call any combination of build information functions, as listed in “Build Process”, to customize the model’s post code generation build processing.

The following example shows a fragment of a post code generation command that gets the filenames and paths of the source and include files generated for a model for analysis.

```
function analyzegeneratecode(buildInfo)
% Get the names and paths of all source and include files
% generated for the model and then analyze them.

% buildInfo - build information for my model.

% Define cell array to hold data.
MyBuildInfo={};

% Get source file information.
MyBuildInfo.srcfiles=getSourceFiles(buildInfo, true, true);
MyBuildInfo.srcpaths=getSourcePaths(buildInfo, true);

% Get include (header) file information.
MyBuildInfo.incfiles=getIncludeFiles(buildInfo, true, true);
MyBuildInfo.incpaths=getIncludePaths(buildInfo, true);

% Analyze generated code.
.
.
```

## Define a Post Code Generation Command

After you program a post code generation command, you need to inform the Simulink Coder build process that the command exists and to add it to the model's build processing. You do this by defining the command with the `PostCodeGenCommand` model configuration parameter. When you define a post code generation command, the Simulink Coder build process evaluates the command after generating and writing the model's code to disk and before generating a makefile.

As the following syntax lines show, the arguments that you specify when setting the configuration parameter varies depending on whether you program the command as a script, function, or set of functions.

---

**Note** When defining the command as a function, you can specify an arbitrary number of input arguments. To pass the model's name and build information to the function, specify identifiers `modelName` and `buildInfo` as arguments.

---

### Script

```
set_param(model, 'PostCodeGenCommand',...  
  'pcgScriptName');
```

### Function

```
set_param(model, 'PostCodeGenCommand',...  
  'pcgFunctionName(modelName)');
```

### Multiple Functions

```
pcgFunctions=...  
  'pcgFunction1Name(modelName);...  
  pcgFunction2Name(buildInfo)';  
set_param(model, 'PostCodeGenCommand',...  
  pcgFunctions);
```

The following call to `set_param` defines `PostCodGenCommand` to evaluate the function `analyzeencode`.



```
set_param(model, 'PostCodeGenCommand', ...  
'analyzeencode(buildInfo)');
```

## Suppress Makefile Generation

The Simulink Coder product provides the ability to suppress makefile generation during the build process. For example, you might do this to integrate tools into the build process that are not driven by makefiles.

To instruct the Simulink Coder build process to not generate a makefile, do one of the following:

- Clear the **Generate makefile** option on the **Code Generation** pane of the Configuration Parameters dialog box.
- Set the value of the configuration parameter `GenerateMakefile` to `off`.

When you suppress makefile generation,

- You no longer can explicitly specify a make command or template makefile.
- You must specify your own instructions for any post code generation processing, including compilation and linking, in a post code generation command as explained in “Program a Post Code Generation Command” on page 22-14 and “Define a Post Code Generation Command” on page 22-16.

## Configure Generated Code with TLC

### In this section...

“About Configuring Generated Code with TLC” on page 22-18

“Assigning Target Language Compiler Variables” on page 22-18

“Set Target Language Compiler Options” on page 22-20

### About Configuring Generated Code with TLC

You can use the Target Language Compiler (TLC) to fine tune your generated code. TLC supports extended code generation variables and options in addition to parameters available on the **Code Generation** pane on the Configuration Parameters dialog box. There are two ways to set TLC variables and options, as described in this section.

---

**Note** You should not customize TLC files in the folder `matlabroot/rtw/c/tlc` even though the capability exists to do so. Such TLC customizations might not be applied during the code generation process and can lead to unpredictable results.

---

### Assigning Target Language Compiler Variables

The `%assign` statement lets you assign a value to a TLC variable, as in

```
%assign MaxStackSize = 4096
```

This is also known as creating a *parameter name/parameter value pair*.

For a description of the `%assign` statement see “Target Language Compiler Directives”. You should write your `%assign` statements in the **Configure RTW code generation settings** section of the system target file.

The following table lists the code generation variables you can set with the `%assign` statement.

## Target Language Compiler Optional Variables

Variable	Description
MaxStackSize=N	<p>When the <b>Enable local block outputs</b> check box is selected, the total allocation size of local variables that are declared by all block outputs in the model cannot exceed MaxStackSize (in bytes). MaxStackSize can be any positive integer. If the total size of local block output variables exceeds this maximum, the remaining block output variables are allocated in global, rather than local, memory. The default value for MaxStackSize is <code>rtInf</code>, that is, unlimited stack size.</p> <p><b>Note:</b> Local variables in the generated code from sources other than local block outputs, such as from a Stateflow diagram or MATLAB Function block, and stack usage from sources such as function calls and context switching are not included in the MaxStackSize calculation. For overall executable stack usage metrics, do a target-specific measurement by using run-time (empirical) analysis or static (code path) analysis with object code.</p>
MaxStackVariableSize=N	<p>When the <b>Enable local block outputs</b> check box is selected, this limits the size of any local block output variable declared in the code to N bytes, where <math>N &gt; 0</math>. A variable whose size exceeds MaxStackVariableSize is allocated in global, rather than local, memory. The default is 4096.</p>
WarnNonSaturatedBlocks= <i>value</i>	<p>Flag to control display of overflow warnings for blocks that have saturation capability, but have it turned off (unchecked) in their dialog. These are the options:</p> <ul style="list-style-type: none"> <li>• 0 — No warning is displayed.</li> <li>• 1 — Displays one warning for the model during code generation</li> <li>• 2 — Displays one warning that contains a list of all offending blocks</li> </ul>

### **Set Target Language Compiler Options**

You can enter TLC options in the **TLC options** edit field on the **Code Generation** pane of the Configuration Parameters dialog box. For information about these options, see “Specify TLC Options” on page 15-12 and “Configure TLC”.

## Customize Build Process with STF\_make\_rtw\_hook File

### In this section...

“About the STF\_make\_rtw\_hook File” on page 22-21

“Conventions for Using the STF\_make\_rtw\_hook File” on page 22-21

“STF\_make\_rtw\_hook.m Function Prototype and Arguments” on page 22-22

“Applications for STF\_make\_rtw\_hook.m” on page 22-25

“Control Code Regeneration Using STF\_make\_rtw\_hook.m” on page 22-26

“Use STF\_make\_rtw\_hook.m for Your Build Procedure” on page 22-27

### About the STF\_make\_rtw\_hook File

The build process lets you supply optional hook files that are executed at specified points in the code-generation and make process. You can use hook files to add target-specific actions to the build process.

This section describes an important MATLAB hook, generically referred to as *STF\_make\_rtw\_hook.m*, where *STF* is the name of a system target file, such as *ert* or *mytarget*. This hook file implements a function, *STF\_make\_rtw\_hook*, that dispatches to a specific action, depending on the *hookMethod* argument passed in.

The build process automatically calls *STF\_make\_rtw\_hook*, passing in the *hookMethod* argument (as well as other arguments described below). You need to implement only those hook methods that your build process requires.

### Conventions for Using the STF\_make\_rtw\_hook File

For the build process to call the *STF\_make\_rtw\_hook*, check that the following conditions are met:

- The *STF\_make\_rtw\_hook.m* file is on the MATLAB path.
- The filename is the name of your system target file (STF), appended to the string *\_make\_rtw\_hook.m*. For example, if you were generating code with a custom system target file *mytarget.tlc*, you would name your *STF\_make\_rtw\_hook.m* file to *mytarget\_make\_rtw\_hook.m*. Likewise, the

hook function implemented within the file should follow the same naming convention.

- The hook function implemented in the file follows the function prototype described in the next section.

## **STF\_make\_rtw\_hook.m Function Prototype and Arguments**

The function prototype for *STF\_make\_rtw\_hook* is

```
function STF_make_rtw_hook(hookMethod, modelName, rtwRoot, templateMakefile,  
buildOpts, buildArgs)
```

The arguments are defined as:

- **hookMethod**: String specifying the stage of build process from which the *STF\_make\_rtw\_hook* function is called. The flowchart below summarizes the build process, highlighting the hook points. Valid values for **hookMethod** are 'entry', 'before\_tlc', 'after\_tlc', 'before\_make', 'after\_make', 'exit', and 'error'. The *STF\_make\_rtw\_hook* function dispatches to the relevant code with a switch statement.

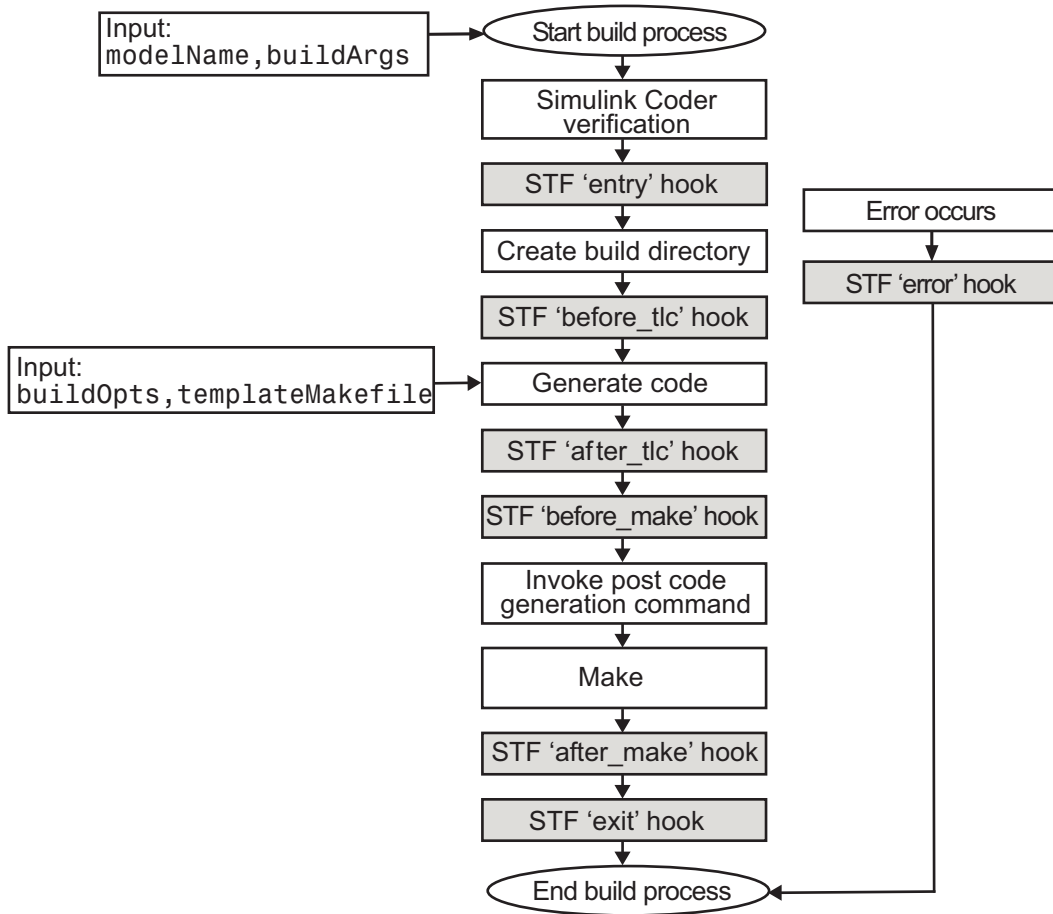

- `modelName`: String specifying the name of the model. Valid at all stages of the build process.
- `rtwRoot`: Reserved.
- `templateMakefile`: Name of template makefile.

- **buildOpts**: A MATLAB structure containing the fields described in the list below. Valid for the 'before\_make', 'after\_make', and 'exit' stages only. The buildOpts fields include:
  - **modules**: Character array specifying a list of additional files that need to be compiled.
  - **codeFormat**: Character array containing code format specified for the target. (ERT-based targets must use the 'Embedded-C' code format.)
  - **noninlinedSFcns**: Cell array specifying list of noninlined S-functions in the model.
  - **compilerEnvVal**: String specifying compiler environment variable value (for example, C:\Applications\Microsoft Visual).
- **buildArgs**: Character array containing the argument to `make_rtw`. When you invoke the build process, **buildArgs** is copied from the argument string (if any) following "make\_rtw" in the **Make command** field of the **Code Generation** pane of the Configuration Parameters dialog box.

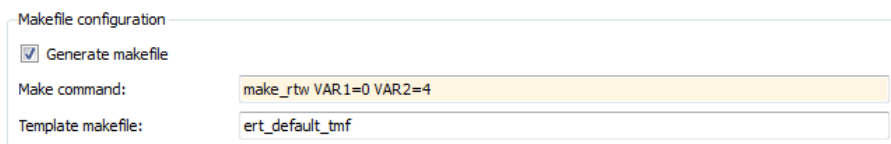

Makefile configuration

Generate makefile

Make command: `make_rtw VAR1=0 VAR2=4`

Template makefile: `ert_default_tmf`

The make arguments from the **Make command** field in the figure above, for example, generate the following:

```
% make -f untitled.mk VAR1=0 VAR2=4
```



## Applications for STF\_make\_rtw\_hook.m

An enumeration of all possible uses for *STF\_make\_rtw\_hook.m* is beyond the scope of this document. However, this section provides some suggestions of how you might apply the available hooks.

In general, you can use the 'entry' hook to initialize the build process before any code is generated, for example to change or validate settings. One application for the 'entry' hook is to rerun the auto-configuration script that initially ran at target selection time to compare model parameters before and after the script executes for validation purposes.

The other hook points, 'before\_tlc', 'after\_tlc', 'before\_make', 'after\_make', 'exit', and 'error' are useful for interfacing with external tool chains, source control tools, and other environment tools.

For example, you could use the *STF\_make\_rtw\_hook.m* file at any stage after 'entry' to obtain the path to the build folder. At the 'exit' stage, you could then locate generated code files within the build folder and check them into your version control system. You might use 'error' to clean up static or global data used by the hook function when an error occurs during code generation or the build process.

Note that the build process temporarily changes the MATLAB working folder to the build folder for stages 'before\_make', 'after\_make', 'exit', and 'error'. Your *STF\_make\_rtw\_hook.m* file should not make incorrect assumptions about the location of the build folder. You can obtain the path to the build folder anytime after the 'entry' stage. In the following code example, the build folder path is returned as a string to the variable `buildDirPath`.

```
makertwObj = get_param(gcs, 'MakeRTWSettingsObject');  
buildDirPath = getfield(makertwObj, 'BuildDirectory');
```

## Control Code Regeneration Using `STF_make_rtw_hook.m`

When you rebuild a model, by default, the build process performs checks to determine whether changes to the model or relevant settings require regeneration of the top model code. (For details on the criteria, see “Control Regeneration of Top Model Code” on page 15-27.) If the checks determine that top model code generation is required, the build process fully regenerates and compiles the model code. If the checks indicate that the top model generated code is current with respect to the model, and no model settings require full regeneration, the build process omits regeneration of the top model code.

Regardless of whether the top model code is regenerated, the build process subsequently calls all build process hooks, including `STF_make_rtw_hook` functions and the post code generation command. The following mechanisms allow you to perform actions related to code regeneration in the `STF_make_rtw_hook` functions:

- To force code regeneration, use the following function call from the 'entry' hook:

```
rtw.targetNeedsCodeGen('set', true);
```

- In all hooks from 'before\_tlc' through 'exit', the `buildOpts` structure passed to the hook has a Boolean field `codeWasUpToDate`, which is set to `true` if model code was up to date and code was not regenerated, or `false` if code was not up to date and code was regenerated. You can customize hook actions based on the value of this field. For example:

```
...
case `before_tlc`
    if buildOpts.codeWasUpToDate
        %Perform hook actions for up to date model
    else
        %Perform hook actions for full code generation
    end
...

```

## Use STF\_make\_rtw\_hook.m for Your Build Procedure

To create a custom *STF\_make\_rtw\_hook* hook file for your build procedure, copy and edit the example *ert\_make\_rtw\_hook.m* file (located in the *matlabroot/toolbox/rtw/targets/ecoder* folder) as follows:

- 1** Copy *ert\_make\_rtw\_hook.m* to a folder in the MATLAB path, and rename it in accordance with the naming conventions described in “Conventions for Using the STF\_make\_rtw\_hook File” on page 22-21. For example, to use it with the GRT target *grt.tlc*, rename it to *grt\_make\_rtw\_hook.m*.
- 2** Rename the *ert\_make\_rtw\_hook* function within the file to match the filename.
- 3** Implement the hooks that you require by adding code to case statements within the `switch hookMethod` statement.

## Customize Build Process with `sl_customization.m`

### In this section...

“About `sl_customization.m`” on page 22-28

“Register Build Process Hook Functions Using `sl_customization.m`” on page 22-30

“Variables Available for `sl_customization.m` Hook Functions” on page 22-31

“Example Build Process Customization Using `sl_customization.m`” on page 22-31

### About `sl_customization.m`

The Simulink customization file `sl_customization.m` is a mechanism that allows you to use MATLAB to customize the standard Simulink user interface. The Simulink software reads the `sl_customization.m` file, if present on the MATLAB path, when it starts and the customizations specified in the file are applied to the Simulink session. For more information on the `sl_customization.m` customization file, see “Registering Customizations”.

The `sl_customization.m` file can be used to register installation-specific hook functions to be invoked during the Simulink Coder build process. The hook functions that you register through `sl_customization.m` complement System Target File (STF) hooks (described in “Customize Build Process with `STF_make_rtw_hook` File” on page 22-21) and post-code generation commands (described in “Customize Post-Code-Generation Build Processing” on page 22-13).

The following figure shows the relationship between installation-level hooks and the other available mechanisms for customizing the build process.

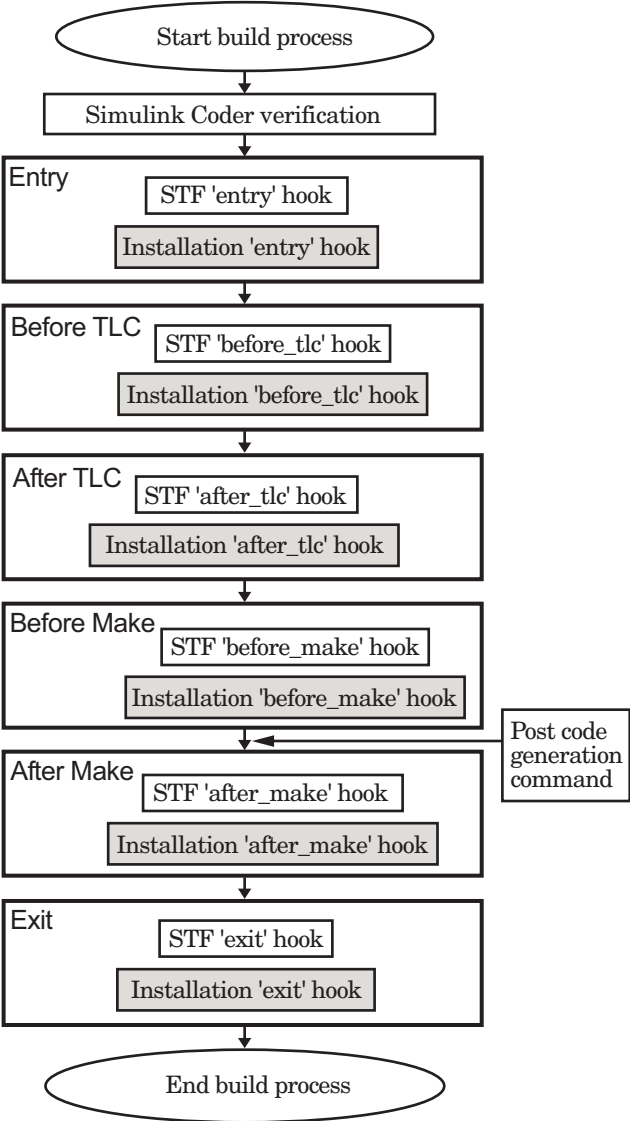

## Register Build Process Hook Functions Using `sl_customization.m`

To register installation-level hook functions that will be invoked during the Simulink Coder build process, you create a MATLAB function called `sl_customization.m` and include it on the MATLAB path of the Simulink installation that you want to customize. The `sl_customization` function accepts one argument: a handle to a customization manager object. For example,

```
function sl_customization(cm)
```

As a starting point for your customizations, the `sl_customization` function must first get the default (factory) customizations, using the following assignment statement:

```
hObj = cm.RTWBuildCustomizer;
```

You then invoke methods to register your customizations. The customization manager object includes the following method for registering Simulink Coder build process hook customizations:

- `addUserHook(hObj, hookType, hook)`

Registers the MATLAB hook script or function specified by `hook` for the build process stage represented by `hookType`. The valid values for `hookType` are 'entry', 'before\_tlc', 'after\_tlc', 'before\_make', 'after\_make', and 'exit'.

Your instance of the `sl_customization` function should use this method to register installation-specific hook functions.

The Simulink software reads the `sl_customization.m` file when it starts. If you subsequently change the file, you must restart the Simulink session or enter the following command at the MATLAB command line to effect the changes:

```
sl_refresh_customizations
```

## Variables Available for sl\_customization.m Hook Functions

The following variables are available for sl\_customization.m hook functions to use:

- `modelName` — The name of the Simulink model (valid for all stages)
- `dependencyObject` — An object containing the dependencies of the generated code (valid only for the 'after\_make' stage)

A hook script can directly access the valid variables. A hook function can pass the valid variables as arguments to the function. For example:

```
hObj.addUserHook('after_make', 'afterMakeFunction(modelName,dependencyObject)');
```

## Example Build Process Customization Using sl\_customization.m

The sl\_customization.m file shown in Example 1: sl\_customization.m for Simulink® Coder™ Build Process Customizations on page 22-31 uses the addUserHook method to specify installation-specific build process hooks to be invoked at the 'entry' and 'after\_tlc' stages of the Simulink Coder build. For the hook function source code, see Example 2: CustomRTWEntryHook.m on page 22-32 and Example 3: CustomRTWPostProcessHook.m on page 22-32.

### Example 1: sl\_customization.m for Simulink Coder Build Process Customizations

```
function sl_customization(cm)
% Register user customizations

% Get default (factory) customizations
hObj = cm.RTWBuildCustomizer;

% Register build process hooks
hObj.addUserHook('entry', 'CustomRTWEntryHook(modelName)');
hObj.addUserHook('after_tlc', 'CustomRTWPostProcessHook(modelName)');

end
```

### Example 2: CustomRTWEntryHook.m

```
function [str, status] = CustomRTWEntryHook(modelName)
str =sprintf('Custom entry hook for model '%s.',modelName);
disp(str)
status =1;
```

### Example 3: CustomRTWPostProcessHook.m

```
function [str, status] = CustomRTWPostProcessHook(modelName)
str =sprintf('Custom post process hook for model '%s.',modelName);
disp(str)
status =1;
```

If you include the above three files on the MATLAB path of the Simulink installation that you want to customize, the coded hook function messages will appear in the displayed output for Simulink Coder builds. For example, if you open the ERT-based model `rtwdemo_udt`, open the **Code Generation** pane of the Configuration Parameters dialog box, and click the **Build** button to initiate a Simulink Coder build, the following messages are displayed:

```
>> rtwdemo_udt

### Starting build procedure for model: rtwdemo_udt
Custom entry hook for model 'rtwdemo_udt.'
Custom post process hook for model 'rtwdemo_udt.'
### Successful completion of build procedure for model: rtwdemo_udt
>>
```



## Replace the `STF_rtw_info_hook` Mechanism

Prior to MATLAB Release 14, custom targets supplied target-specific information with a hook file (referred to as `STF_rtw_info_hook.m`). The `STF_rtw_info_hook` specified properties such as word sizes for integer data types (for example, `char`, `short`, `int`, and `long`), and C implementation-specific properties of the custom target.

The `STF_rtw_info_hook` mechanism has been replaced by the **Hardware Implementation** pane of the Configuration Parameters dialog box. Using this dialog box, you can specify all properties that were formerly specified in your `STF_rtw_info_hook` file.

For backward compatibility, existing `STF_rtw_info_hook` files are available. However, you should convert your target and models to use of the **Hardware Implementation** pane. See “Target” on page 9-9 .

## Customize Build to Use Shared Utility Code

The shared utility folders (`slprj/target/_sharedutils`) typically store generated utility code that is common to a top model and the models it references. You can also force the build process to use a shared utilities folder for a standalone model. See “Logging” on page 15-105 for details.

If you want your target to support compilation of code generated in the shared utilities folder, you must modify your template makefile (TMF). The shared utilities folder is required to support model reference builds. See “Support Model Referencing” on page 24-101 to learn about additional updates for supporting model reference builds.

The exact syntax of the changes can vary due to differences in the `make` utility and compiler/archive tools used by your target. The examples below are based on the Free Software Foundation’s GNU `make` utility. You can find the following updated TMF examples for GNU and Microsoft Visual C++ `make` utilities in the GRT and ERT target folders:

- GRT: `matlabroot/rtw/c/grt/`
  - `grt_lcc.tmf`
  - `grt_vc.tmf`
  - `grt_unix.tmf`
- ERT: `matlabroot/rtw/c/ert/`
  - `ert_lcc.tmf`
  - `ert_vc.tmf`
  - `ert_unix.tmf`

Use the GRT or ERT examples as a guide to the location, within the TMF, of the changes and additions described below.

---

**Note** The ERT-based TMFs contain extra code to handle generation of ERT S-functions and model reference simulation targets. Your target does not need to handle these cases.

---

## Modify Template Makefiles to Support Shared Utilities

Make the following changes to your TMF to support the shared utilities folder:

- 1 Add the following make variables and tokens to be expanded when the makefile is generated:

```

SHARED_SRC      = |>SHARED_SRC<|
SHARED_SRC_DIR  = |>SHARED_SRC_DIR<|
SHARED_BIN_DIR  = |>SHARED_BIN_DIR<|
SHARED_LIB      = |>SHARED_LIB<|

```

SHARED\_SRC specifies the shared utilities folder location and the source files in it. A typical expansion in a makefile is

```
SHARED_SRC      = ../slprj/ert/_sharedutils/*.c
```

SHARED\_LIB specifies the library file built from the shared source files, as in the following expansion.

```
SHARED_LIB      = ../slprj/ert/_sharedutils/rtwshared.lib
```

SHARED\_SRC\_DIR and SHARED\_BIN\_DIR allow specification of separate folders for shared source files and the library compiled from the source files. In the current release, all TMFs use the same path, as in the following expansions.

```

SHARED_SRC_DIR = ../slprj/ert/_sharedutils
SHARED_BIN_DIR = ../slprj/ert/_sharedutils

```

- 2 Set the SHARED\_INCLUDES variable according to whether shared utilities are in use. Then append it to the overall INCLUDES variable.

```

SHARED_INCLUDES =
ifneq ($(SHARED_SRC_DIR),)
SHARED_INCLUDES = -I$(SHARED_SRC_DIR)
endif

```

```

INCLUDES = -I. $(MATLAB_INCLUDES) $(ADD_INCLUDES) \
           $(USER_INCLUDES) $(SHARED_INCLUDES)

```

- 3** Update the `SHARED_SRC` variable to list all shared files explicitly.

```
SHARED_SRC := $(wildcard $(SHARED_SRC))
```

- 4** Create a `SHARED_OBJS` variable based on `SHARED_SRC`.

```
SHARED_OBJS = $(addsuffix .o, $(basename $(SHARED_SRC)))
```

- 5** Create an `OPTS` (options) variable for compilation of shared utilities.

```
SHARED_OUTPUT_OPTS = -o @$
```

- 6** Provide a rule to compile the shared utility source files.

```
$(SHARED_OBJS) : $(SHARED_BIN_DIR)/%.o : $(SHARED_SRC_DIR)/%.c  
$(CC) -c $(CFLAGS) $(SHARED_OUTPUT_OPTS) $<
```

- 7** Provide a rule to create a library of the shared utilities. The following example is based on The Open Group UNIX platforms.

```
$(SHARED_LIB) : $(SHARED_OBJS)  
@echo "### Creating @$ "  
ar r @$ $(SHARED_OBJS)  
@echo "### Created @$ "
```

- 8** Add `SHARED_LIB` to the rule that creates the final executable.

```
$(PROGRAM) : $(OBJS) $(LIBS) $(SHARED_LIB)  
$(LD) $(LDFLAGS) -o @$ $(LINK_OBJS) $(LIBS) $(SHARED_LIB) \  
$(SYSLIBS)  
@echo "### Created executable: $(MODEL) "
```

- 9** Remove any explicit reference to `rt_nonfinite.c` or `rt_nonfinite.cpp` from your `TMF`. For example, change

```
ADD_SRCS = $(RTWLOG) rt_nonfinite.c
```

to

```
ADD_SRCS = $(RTWLOG)
```

# Run-Time Data Interface Extensions

---

- “Customize an ASAP2 File” on page 23-2
- “Create a Transport Layer for External Communication” on page 23-14

## Customize an ASAP2 File

### In this section...

“About ASAP2 File Customization” on page 23-2

“ASAP2 File Structure on the MATLAB Path” on page 23-2

“Customize the Contents of the ASAP2 File” on page 23-3

“ASAP2 Templates” on page 23-4

“Use GROUP and SUBGROUP Hierarchies to Organize Signals and Parameters” on page 23-6

“Customize Computation Method Names” on page 23-12

“Suppress Computation Methods for FIX\_AXIS” on page 23-13

### About ASAP2 File Customization

The Embedded Coder product provides a number of Target Language Compiler (TLC) files to enable you to customize the ASAP2 file generated from a Simulink model.

### ASAP2 File Structure on the MATLAB Path

The ASAP2 related files are organized within the folders identified below:

- TLC files for generating ASAP2 file

The *matlabroot/rtw/c/tlc/mw* folder contains TLC files that generate ASAP2 files, *asamlib.tlc*, *asap2lib.tlc*, *asap2main.tlc*, and *asap2group1lib.tlc*. These files are included by the selected **System target file**. (See “Targets Supporting ASAP2” on page 15-175.)

- ASAP2 target files

The *matlabroot/toolbox/rtw/targets/asap2/asap2* folder contains the ASAP2 system target file and other control files.

- Customizable TLC files

The `matlabroot/toolbox/rtw/targets/asap2/asap2/user` folder contains files that you can modify to customize the content of your ASAP2 files.

- ASAP2 templates

The `matlabroot/toolbox/rtw/targets/asap2/asap2/user/templates` folder contains templates that define each type of CHARACTERISTIC in the ASAP2 file.

## Customize the Contents of the ASAP2 File

The ASAP2 related TLC files enable you to customize the appearance of the ASAP2 file generated from a Simulink model. Most customization is done by modifying or adding to the files contained in the `matlabroot/toolbox/rtw/targets/asap2/asap2/user` folder. This section refers to this folder as the `asap2/user` folder.

The user-customizable files provided are divided into two groups:

- The *static* files define the parts of the ASAP2 file that are related to the environment in which the generated code is used. They describe information specific to the user or project. The static files are not model dependent.
- The *dynamic* files define the parts of the ASAP2 file that are generated based on the structure of the source model.

The procedure for customizing the ASAP2 file is as follows:

- 1** Make a copy of the `asap2/user` folder before making any modifications.
- 2** Remove the old `asap2/user` folder from the MATLAB path, or add the new `asap2/user` folder to the MATLAB path above the old folder. This ensures that the MATLAB session uses the ASAP2 setup file, `asap2setup.tlc` (new for Release 14).

`asap2setup.tlc` specifies the folders and files to include in the TLC path during the ASAP2 file generation process. Modify `asap2setup.tlc` to control the folders and folders included in the TLC path.

- 3** Modify the static parts of the ASAP2 file. These include

- Project and header symbols, which are specified in `asap2setup.tlc`
- Static sections of the file, such as file header and tail, `A2ML`, `MOD_COMMON`, and so on. These are specified in `asap2userlib.tlc`.
- Specify the appearance of the dynamic contents of the ASAP2 file by modifying the existing ASAP2 templates or by defining new ASAP2 templates. Sections of the ASAP2 file affected include
  - `RECORD_LAYOUT`: modify parts of the ASAP2 template files.
  - `CHARACTERISTIC`: modify parts of the ASAP2 template files. For more information on modifying the appearance of `CHARACTERISTIC` records, see “ASAP2 Templates” on page 23-4.
- `MEASUREMENT`: These are specified in `asap2userlib.tlc`.
- `COMPU_METHOD`: These are specified in `asap2userlib.tlc`.

## ASAP2 Templates

The appearance of `CHARACTERISTIC` records in the ASAP2 file is controlled using a different template for each type of `CHARACTERISTIC`. The `asap2/user` folder contains template definition files for scalars, 1-D Lookup Table blocks and 2-D Lookup Table blocks. You can modify these template definition files, or you can create additional templates as required.

The procedure for creating a new ASAP2 template is as follows:

- 1** Create a template definition file. See “Create Template Definition Files” on page 23-4.
- 2** Include the template definition file in the TLC path. The path is specified in the ASAP2 setup file, `asap2setup.tlc`.

### Create Template Definition Files

This section describes the components that make up an ASAP2 template definition file. This description is in the form of code examples from `asap2lookup1d.tlc`, the template definition file for the `Lookup1D` template. This template corresponds to the `Lookup1D` parameter group.



---

**Note** When creating a new template, use the corresponding parameter group name in place of Lookup1D in the code shown.

---

### Template Registration Function

The input argument is the name of the parameter group associated with this template:

```
%<LibASAP2RegisterTemplate("Lookup1D")>
```

### RECORD\_LAYOUT Name Definition Function

Record layout names (aliases) can be arbitrarily specified for each data type. This function is used by the other components of this file.

```
%function ASAP2UserFcnRecordLayoutAlias_Lookup1D(dtId) void
    %switch dtId
        %case tSS_UINT8
            %return "Lookup1D_UBYTE"
        ...
    %endswitch
%endfunction
```

### Function to Write RECORD\_LAYOUT Definitions

This function writes RECORD\_LAYOUT definitions associated with this template. The function is called by the built-in functions involved in the ASAP2 file generation process. The function name must be defined as shown, with the template name after the underscore:

```
%function ASAP2UserFcnWriteRecordLayout_Lookup1D() Output
    /begin RECORD_LAYOUT
    %<ASAP2UserFcnRecordLayoutAlias_Lookup1D(tSS_UINT8)>
        ...
    /end RECORD_LAYOUT
%endfunction
```

### Function to Write the CHARACTERISTIC

This function writes the CHARACTERISTIC associated with this template. The function is called by the built-in functions involved in the ASAP2 file generation process. The function name must be defined as shown, with the template name after the underscore.

The input argument to this function is a pointer to a parameter group record. The example shown is for a Lookup1D parameter group that has two members. The references to the associated x and y data records are obtained from the parameter group record as shown.

This function calls a number of built-in functions to obtain the required information. For example, LibASAP2GetSymbol returns the symbol (name) for the specified data record:

```
%function ASAP2UserFcnWriteCharacteristic_Lookup1D(paramGroup)
Output
  %assign xParam = paramGroup.Member[0].Reference
  %assign yParam = paramGroup.Member[1].Reference
  %assign dtId = LibASAP2GetDataTypeId(xParam)
  /begin CHARACTERISTIC
    /* Name */           %<LibASAP2GetSymbol(xParam)>
    /* Long identifier */ %<LibASAP2GetLongID(xParam)>"
    ...
  /end CHARACTERISTIC
%endfunction
```

### Use GROUP and SUBGROUP Hierarchies to Organize Signals and Parameters

- “Signal and Parameter Grouping Overview” on page 23-7
- “TLC Functions for Defining and Adding Groups” on page 23-7
- “ASAP2 Simple Grouping” on page 23-9
- “ASAP2 Graphical Grouping” on page 23-10

## Signal and Parameter Grouping Overview

The Simulink Coder product provides TLC functions that allow you to organize signals and parameters in the generated ASAP2 file into groups and subgroups, using the GROUP and SUBGROUP keywords in the ASAP2 standard. Grouping can be done using criteria such as the following:

- Graphical location of the signal or parameter in the model
- Functionality (I/O or local)
- Custom criteria

By default, the build process generates ASAP2 parameter and signal descriptions as a flat list. To generate ASAP2 GROUPs and SUBGROUPs, do the following:

- 1 Use the TLC customization functions that define and add groups.
- 2 Generate code for your model. The code generator automatically generates the defined groups into the ASAP2 file, using the GROUP and SUBGROUP keywords.

## TLC Functions for Defining and Adding Groups

- “Create Groups” on page 23-7
- “Populate Groups” on page 23-8
- “Group by Graphical Hierarchy” on page 23-8

**Create Groups.** The software provides the following TLC functions for creating an ASAP2 group and setting its description and annotation. These functions are defined in the file `matlabroot/rtw/c/tlc/mw/asap2group.lib.tlc` and can be called at any point during the ASAP2 customization process.

Function	Description
LibASAP2CreateGroup( <i>groupName</i> , <i>groupLongIdentifier</i> )	Creates a group with the specified <i>groupName</i> and returns the created group. If the group already exists, returns the existing group.
LibASAP2SetGroupIsRoot( <i>group</i> )	Sets the specified group as a ROOT.
LibASAP2SetGroupAnnotation( <i>group</i> , <i>annotation</i> )	Sets the annotation for the specified group. If annotation already exists, overwrites it.

**Populate Groups.** The software provides the following TLC functions for adding subgroups, characteristics, and measurements to groups. These functions are defined in the file *matlabroot/rtw/c/tlc/mw/asap2grouplib.tlc* and can be called at any point during the ASAP2 customization process.

Function	Description
LibASAP2AddSubGroupToGroup( <i>group</i> , <i>subGroup</i> )	Adds the specified <i>subGroup</i> as a SUB_GROUP of the specified group.
LibASAP2AddCharacteristicToGroup( <i>group</i> , <i>characteristicName</i> )	Adds the specified <i>characteristicName</i> as a REF_CHARACTERISTIC of the specified group.
LibASAP2AddMeasurementToGroup( <i>group</i> , <i>measurementName</i> )	Adds the specified <i>measurementName</i> as a REF_MEASUREMENT of the specified group.

**Group by Graphical Hierarchy.** The software provides the following TLC functions for creating groups based on the graphical hierarchy of signals, states, and parameters in the model. These functions are defined in the file *matlabroot/rtw/c/tlc/mw/asap2grouplib.tlc* and can be called at any point during the ASAP2 customization process.

Function	Description
LibASAP2CreateGraphicalGroups()	Creates groups and subgroups. A group is created for each graphical subsystem in the model. The graphical hierarchy is reflected in the SUB_GROUPS.
LibASAP2AddCharacteristicToGraphical Groups( <i>param</i> )	Adds a CHARACTERISTIC to one or more groups reflecting the locations of the specified parameter in the model.
LibASAP2AddMeasurementToGraphical Group( <i>signal</i> )	Adds a MEASUREMENT to a group and its subgroups reflecting the location of the specified signal or state in the model.

### ASAP2 Simple Grouping

Consider the following model, in which subsystem S1 contains 3 signals and uses 2 parameters:

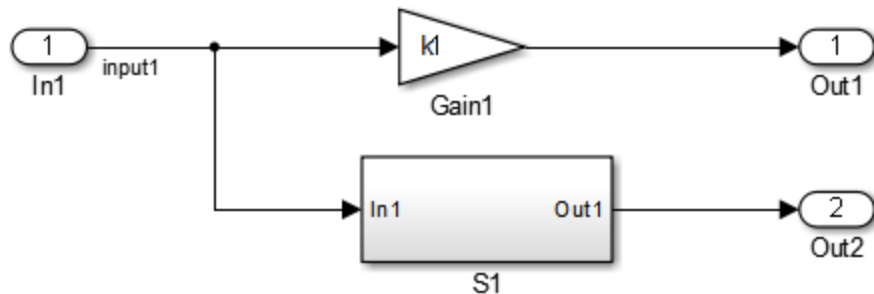

Suppose that you want to do the following:

- Create A ROOT group for the model.
- Organize all signals in the model in a group called Signals, which is a subgroup of ROOT.
- Organize all parameters in the model in a group called Parameters, which is a subgroup of ROOT.

To create this simple grouping, you perform the following steps:

- 1 In your copy of `asap2setup.tlc`, use the TLC functions to create the root group and subgroups. For example:

```

%% Create a root GROUP
%assign ASAP2RootGroup = LibASAP2CreateGroup("%<CompiledModel.Name>", ...
    "%<CompiledModel.Name>")
%<LibASAP2SetGroupIsRoot(ASAP2RootGroup)>
%% -----
%% Create a group for model signals
%assign ASAP2SigGroup = LibASAP2CreateGroup("Signals", ...
    "Measurements in %<CompiledModel.Name>")
%<LibASAP2AddSubGroupToGroup(ASAP2RootGroup, ASAP2SigGroup)>
%% -----
%% Create a group for model parameters
%assign ASAP2ParGroup = LibASAP2CreateGroup("Parameters", ...
    "Characteristics in %<CompiledModel.Name>")
%<LibASAP2AddSubGroupToGroup(ASAP2RootGroup, ASAP2ParGroup)>

```

- 2 In the template function for MEASUREMENTS, `ASAP2UserFcnWriteMeasurementfile`, add each signal to `ASAP2SigGroup`. For example:

```

%<LibASAP2AddMeasurementToGroup(ASAP2SigGroup, LibASAP2GetSymbol(signal))>

```

- 3 In the template function for CHARACTERISTICS, `ASAP2UserFcnWriteCharacteristic_Scalar`, add each parameter to `ASAP2ParGroup`. For example:

```

%<LibASAP2AddCharacteristicToGroup(ASAP2ParGroup, LibASAP2GetSymbol(param))>

```

In the generated ASAP2 file, parameters and signals are separated into groups called Parameters and Signals, under the model root.

## ASAP2 Graphical Grouping

Consider the following model, in which subsystem S1 contains 3 signals and uses 2 parameters, and also contains another subsystem S2:

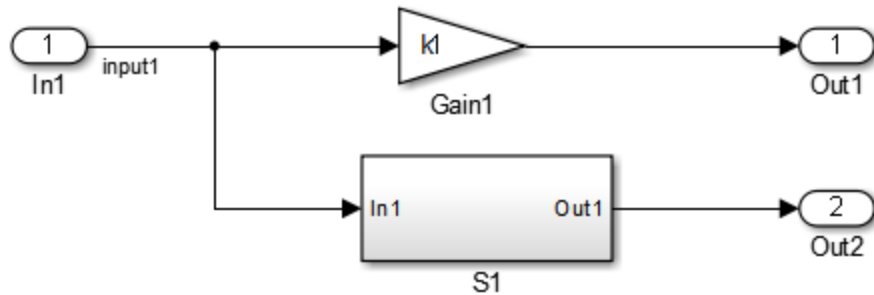

Suppose that you want to do the following:

- Create a ROOT group for the model and create a subgroup for each graphical subsystem in the model.
- Add each signal and state to the group for the subsystem that refers to it.
- Add each parameter to the groups for the subsystems that refer to it. (A parameter can be referred to in multiple subsystems and added to multiple groups.)

To create this graphical grouping, you perform the following steps:

- 1** In your copy of `asap2setup.tlc`, use the TLC functions to create the groups according to the graphical hierarchy. For example:

```
%<LibASAP2CreateGraphicalGroups()
```

- 2** In the template function for MEASUREMENTS, `ASAP2UserFcnWriteMeasurementfile`, add each signal to its graphical group. For example:

```
%<LibASAP2AddMeasurementToGraphicalGroup(signal)>
```

- 3** In the template function for CHARACTERISTICS, `ASAP2UserFcnWriteCharacteristic_Scalar`, add each parameter to its graphical groups. For example:

```
%<LibASAP2AddCharacteristicToGraphicalGroups(param)>
```

In the generated ASAP2 file, the group ordering reflects the graphical hierarchy of the model, **root > S1 > S2**.

## Customize Computation Method Names

In generated ASAP2 files, computation methods translate the electronic control unit (ECU) internal representation of measurement and calibration quantities into a physical model oriented representation. Simulink Coder software provides the ability to customize the names of computation methods. You can provide names that are more intuitive, enhancing ASAP2 file readability, or names that meet organizational requirements.

To customize computation method names, use the MATLAB function `getCompuMethodName`, which is defined in `matlabroot/toolbox/rtw/targets/asap2/asap2/user/getCompuMethodName.m`.

The `getCompuMethodName` function constructs a computation method name. The function prototype is

```
cmName = getCompuMethodName(dataTypeName, cmUnits)
```

where *dataTypeName* is the name of the data type associated with the computation method, *cmUnits* is the units as specified in the `DocUnits` property of a `Simulink.Parameter` or `Simulink.Signal` object (for example, `rpm` or `m/s`), and *cmName* returns the constructed computation method name.

The default constructed name returned by the function has the format

```
<localPrefix><datatype>_<cmUnits>
```

where

- `<local_Prefix>` is a local prefix, `CM_`, defined in `matlabroot/toolbox/rtw/targets/asap2/asap2/user/getCompuMethodName.m`.
- `<datatype>` and `<cmUnits>` are the arguments you specified to the `getCompuMethodName` function.

Additionally, in the generated ASAP2 file, the constructed name is prefixed with `<ASAP2CompuMethodName_Prefix>`, a model prefix defined in `matlabroot/toolbox/rtw/targets/asap2/asap2/user/asap2setup.tlc`.



For example, if you call the `getCompuMethodName` function with the `dataTypeName` argument 'int16' and the `cmUnits` argument 'm/s', and generate an ASAP2 file for a model named `myModel1`, the computation method name would appear in the generated file as follows:

```
/begin COMPU_METHOD
  /* Name of CompuMethod */ myModel1_CM_int16_m_s
  /* Units */ "m/s"
  ...
/end COMPU_METHOD
```

## Suppress Computation Methods for FIX\_AXIS

Versions 1.51 and later of the ASAP2 specification state that for certain cases of lookup table axis descriptions (integer data type and no doc units), a computation method is not required and the Conversion Method parameter must be set to the value `NO_COMPU_METHOD`. You can control whether or not computation methods are suppressed when not required using the Target Language Compiler (TLC) option `ASAP2GenNoCompuMethod`. This TLC option is disabled by default. If you enable the option, ASAP2 file generation does not generate computation methods for lookup table axis descriptions when not required, and instead generates the value `NO_COMPU_METHOD`. For example:

```
/begin CHARACTERISTIC
/* Name          */
lu1d_fix_axisTable_data
...
/begin AXIS_DESCR
  ...
  /* Conversion Method */
NO_COMPU_METHOD
  ...
/end CHARACTERISTIC
```

The `ASAP2GenNoCompuMethod` option is defined in `matlabroot/toolbox/rtw/targets/asap2/asap2/user/asap2setup.tlc`.

## Create a Transport Layer for External Communication

### In this section...

“About Creating a Transport Layer for External Communication” on page 23-14

“Design of External Mode” on page 23-14

“External Mode Communications Overview” on page 23-17

“External Mode Source Files” on page 23-19

“Implement a Custom Transport Layer” on page 23-23

### About Creating a Transport Layer for External Communication

This section helps you to connect your custom target by using External mode using your own low-level communications layer. The topics include:

- An overview of the design and operation of External mode
- A description of External mode source files
- Guidelines for modifying the External mode source files and building an executable to handle the tasks of the default `ext_comm` MEX-file

This section assumes that you are familiar with the execution of Simulink Coder programs, and with the basic operation of External mode.

### Design of External Mode

External mode communication between the Simulink engine and a target system is based on a client/server architecture. The client (the Simulink engine) transmits messages requesting the server (target) to accept parameter changes or to upload signal data. The server responds by executing the request.

A low-level *transport layer* handles physical transmission of messages. Both the Simulink engine and the model code are independent of this layer. Both the transport layer and code directly interfacing to the transport layer are

isolated in separate modules that format, transmit, and receive messages and data packets.

This design makes it possible for different targets to use different transport layers. The GRT, GRT malloc, ERT, and RSim targets support host/target communication by using TCP/IP and RS-232 (serial) communication. The RTWin target supports shared memory communication. The Wind River Systems Tornado target supports TCP/IP only.

The Simulink Coder product provides full source code for both the client and server-side External mode modules, as used by the GRT, GRT malloc, ERT, Rapid Simulation, and Tornado targets, and the Real-Time Windows Target and xPC Target products. The main client-side module is `ext_comm.c`. The main server-side module is `ext_svr.c`.

These two modules call the specified transport layer through the following source files.

### Built-In Transport Layer Implementations

Protocol	Client or Server?	Source Files
TCP/IP	Client (host)	<ul style="list-style-type: none"> <li>• <code>matlabroot/rtw/ext_mode/common/rtiostream_interface.c</code></li> <li>• <code>matlabroot/rtw/c/src/rtiostream/rtiostreamtcpip/-rtiostream_tcpip.c</code></li> </ul>
	Server (target)	<ul style="list-style-type: none"> <li>• <code>matlabroot/rtw/c/src/ext_mode/common/rtiostream_interface.c</code></li> <li>• <code>matlabroot/rtw/c/src/rtiostream/rtiostreamtcpip/-rtiostream_tcpip.c</code></li> </ul>
Serial	Client (host)	<ul style="list-style-type: none"> <li>• <code>matlabroot/rtw/ext_mode/serial/ext_serial_transport.c</code></li> <li>• <code>matlabroot/rtw/c/src/rtiostream/rtiostreamserial/rtiostream_serial.c</code></li> </ul>
	Server (target)	<ul style="list-style-type: none"> <li>• <code>matlabroot/rtw/c/src/ext_mode/serial/ext_svr_serial_transport.c</code></li> <li>• <code>matlabroot/rtw/c/src/rtiostream/rtiostreamserial/rtiostream_serial.c</code></li> </ul>

For serial communication, the modules `ext_serial_transport.c` and `rtiostream_serial.c` implement the client-side transport functions and the modules `ext_svr_serial_transport.c` and

`rtiostream_serial.c` implement the corresponding server-side functions. For TCP/IP communication, the modules `rtiostream_interface.c` and `rtiostream_tcpip.c` implement both client-side and server-side functions. You can edit copies of these files (but do not modify the originals). You can support External mode using your own low-level communications layer by creating similar files using the following templates:

- Client (host) side:  
`matlabroot/rtw/c/src/rtiostream/rtiostreamtcpip/rtiostream_tcpip.c`  
(TCP/IP) or  
`matlabroot/rtw/c/src/rtiostream/rtiostreamserial/rtiostream_serial.c`  
(serial)
- Server (target) side:  
`matlabroot/rtw/c/src/rtiostream/rtiostreamtcpip/rtiostream_tcpip.c`  
(TCP/IP) or  
`matlabroot/rtw/c/src/rtiostream/rtiostreamserial/rtiostream_serial.c`  
(serial)

The file `rtiostream_interface.c` is an interface between the External mode protocol and an `rtiostream` communications channel. For more details on implementing an `rtiostream` communications channel, see “Communications `rtiostream` API” in the Embedded Coder documentation. Implement your `rtiostream` communications channel by using the documented interface to avoid having to make changes to the file `rtiostream_interface.c` or any other External mode related files.

---

**Note** Do not modify working source files. Use the templates provided in the `/custom` or `/rtiostream` folder as starting points, guided by the comments within them.

---

You need only provide code that implements low-level communications. You need not be concerned with issues such as data conversions between host and target, or with the formatting of messages. The Simulink Coder software handles these functions.

On the client (Simulink engine) side, communications are handled by `ext_comm` (for TCP/IP) and `ext_serial_win32_comm` (for serial) MEX-files.

On the server (target) side, External mode modules are linked into the target executable. This takes place automatically if the **External mode** code generation option is selected at code generation time, based on the **External mode transport** option selected in the target code generation options dialog box. These modules, called from the main program and the model execution engine, are independent of the generated model code.

The general procedure for implementing your own client-side low-level transport protocol is as follows:

- 1 Edit the template `rtiostream_tcpip.c` to replace low-level communication calls with your own communication calls.
- 2 Generate a MEX-file executable for your custom transport.
- 3 Register your new transport layer with the Simulink software, so that the transport can be selected for a model using the **Interface** pane of the Configuration Parameters dialog box.

For more details, see “Create a Custom Client (Host) Transport Protocol” on page 23-24.

The general procedure for implementing your own server-side low-level transport protocol is as follows:

- 1 Edit the template `rtiostream_tcpip.c` to replace low-level communication calls with your own communication calls. Typically this involves writing or integrating device drivers for your target hardware.
- 2 Modify template makefiles to support the new transport.

For more details, see “Create a Custom Server (Target) Transport Protocol” on page 23-28.

## External Mode Communications Overview

This section gives a high-level overview of how a Simulink Coder generated program communicates with Simulink External mode. This description is based on the TCP/IP version of External mode that ships with the Simulink Coder product.

For communication to take place,

- The server (target) program must have been built with the conditional `EXT_MODE` defined. `EXT_MODE` is defined in the `model.mk` file if the **External mode** code generation option was selected at code generation time.
- Both the server program and the Simulink software must be executing. This does not mean that the model code in the server system must be executing. The server can be waiting for the Simulink engine to issue a command to start model execution.

The client and server communicate by using bidirectional sockets carrying packets. Packets consist either of *messages* (commands, parameter downloads, and responses) or *data* (signal uploads).

If the target program was invoked with the `-w` command-line option, the program enters a wait state until it receives a message from the host. Otherwise, the program begins execution of the model. While the target program is in a wait state, the Simulink engine can download parameters to the target and configure data uploading.

When the user chooses the **Connect to Target** option from the **Simulation** menu, the host initiates a handshake by sending an `EXT_CONNECT` message. The server responds with information about itself. This information includes

- Checksums. The host uses model checksums to determine that the target code is an exact representation of the current Simulink model.
- Data format information. The host uses this information when formatting data to be downloaded, or interpreting data that has been uploaded.

At this point, host and server are connected. The server is either executing the model or in the wait state. (In the latter case, the user can begin model execution by selecting **Start Real-Time Code** from the **Simulation** menu.)

During model execution, the message server runs as a background task. This task receives and processes messages such as parameter downloads.

Data uploading comprises both foreground execution and background servicing of the signal packets. As the target computes model outputs, it also copies signal values into data upload buffers. This occurs as part of the task

associated with each task identifier (`tid`). Therefore, data collection occurs in the foreground. Transmission of the collected data, however, occurs as a background task. The background task sends the data in the collection buffers to the Simulink engine by using data packets.

The host initiates most exchanges as messages. The target usually sends a response confirming that it has received and processed the message. Examples of messages and commands are

- Connection message / connection response
- Start target simulation / start response
- Parameter download / parameter download response
- Arm trigger for data uploading / arm trigger response
- Terminate target simulation / target shutdown response

Model execution terminates when the model reaches its final time, when the host sends a terminate command, or when a Stop Simulation block terminates execution. On termination, the server informs the host that model execution has stopped, and shuts down its socket. The host also shuts down its socket, and exits External mode.

## External Mode Source Files

- “Client (Host) MEX-file Interface Source Files” on page 23-19
- “Server (Target) Source Files” on page 23-21
- “Other Files in the Server Folder” on page 23-23

### Client (Host) MEX-file Interface Source Files

The source files for the MEX-file interface component are located in the folder `matlabroot/rtw/ext_mode`, except as noted:

- `common/ext_comm.c`

This file is the core of External mode communication. It acts as a relay station between the target and the Simulink engine. `ext_comm.c` communicates to the Simulink engine by using a shared data structure,

ExternalSim. It communicates to the target by using calls to the transport layer.

Tasks carried out by `ext_comm.c` include establishment of a connection with the target, downloading of parameters, and termination of the connection with the target.

- `common/rtiostream_interface.c`

This file is an interface between the External mode protocol and an `rtiostream` communications channel. For more details on implementing an `rtiostream` communications channel, see “Communications `rtiostream` API” in the Embedded Coder documentation. Implement your `rtiostream` communications channel using the documented interface to avoid having to change the file `rtiostream_interface.c` or any other External mode related files.

- `matlabroot/rtw/c/src/rtiostream/rtiostreamtcpip/rtiostream_tcpip.c`

This file implements required TCP/IP transport layer functions. The version of `rtiostream_tcpip.c` shipped with the Simulink Coder software uses TCP/IP functions including `recv()`, `send()`, and `socket()`.

- `matlabroot/rtw/c/src/rtiostream/rtiostreamtserial/rtiostream_serial.c`

This file implements required serial transport layer functions. The version of `rtiostream_serial.c` shipped with the Simulink Coder software uses serial functions including `ReadFile()`, `WriteFile()`, and `CreateFile()`.

- `serial/ext_serial_transport.c`

This file implements required serial transport layer functions. `ext_serial_transport.c` includes `ext_serial_utils.c`, which is located in `matlabroot/rtw/c/src/ext_mode/serial` and contains functions common to client and server sides.

- `common/ext_main.c`

This file is a MEX-file wrapper for External mode. `ext_main.c` interfaces to the Simulink engine by using the standard `mexFunction` call. (See the `mexFunction` reference page and “Application Programming Interfaces to MATLAB” for more information.) `ext_main.c` contains a function dispatcher, `esGetAction`, that sends requests from the Simulink engine to `ext_comm.c`.

- `common/ext_convert.c` and `ext_convert.h`



This file contains functions used for converting data from host to target formats (and vice versa). Functions include byte-swapping (big to little-endian), conversion from non-IEEE floats to IEEE doubles, and other conversions. These functions are called both by `ext_comm.c` and directly by the Simulink engine (by using function pointers).

---

**Note** You do not need to customize `ext_convert` to implement a custom transport layer. However, you might want to customize `ext_convert` for the intended target. For example, if the target represents the float data type in Texas Instruments format, `ext_convert` must be modified to perform a Texas Instruments to IEEE conversion.

---

- `common/extsim.h`

This file defines the `ExternalSim` data structure and access macros. This structure is used for communication between the Simulink engine and `ext_comm.c`.

- `common/extutil.h`

This file contains only conditionals for compilation of the `assert` macro.

- `common/ext_transport.h`

This file defines functions that must be implemented by the transport layer.

## Server (Target) Source Files

These files are part of the run-time interface and are linked into the `model.exe` executable. They are located within `matlabroot/rtw/c/src/ext_mode/` except as noted.

- `common/ext_svr.c`

`ext_svr.c` is analogous to `ext_comm.c` on the host, but generally is responsible for more tasks. It acts as a relay station between the host and the generated code. Like `ext_comm.c`, `ext_svr.c` carries out tasks such as establishing and terminating connection with the host. `ext_svr.c` also contains the background task functions that either write downloaded parameters to the target model, or extract data from the target data buffers and send it back to the host.

- `common/rtiostream_interface.c`

This file is an interface between the External mode protocol and an `rtiostream` communications channel. For more details on implementing an `rtiostream` communications channel, see “Communications `rtiostream` API” in the Embedded Coder documentation. Implement your `rtiostream` communications channel by using the documented interface to avoid having to change the file `rtiostream_interface.c` or any other External mode related files.

- `matlabroot/rtw/c/src/rtiostream/rtiostreamtcpip/rtiostream_tcpip.c`

This file implements required TCP/IP transport layer functions. The version of `rtiostream_tcpip.c` shipped with the Simulink Coder software uses TCP/IP functions including `recv()`, `send()`, and `socket()`.

- `matlabroot/rtw/c/src/rtiostream/rtiostreamtserial/rtiostream_serial.c`

This file implements required serial transport layer functions. The version of `rtiostream_serial.c` shipped with the software uses serial functions including `ReadFile()`, `WriteFile()`, and `CreateFile()`.

- `matlabroot/rtw/c/src/rtiostream.h`

This file defines the `rtIOStream*` functions implemented in `rtiostream_tcpip.c`.

- `serial/ext_svr_serial_transport.c`

This file implements required serial transport layer functions. `ext_svr_serial_transport.c` includes `serial/ext_serial_utils.c`, which contains functions common to client and server sides.

- `common/updown.c`

`updown.c` handles the details of interacting with the target model. During parameter downloads, `updown.c` does the work of installing the new parameters into the model’s parameter vector. For data uploading, `updown.c` contains the functions that extract data from the model’s `blockio` vector and write the data to the upload buffers. `updown.c` provides services both to `ext_svr.c` and to the model code (for example, `grt_main.c`). It contains code that is called by using the background tasks of `ext_svr.c` as well as code that is called as part of the higher priority model execution.

- `matlabroot/rtw/c/src/dt_info.h` (included by generated model build file `model.h`)

These files contain data type transition information that allows access to multi-data type structures across different computer architectures. This information is used in data conversions between host and target formats.

- `common/updown_util.h`

This file contains only conditionals for compilation of the `assert` macro.

- `common/ext_svr_transport.h`

This file defines the `Ext*` functions that must be implemented by the server (target) transport layer.

## Other Files in the Server Folder

- `common/ext_share.h`

Contains message code definitions and other definitions required by both the host and target modules.

- `serial/ext_serial_utils.c`

Contains functions and data structures for communication, MEX link, and generated code required by both the host and target modules of the transport layer for serial protocols.

- The serial transport implementation includes the additional files
  - `serial/ext_serial_pkt.c` and `ext_serial_pkt.h`
  - `serial/ext_serial_port.h`

## Implement a Custom Transport Layer

- “Requirements for Custom Transport Layers” on page 23-24
- “Create a Custom Client (Host) Transport Protocol” on page 23-24
- “Register a Custom Client (Host) Transport Protocol” on page 23-27
- “Create a Custom Server (Target) Transport Protocol” on page 23-28

## Requirements for Custom Transport Layers

- By default, `ext_svr.c` and `updown.c` use `malloc` to allocate buffers in target memory for messages, data collection, and other purposes, although there is also an option to preallocate static memory. If your target uses another memory allocation scheme, you must modify these modules.
- The target is assumed to support both `int32_T` and `uint32_T` data types.

## Create a Custom Client (Host) Transport Protocol

To implement the client (host) side of your low-level transport protocol,

- 1 Edit the template file  
`matlabroot/rtw/c/src/rtiostream/rtiostreamtcpip/rtiostream_tcpip.c`  
to replace low-level communication calls with your own communication calls.
  - a Copy and rename the file to `rtiostream_name.c` (replacing *name* with a name meaningful to you).
  - b Replace the functions `rtIOStreamOpen`, `rtIOStreamClose`, `rtIOStreamSend`, and `rtIOStreamRecv` with functions (of the same name) that call your low-level communication primitives. These functions are called from other External mode modules via `rtiostream_interface.c`. For more information, see “Communications rtiostream API” in the Embedded Coder documentation.
  - c Build your `rtiostream` implementation into a shared library that exports the `rtIOStreamOpen`, `rtIOStreamClose`, `rtIOStreamRecv` and `rtIOStreamSend` functions.
- 2 Build the customized MEX-file executable using the MATLAB `mex` function. See the table MATLAB® Commands to Rebuild `ext_comm` and `ext_serial_win32` MEX-Files on page 23-25 for examples of `mex` invocations.

Do not replace the existing `ext_comm` MEX-file if you want to preserve its existing function. Instead, use the `-output` option to name the resulting executable (for example, `mex -output ext_myrtiostream_comm ...` builds `ext_myrtiostream_comm.mexext`, on Windows platforms).

- 3 Register your new client transport layer with the Simulink software, so that the transport can be selected for a model using the **Interface** pane

of the Configuration Parameters dialog box. For details, see “Register a Custom Client (Host) Transport Protocol” on page 23-27.

The following table lists the commands for building the standard `ext_comm` module on PC and UNIX platforms, and for building the standard `ext_serial_win32` model on a PC platform.

### MATLAB Commands to Rebuild `ext_comm` and `ext_serial_win32` MEX-Files

Platform	Commands
PC, TCP/IP	<pre>&gt;&gt; cd (matlabroot) &gt;&gt; mex rtw\ext_mode\common\ext_comm.c ...       rtw\ext_mode\common\ext_convert.c ...       rtw\ext_mode\common\rtiostream_interface.c ...       -Irtw\c\src -Irtw\c\src\rtiostream\utils ...       -Irtw\c\src\ext_mode\common ...       -Irtw\ext_mode\common ...       -Irtw\ext_mode\common\include ...       -lmwrtiostreamutils ...       -DEXTMODE_TCPIP_TRANSPORT ...       -DSL_EXT_DLL -output toolbox\rtw\rtw\ext_comm</pre> <hr/> <p><b>Note</b> The <code>rtiostream_interface.c</code> function defines <code>RTIOSTREAM_SHARED_LIB</code> as <code>libmwrtiostreamtcpip</code> and dynamically loads the MathWorks TCP/IP <code>rtiostream</code> shared library. Modify this file if you need to load a different <code>rtiostream</code> shared library.</p> <hr/>
UNIX, TCP/IP	Use the PC commands but change <code>-DSL_EXT_DLL</code> to <code>-DSL_EXT_SO</code> , and replace back slashes with forward slashes.
Mac, TCP/IP	Use the PC commands but change <code>-DSL_EXT_DLL</code> to <code>--DSL_EXT_DYLIB</code> , and replace back slashes with forward slashes.

**MATLAB Commands to Rebuild ext\_comm and ext\_serial\_win32 MEX-Files (Continued)**

Platform	Commands
PC, serial	<pre data-bbox="372 395 1154 777"> &gt;&gt; cd (matlabroot) mex rtw\ext_mode\common\ext_comm.c ... rtw\ext_mode\common\ext_convert.c ... rtw\ext_mode\serial\ext_serial_transport.c ... rtw\ext_mode\serial\ext_serial_pkt.c ... rtw\ext_mode\serial\rtiostream_serial_interface.c ... -Irtw\c\src -Irtw\c\src\rtiostream\utils ... -Irtw\c\src\ext_mode\common ... -Irtw\c\src\ext_mode\serial -Irtw\ext_mode\common ... -Irtw\ext_mode\common\include ... -lmwruntimeutils -DSL_EXT_DLL ... -output toolbox\rtw\rtw\ext_serial_win32_comm </pre> <hr/> <p data-bbox="372 847 1317 972"><b>Note</b> The <code>rtiostream_interface.c</code> function defines <code>RTIOSTREAM_SHARED_LIB</code> as <code>libmwruntimestreamserial</code> and dynamically loads the MathWorks serial <code>rtiostream</code> shared library. Modify this file if you need to load a different <code>rtiostream</code> shared library.</p>
UNIX, serial	Use the PC commands but change <code>-DSL_EXT_DLL</code> to <code>-DSL_EXT_SO</code> , and replace back slashes with forward slashes.
Mac, serial	Use the PC commands but change <code>-DSL_EXT_DLL</code> to <code>--DSL_EXT_DYLIB</code> , and replace back slashes with forward slashes.

---

**Note** `mex` requires a compiler supported by the MATLAB API. See the `mex` reference page and “Application Programming Interfaces to MATLAB” for more information about the `mex` function.

---

## Register a Custom Client (Host) Transport Protocol

To register a custom client transport protocol with the Simulink software, you must add an entry of the following form to an `sl_customization.m` file on the MATLAB path:

```
function sl_customization(cm)
    cm.ExtModeTransports.add('stf.tlc', 'transport', 'mexfile', 'Level1');
% -- end of sl_customization
```

where

- `stf.tlc` is the name of the system target file for which the transport will be registered (for example, `grt.tlc`)
- `transport` is the transport name to display in the **Transport layer** menu on the **Interface** pane of the Configuration Parameters dialog box (for example, `mytcpip`)
- `mexfile` is the name of the transport's associated external interface MEX-file (for example, `ext_mytcpip_comm`)

You can specify multiple targets and/or transports with additional `cm.ExtModeTransports.add` lines, for example:

```
function sl_customization(cm)
    cm.ExtModeTransports.add('grt.tlc', 'mytcpip', 'ext_mytcpip_comm', 'Level1');
    cm.ExtModeTransports.add('ert.tlc', 'mytcpip', 'ext_mytcpip_comm', 'Level1');
% -- end of sl_customization
```

If you place the `sl_customization.m` file containing the transport registration information on the MATLAB path, your custom client transport protocol will be registered with each subsequent Simulink session. The name of the transport will appear in the **Transport layer** menu on the **Interface** pane of the Configuration Parameters dialog box. When you select the transport for your model, the name of the associated external interface MEX-file will appear in the noneditable **MEX-file name** field, as shown in the following figure.

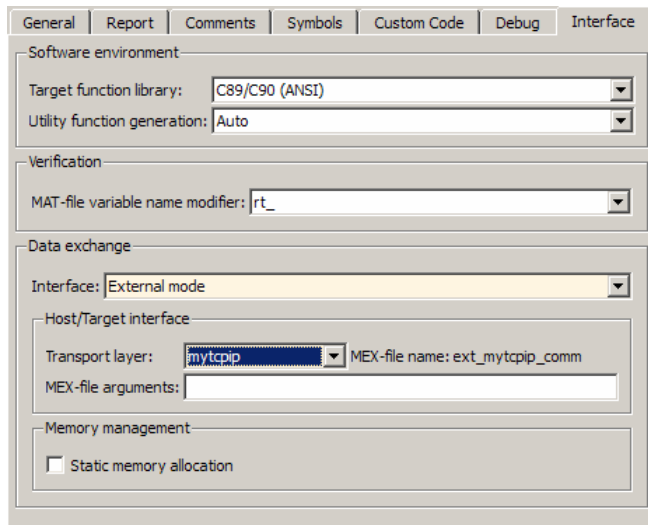

### Create a Custom Server (Target) Transport Protocol

The `rtIOStream*` function prototypes in `matlabroot/rtw/c/src/rtiostream.h` define the calling interface for both the server (target) and client (host) side transport layer functions.

- The TCP/IP implementations are in `matlabroot/rtw/c/src/rtiostream/rtiostreammtcpip/rtiostream_tcpip.c`.
- The serial implementations are in `matlabroot/rtw/c/src/rtiostream/rtiostreamserial/rtiostream_serial.c`.

---

**Note** The `Ext*` function prototypes in `matlabroot/rtw/c/src/ext_mode/common/ext_svr_transport.h` are implemented in `matlabroot/rtw/c/src/ext_mode/common/rtiostream_interface.c` or `matlabroot/rtw/c/src/ext_mode/serial/rtiostream_serial_interface.c`. In most cases you will not need to modify `rtiostream_interface.c` or `rtiostream_serial_interface.c` for your custom TCP/IP or serial transport layer.

---



To implement the server (target) side of your low-level TCP/IP or serial transport protocol,

**1** Edit the template

`matlabroot/rtw/c/src/rtiostream/rtiostreamtcpip/rtiostream_tcpip.c`  
or

`matlabroot/rtw/c/src/rtiostream/rtiostreamserial/rtiostream_serial.c`  
to replace low-level communication calls with your own communication calls.

- a** Copy and rename the file to `rtiostream_name.c` (replacing *name* with a name meaningful to you).
- b** Replace the functions `rtIOStreamOpen`, `rtIOStreamClose`, `rtIOStreamSend`, and `rtIOStreamRecv` with functions (of the same name) that call your low-level communication drivers.

You must implement all the functions defined in `rtiostream.h`, and your implementations must conform to the prototypes defined in that file. Refer to the original `rtiostream_tcpip.c` or `rtiostream_serial.c` for guidance.

- 2** Modify template makefiles to support the new transport. If you are writing your own template makefile, make sure that the `EXT_MODE` code generation option is defined. The generated makefile will then link `rtiostream_name.c`, `rtiostream_interface.c` or `rtiostream_serial_interface.c`, and other server code into your executable.



# Custom Target Development

---

- “About Embedded Target Development” on page 24-2
- “Sample Custom Targets” on page 24-9
- “Target Development Mechanics” on page 24-11
- “Customize System Target Files” on page 24-36
- “Customize Template Makefiles” on page 24-75
- “Support Optional Features” on page 24-100
- “Interface to Development Tools” on page 24-123
- “Device Drivers and Target Preferences” on page 24-135

## About Embedded Target Development

In this section...
“Custom Targets” on page 24-2
“Types of Targets” on page 24-2
“Recommended Features for Embedded Targets” on page 24-5

### Custom Targets

The targets bundled with the Simulink Coder product are suitable for many different applications and development environments. Third-party targets provide additional versatility. However, you might want to implement a custom target for any of the following reasons:

- To enable end users to generate executable production code for a specific CPU or development board, using a specific development environment (compiler/linker/debugger).
- To support I/O devices on the target hardware by incorporating custom device driver blocks into your models.
- To configure the build process for a special compiler (such as a cross-compiler for an embedded microcontroller or DSP board) or development/debugging environment.

The Simulink Coder product provides a point of departure for the creation of custom embedded targets, for the basic purposes above. This manual covers the tasks and techniques you need to implement a custom embedded target.

### Types of Targets

- “Introduction” on page 24-3
- “Rapid Prototyping Targets” on page 24-3
- “Turnkey Production Targets” on page 24-4
- “Verifying Targets With SIL and PIL Testing” on page 24-4
- “HIL Simulation Targets” on page 24-4

## Introduction

The following sections describe several types of targets intended for different use cases. There is a progression of capabilities from the first (baseline or rapid prototyping) to second (turnkey production) target types; you may want to implement an initial rapid prototyping target and a following, more full-featured turnkey version of a target. You might want to use software-in-the-loop (SIL) or processor-in-the-loop (PIL) testing at any stage to verify your embedded target. The target types are not mutually exclusive. An embedded target can support more than one of these use cases, or additional uses not outlined here.

The discussion of target types is followed by “Recommended Features for Embedded Targets” on page 24-5, which contains a suggested list of target features and general guidelines for embedded target development.

## Rapid Prototyping Targets

A *rapid prototyping target* or baseline target offers a starting point for targeting a production processor. A rapid prototyping target integrates Simulink Coder software with one or more popular cross-development environments (compiler/linker/debugger tool chains). A rapid prototyping target provides a starting point from which you can customize the target for application needs.

Target files provided for this type of target should be readable, easy to understand, and fully commented and documented. Specific attention should be paid to the interface to the intended cross-development environment. This interface should be implemented using the preferred approach for that particular development system. For example, some development environments use traditional make utilities, while others are based on project-file builds that can be automated under control of the Simulink Coder software.

When you use a rapid prototyping target, you need to include your own device driver and legacy code and modify linker memory maps to suit your needs. You should be familiar with the targeted development system.

### Turnkey Production Targets

A *turnkey production target* also targets a production processor, but includes the capability to create target executables that interact immediately with the external world. In general, ease of use is more important than simplicity or readability of the target files, because it is assumed that you do not want or need to modify these files.

Desirable features for a turnkey production target include

- Significant I/O driver support provided out of the box
- Easy downloading of generated standalone executables with third-party debuggers
- User-controlled placement of an executable in FLASH or RAM memory
- Support for target visibility and tuning

### Verifying Targets With SIL and PIL Testing

You can use software-in-the-loop (SIL) or processor-in-the-loop (PIL) to verify your generated code and validate the target compiler/processor environment.

You can use SIL and PIL simulation mode to verify automatically generated code by comparing the results with a normal mode simulation. With SIL, you can easily verify the behavior of production-intent source code on your host computer; however, it is generally not possible to verify exactly the same code that will subsequently be compiled for your target hardware because the code must be compiled for your host platform (i.e. a different compiler and different processor architecture than the target). With PIL simulation, you can verify exactly the same code that you intend to deploy in production, and you can run the code either on real target hardware or on an instruction set simulator.

For examples describing how to run processor-in-the-loop testing to verify a custom target, see “Sample Custom Targets” on page 24-9.

For more information on SIL and PIL, see “About SIL and PIL Simulations”.

### HIL Simulation Targets

A specialized use case is the generation of executables intended for use in *Hardware-In-the-Loop* (HIL) simulations. In a HIL simulation, parts of a pure

simulation are gradually replaced with hardware components as components are refined and fabricated. HIL simulation offers an efficient design process that eliminates costly iterations of part fabrication.

## Recommended Features for Embedded Targets

- “Basic Target Features” on page 24-5
- “Integration with Target Development Environments” on page 24-6
- “Observing Execution of Target Code” on page 24-6
- “Deployment and Hardware Issues” on page 24-7

## Basic Target Features

- You can base targets on the Simulink Coder generic real-time (GRT) target or the Embedded Real-Time (ERT) target that is included in the Embedded Coder product.

If your target is based on the ERT target, it should use that target’s Embedded-C code format, and should inherit the options defined in the ERT target’s system target file. By following these recommendations, your target has all the production code generation capabilities of the ERT target.

See “Customize System Target Files” on page 24-36 for further details on the inheritance mechanism, setting the code format, and other details.

- The most fundamental requirement for an embedded target is that it generate a real-time executable from a model or subsystem. Typically, an embedded target generates a timer interrupt-based, bareboard executable (although targets can be developed for an operating system environment as well).

Your target should support the Simulink Coder concepts of single-tasking and multitasking solver modes for model execution. Tasking support comes almost “for free” with the ERT target, but you should thoroughly understand how it works before implementing an ERT-based target.

Implementation of timer interrupt-based execution is documented in “Scheduling” on page 1-4 and “Time-Based Scheduling”.

- You should generate the target executable's main program module, rather than using a static main module (such as the static `ert_main.c` module provided with the Embedded Coder product). A generated `main.c` or `.cpp` can be made much more readable and more efficient, since it omits preprocessor checks and other extra code.

See “Standalone Programs (No Operating System)” for information on generated and static main program modules.

- Follow the guidelines in “Folder and File Naming Conventions” on page 24-11.

### **Integration with Target Development Environments**

- Most cross-development systems run under a Microsoft Windows PC host. Your target should support the Windows XP operating system as the host environment.

Some cross-development systems support one or more versions of The Open Group UNIX platforms, allowing for UNIX host support as well.

- Your embedded target must support at least one embedded development environment. The interface to a development environment can take one of several forms. The most common approach is to use a template makefile to generate standard makefiles with the `make` utility provided with your development environment. “Customize Template Makefiles” on page 24-75 describes the structure of template makefiles.

Another approach with IDE-based tools is project file creation and/or Microsoft Windows Component Object Model (COM) automation.

It is important to consider the license requirements and restrictions of the development environment vendor. You may need to modify files provided by the vendor and ship them as part of the embedded target.

See “Interface to Development Tools” on page 24-123 for further information.

### **Observing Execution of Target Code**

- Your target should support a mechanism you can use to observe the target code as it runs in real time (outside of a debugger).



You can use the `rtiostream` API to implement a communication channel to enable exchange of data between different processes. See the Web page example here “Creating a Communications Channel for Target Connectivity”. This `rtiostream` communication channel is required to enable processor-in-the-loop (PIL) on a new target. See “Communications `rtiostream` API” in the Embedded Coder documentation.

One industry-standard approach is to use the CAN bus, with an ASAP2 file and CAN Calibration Protocol (CCP). There are several host-based graphical front-end tools available that connect to a CCP-enabled target and provide data viewing and parameter tuning. Supporting these tools requires implementation of CAN hardware drivers and CCP protocol for the target, as well as ASAP2 file generation. Your target can leverage the ASAP2 support provided with the Embedded Coder product.

Another option is to support Simulink External mode over a serial interface (RS-232). See the “Host/Target Communication” on page 15-50 for information on using the External mode API.

## Deployment and Hardware Issues

- Device driver support is an important issue in the design of an embedded target. Device drivers are Simulink blocks that support either hardware I/O capabilities of the target CPU, or I/O features of the development board.

If you are developing a rapid prototyping target, consider providing minimal driver support, on the assumption that end users develop their own drivers. If you are developing a turnkey production target, you should provide full driver support.

See “Integrate Device Drivers” on page 24-135.

- Automatic download of generated code to the target hardware makes a target easier to use. Typically a debugger utility is used; if the chosen debugger supports command script files, this can be straightforward to implement. “STF\_make\_rtw\_hook.m” on page 24-23 describes a mechanism to execute code from the build process. You can use this mechanism to make `system()` calls to invoke utilities such as a debugger. You can invoke other simple downloading utilities in a similar fashion.

If your development system supports COM automation, you can control the download process by that mechanism. Using COM automation is discussed in “Interface to Development Tools” on page 24-123.

- Executables that are mapped to RAM memory are typical. You can provide optional support for FLASH or RAM placement of the executable by using your target’s code generation options. To support this capability, you might need multiple linker command files, multiple debugger scripts, and possibly multiple makefiles or project files. Also include the ability to automatically switch between these files, depending on the RAM/FLASH option value.
- Select a popular, widely available evaluation or prototype board for your target processor. Consider enclosed and ruggedized versions of the target board. Also consider board level support for the various on-chip I/O capabilities of the target CPU, and the availability of development systems that support the selected board.

## Sample Custom Targets

There are technical solutions on the MathWorks Web site that you can use as a starting point to create your own target solution. The solutions provide guides to the following tasks for creating custom targets:

- Methods of embedding code onto a custom processor
- Creating a system target file
- Customizing the makefile and main file
- Adding compiler, chip, and board specific information
- Integrating legacy code and device drivers
- Creating blocks and libraries
- Implementing processor-in-the-loop (PIL) testing.

**1** Start by downloading the technical solution on this web page:

Solution 1-BHU00D — An example guide to developing an embedded target

This solution provides example files and a guide to developing a custom embedded target. The guide is divided into two parts, one on creating a generic custom target and another on creating a target for the Freescale™ S12X processor using the Cosmic Compiler.

Read the example guide along with this document to understand the tasks for developing embedded targets.

**2** For more detailed example files for specific processors, see:

- Solution ID 1-9RXFT3 — An example Freescale S12X target using the Cosmic Compiler
- Solution ID 1-BHT815 — An example Freescale S12X target using the CodeWarrior® Compiler

These example kits contain example models, code generation files, and instruction guides on generating and testing code for the processor.

The Cosmic example illustrates the use of the target connectivity API for processor-in-the-loop (PIL) testing. The CodeWarrior example does

not have PIL but shows CAN Calibration Protocol (CCP) and Simulink External mode.

The intent of the example kits is to provide working examples that you can use as a base to create your own target solution. The intent is not to provide a full featured and maintained Embedded Target product like those provided by MathWorks or third-party products, as listed on the supported hardware Web page:  
<http://www.mathworks.com/products/embedded-coder/supportededio.html>.

**3** You can watch videos showing overviews of both the example kits at the following links:

- [www.mathworks.com/products/demos/rtwembedded/S12X\\_final\\_generic/](http://www.mathworks.com/products/demos/rtwembedded/S12X_final_generic/)
- [www.mathworks.com/products/demos/rtwembedded/STR9\\_final\\_multi/](http://www.mathworks.com/products/demos/rtwembedded/STR9_final_multi/)

For another example target for the ARM9 (STR9) processor, see Solution ID 1-BBT4ID — An example ARM<sup>®</sup>9 (STR9) target using the GNU ARM Compiler and Hitex STR9-comStick.

If you have questions on specific targets, please email [mytarget@mathworks.com](mailto:mytarget@mathworks.com).

The example kits and this document describe Embedded Coder features such as customized ert system target files and processor-in-the-loop testing, but you can study the examples as a starting point for use with Simulink Coder targets.

# Target Development Mechanics

## In this section...

“Folder and File Naming Conventions” on page 24-11

“Components of a Custom Target” on page 24-12

“Key Folders Under Target Root (mytarget)” on page 24-17

“Key Files in Target Folder (mytarget/mytarget)” on page 24-20

“Additional Files for Externally Developed Targets” on page 24-28

“Target Development and the Build Process” on page 24-29

## Folder and File Naming Conventions

You can use a single folder for your custom target files, or if desired you can use subfolders, for example containing files associated with specific development environments or tools.

For a custom target implementation, the recommended folder and file naming conventions are

- Use *only* lowercase in all folder names, filenames, and extensions.
- Do not embed spaces in folder names. Spaces in folder names cause errors with many third-party development environments.
- Include desired folders in the MATLAB path
- Do *not* place your custom target folder anywhere in the MATLAB folder tree (that is, in or under the *matlabroot* folder). If you place your folder under *matlabroot* you risk losing your work if you install a new MATLAB version (or reinstall the current version).

The following sections explain how to organize your target folders and files and add them to the your MATLAB path. They also provide high-level descriptions of the files.

In this document, `mytarget` is a placeholder name that represents folders and files that use the target’s name. The names `dev_tool1`, `dev_tool2`, and so on represent subfolders containing files associated with development

environments or tools. This document describes an example structure where the folder `mytarget` contains subfolders for `mytarget`, `blocks`, `dev_tool1`, `dev_tool2`. The top level folder `mytarget` is the *target root folder*.

## Components of a Custom Target

- “Overview” on page 24-12
- “Code Components” on page 24-13
- “Control Files” on page 24-15

### Overview

The components of a custom target are files located in a hierarchy of folders. The top-level folder in this structure is called the *target root folder*. The target root folder and its contents are named, organized, and located on the MATLAB path according to conventions described in “Folder and File Naming Conventions” on page 24-11.

The components of a custom target include

- Code components: C source code that supervises and supports execution of generated model code.
- Control files:
  - A system target file (STF) to control the code generation process.
  - File(s) to control the building of an executable from the generated code. In a traditional make-based environment, a template makefile (TMF) generates a makefile for this purpose. Another approach is to generate project files in support of a modern integrated development environment (IDE) such as the Freescale Semiconductor CodeWarrior IDE.
  - Hook files: Optional TLC and `.m` files that can be invoked at well-defined stages of the build process. Hook files let you customize the build process and communicate information between various phases of the process.
- Target preferences files: These files define a *target preferences class* associated with your target. Your target preference class lets you create data objects that define and store properties associated with your target.

For example, you may want to store a user-defined path to a cross-compiler that is invoked by the build process.

- Other target files: Files that let you integrate your target into the MATLAB environment. For example, you can provide an `info.xml` file to make your target block libraries, examples, and target preferences available from a MATLAB session.

The next sections introduce key concepts and terminology you need to know to develop each component. References to more detailed information sources are provided.

## Code Components

A Simulink Coder program containing code generated from a Simulink model consists of a number of code modules and data structures. These fall into two categories.

**Application Components.** Application components are those which are specific to a particular model; they implement the functions represented by the blocks in the model. Application components are not specific to the target. Application components include

- Modules generated from the model
- User-written blocks (S-functions)
- Parameters of the model that are visible, and can be interfaced to, external code

**Execution Support Files.** A number of code modules and data structures, referred to collectively as the *execution support files*, are responsible for managing and supporting the execution of the generated program. The execution support files modules are not automatically generated. Depending on the requirements of your target, you must implement certain parts of the execution support files. Execution Support Files on page 24-14 summarizes the execution support files.

## Execution Support Files

You Provide...	The Simulink Coder Software Provides...
Customized main program	Generic main program
Timer interrupt handler to run model	Execution engine and integration solver (called by timer interrupt handler)
Other interrupt handlers	Example interrupt handlers (Asynchronous Interrupt blocks)
Device drivers	Example device drivers
Data logging, parameter tuning, signal monitoring, and External mode support	Data logging, parameter tuning, signal monitoring, and External mode APIs

**User-Written Execution Support Files.** The Simulink Coder software provides most of the execution support files. Depending on the requirements of your target, you must implement some or all of the following elements:

- A timer *interrupt service routine* (ISR). The timer runs at the program's base sample rate. The timer ISR is responsible for operations that must be completed within a single clock period, such as computing the current output sample. The timer ISR usually calls the Simulink Coder `rt_OneStep` function.

If you are targeting a real-time operating system (RTOS), your generated code usually executes under control of the timing and task management mechanisms provided by the RTOS. In this case, you may not have to implement a timer ISR.

- The *main program*. Your main program initializes the blocks in the model, installs the timer ISR, and executes a background task or loop. The timer periodically interrupts the main loop. If the main program is designed to run for a finite amount of time, it is also responsible for cleanup operations — such as memory deallocation and masking the timer interrupt — before terminating the program.



If you are targeting a real-time operating system (RTOS), your main program most likely spawns tasks (corresponding to the sample rates used in the model) whose execution is timed and controlled by the RTOS.

Your main program typically is based on the Embedded Coder main program, `ert_main.c`. “Standalone Programs (No Operating System)” details the structure of the Embedded Coder execution support files and the execution of Embedded Coder code, and provides guidelines for customizing `ert_main.c`.

- *Device drivers.* Drivers communicate with I/O devices on your target hardware. In production code, device drivers are normally implemented as inlined S-functions.
- *Other interrupt handlers.* If your models need to support asynchronous events, such as hardware generated interrupts and asynchronous read and write operations, you must supply interrupt handlers. The Simulink Coder Interrupt Templates library provides examples.
- *Data logging, parameter tuning, signal monitoring, and External mode support.* It is atypical to implement rapid prototyping features such as External mode support in an embedded target. However, it is possible to support these features by using standard Simulink Coder APIs. See “Data Exchange” on page 15-50 for details.

## Control Files

The code generation and build process is directed by a number of TLC and MATLAB files collectively called *control files*. This section introduces and summarizes the main control files.

**Top-Level Control File (`make_rtw`).** The build process is initiated when you click **Build** (or type **Ctrl+B**). At this point, Simulink Coder build process parses the **Make command** field of the **Code Generation** pane of the Configuration Parameters dialog box, expecting to find the name of a top-level MATLAB file command that controls the build process (as well as optional arguments to that command). The default top-level control file for the build process is `make_rtw.m`.

Normally, target developers do not need detailed knowledge of how `make_rtw` works. (The details for target developers are described in “Target Development and the Build Process” on page 24-29.) You should not customize

`make_rtw.m`. The `make_rtw.m` file contains all the logic required to execute your target-specific control files, including a number of hook points for execution of your custom code.

`make_rtw` does the following:

- Passes optional arguments in to the build process
- Performs any required preprocessing before code generation
- Executes the STF to perform code generation (and optional HTML report generation)
- Processes the TMF to generate a makefile
- Invokes a make utility to execute the makefile and build an executable
- Performs any required post-processing (such as generating calibration data files or downloading the generated executable to the target)

**System Target File (STF).** The Target Language Compiler (TLC) generates target-specific C or C++ code from an intermediate description of your Simulink block diagram (`model.rtw`). The Target Language Compiler reads `model.rtw` and executes a program consisting of several target files (`.tlc` files.) The STF, at the top level of this program, controls the code generation process. The output of this process is a number of source files, which are fed to your development system's make utility.

You need to create a customized STF to set code generation parameters for your target. You should copy, rename, and modify the standard ERT system target file (`matlabroot/rtw/c/ert/ert.tlc`).

The detailed structure of the STF is described in “Customize System Target Files” on page 24-36.

**Template Makefile (TMF).** A TMF provides information about your model and your development system. The build process uses this information to create a makefile (`.mk` file) that builds an executable program.

Some targets implement more than one TMF, in order to support multiple development environments (for example, two or more cross-compilers)

or multiple modes of code generation (for example, generating a binary executable vs. generating a project file for your compiler).

The Embedded Coder software provides a large number of TMFs suitable for different types of host-based development systems. These TMFs are located in `matlabroot/rtw/c/ert`. The standard TMFs are described in the “Template Makefiles and Make Options” on page 9-38 section of the Simulink Coder documentation.

The detailed structure of the TMF is described in “Customize Template Makefiles” on page 24-75.

**Hook Files.** Simulink Coder build process allows you to supply optional *hook files* that are executed at specified points in the code generation and make process. You can use hook files to add target-specific actions to the build process.

The hook files must follow well-defined naming and location requirements. “Folder and File Naming Conventions” on page 24-11 describes these requirements.

## Key Folders Under Target Root (mytarget)

- “Target Root Folder (mytarget)” on page 24-17
- “Target Folder (mytarget/mytarget)” on page 24-18
- “Target Block Folder (mytarget/blocks)” on page 24-18
- “Development Tools Folder (mytarget/dev\_tool1, mytarget/dev\_tool2)” on page 24-20
- “Target Preferences Folder (mytarget/mytarget/@mytarget)” on page 24-20
- “Target Source Code Folder (mytarget/src)” on page 24-20

### Target Root Folder (mytarget)

This folder contains the key subfolders for the target (see “Folder and File Naming Conventions” on page 24-11). You can also locate miscellaneous files (such as a `readme` file) in the target root folder. The following sections describe required and optional subfolders and their contents.

### **Target Folder (mytarget/mytarget)**

This folder contains files that are central to the target, such as the system target file (STF) and template makefile (TMF). “Key Files in Target Folder (mytarget/mytarget)” on page 24-20 summarizes the files that should be stored in mytarget/mytarget, and provides pointers to detailed information about these files.

---

**Note** mytarget/mytarget should be on the MATLAB path.

---

### **Target Block Folder (mytarget/blocks)**

If your target includes device drivers or other blocks, locate the block implementation files in this folder. mytarget/blocks contains

- Compiled block MEX-files
- Source code for the blocks
- TLC inlining files for the blocks
- Library models for the blocks (if you provide your blocks in one or more libraries)

---

**Note** mytarget/blocks should be on the MATLAB path.

---

You can also store example models and any supporting files in mytarget/blocks. Alternatively, you can create a mytarget/mytargetdemos folder, which should also be on the MATLAB path.

To display your blocks in the standard Simulink Library Browser and/or integrate your example models into the MATLAB session environment, you can create the files described below and store them in mytarget/blocks.

**mytarget/blocks/slblocks.m.** This file allows a group of blocks to be integrated into the Simulink Library and Simulink Library Browser.

## Example sblocks.m File

```
function blkStruct = sblocks
% Information for "Blocksets and Toolboxes" subsystem
blkStruct.Name = sprintf('Embedded Target\n for MYTARGET');
blkStruct.OpenFcn = 'mytargetlib';
blkStruct.MaskDisplay = 'disp(''MYTARGET'')';

% Information for Simulink Library Browser
Browser(1).Library = 'mytargetlib';
Browser(1).Name = 'Embedded Target for MYTARGET';
Browser(1).IsFlat = 1;% Is this library "flat" (i.e. no subsystems)?

blkStruct.Browser = Browser;
```

**mytarget/blocks/demos.xml.** This file provides information about the components, organization, and location of example models. MATLAB software uses this information to place the example in the MATLAB session environment.

## Example demos.xml File

```
<?xml version="1.0" encoding="utf-8"?>
<demos>
  <name>Embedded Target for MYTARGET</name>
  <type>simulink</type>
  <icon>$toolbox/matlab/icons/boardicon.gif</icon>
  <description source = "file">mytarget_overview.html</description>

  <demosession>
    <label>Multirate model</label>
    <demoitem>
      <label>MYTARGET demo</label>
      <file>mytarget_overview.html</file>
      <callback>mytarget_model</callback>
    </demoitem>
  </demosession>

</demos>
```

### **Development Tools Folder (mytarget/dev\_tool1, mytarget/dev\_tool2)**

These folders contain files associated with specific development environments or tools (dev\_tool1, dev\_tool2, etc.). Normally, your target supports at least one such development environment and invokes its compiler, linker, and other utilities during the build process. mytarget/dev\_tool1 includes linker command files, startup code, hook functions, and any other files required to support this process.

For each development environment, you should provide a separate folder.

You should use the target preferences mechanism to store information about a user's choice of development environment or tool, paths to the installed development tools, and so on. Using target preferences data in this way, lets your build process code select a development environment and invoke a compiler and other utilities for your target platform. See the code excerpt in "mytarget\_default\_tmf.m Example Code" on page 24-89 for an example of how to use target preferences data for this purpose.

### **Target Preferences Folder (mytarget/mytarget/@mytarget)**

If you create a target preferences class to store information about user preferences, you should store data class definition files and other files that support your target-specific preferences in mytarget/mytarget/@mytarget. The Simulink Data Class Designer creates the @mytarget folder automatically within the parent folder.

### **Target Source Code Folder (mytarget/src)**

This folder is optional. If the complexity of your target requires it, you can use mytarget/src to store any common source code and configuration code (such as boot and startup code).

### **Key Files in Target Folder (mytarget/mytarget)**

- "Introduction" on page 24-21
- "mytarget.tlc" on page 24-21
- "mytarget.tmf" on page 24-22

- “mytarget\_default\_tmf.m” on page 24-22
- “mytarget\_settings.tlc” on page 24-22
- “mytarget\_genfiles.tlc” on page 24-22
- “mytarget\_main.c” on page 24-23
- “STF\_make\_rtw\_hook.m” on page 24-23
- “STF\_wrap\_make\_cmd\_hook.m” on page 24-23
- “STF\_rtw\_info\_hook.m (obsolete)” on page 24-26
- “info.xml” on page 24-27
- “mytarget\_overview.html” on page 24-28

## Introduction

The target folder `mytarget/mytarget` contains key files in your target implementation. These include the system target file, template makefile, main program module, and optional M and TLC hook files that let you add target-specific actions to the build process. The following sections describe the key target folder files.

## **mytarget.tlc**

`mytarget.tlc` is the system target file (STF). Functions of the STF include

- Making the target visible in the System Target File Browser
- Definition of code generation options for the target (inherited and target-specific)
- Providing an entry point for the top-level control of the TLC code generation process

You should base your STF on `ert.tlc`, the STF provided by the Embedded Coder software.

“Customize System Target Files” on page 24-36 gives detailed information on the structure of the STF, and also gives instructions on how to customize an STF to

- Display your target in the System Target File Browser
- Add your own target options to the Configuration Parameters dialog box
- Tailor the code generation and build process to the requirements of your target

### **mytarget.tmf**

`mytarget.tmf` is the template makefile for building an executable for your target.

For basic information on the structure and operation of template makefiles, see “Customize Template Makefiles” on page 24-75.

If your target development environment requires automation of a modern integrated development environment (IDE) rather than use of a traditional make utility, see “Interface to Development Tools” on page 24-123.

You might create multiple template makefiles to support different development environments. See “Supporting Multiple Development Environments” on page 24-60 and “`mytarget_default_tmf.m` Example Code” on page 24-89 for information.

### **mytarget\_default\_tmf.m**

This file is optional. You can implement a `mytarget_default_tmf.m` file to select a template makefile, based on user preferences. See “Setting Up a Template Makefile” on page 24-88.

### **mytarget\_settings.tlc**

This file is optional. Its purpose is to centralize global settings in the code generation environment. See “Using `mytarget_settings.tlc`” on page 24-55 for details.

### **mytarget\_genfiles.tlc**

This file is optional. `mytarget_genfiles.tlc` is useful as a central file from which to invoke any target-specific TLC files that generate additional files as part of your target build process. For example, your target may create sub-makefiles or project files for a development environment, or



command scripts for a debugger to do automatic downloads. See “Using mytarget\_genfiles.tlc” on page 24-58 for details.

### **mytarget\_main.c**

A main program module is required for your target. To provide a main module, you can either

- Modify the `ert_main.c` module provided by the Embedded Coder software
- Generate `mytarget_main.c` or `.cpp` during the build process

“Standalone Programs (No Operating System)” contains a detailed description of the operation of `ert_main.c`. The section also contains guidelines for generating and modifying a main program module.

### **STF\_make\_rtw\_hook.m**

`STF_make_rtw_hook.m` is an optional hook file that you can use to invoke target-specific functions or executables at specified points in the build process. `STF_make_rtw_hook.m` implements a function that dispatches to a specific action depending on the `method` argument that is passed into it.

“Customize Build Process with STF\_make\_rtw\_hook File” on page 22-21 describes the operation of the `STF_make_rtw_hook.m` hook file in detail.

### **STF\_wrap\_make\_cmd\_hook.m**

Use this file to override the default Simulink Coder behavior for selecting the compiler tool to be used in the build process.

By default, the Simulink Coder build process is based on makefiles. On PC hosts, the build process creates `model.bat`, an MS-DOS batch file. `model.bat` sets up the environment variables for the compiler, linker, and other utilities, and invokes a `make` utility. The batch file, `model.bat`, obtains the required environment variable settings from the `MAKECMD` field in the template makefile. The standard Simulink Coder template makefiles support only standard compilers that build executables on the host system.

When developing an embedded target, you often need to override these defaults. Typically, you need to support one or more target-specific

cross-development systems, rather than supporting compilers for the host system. The `STF_wrap_make_cmd_hook` mechanism provides a way to set up an environment specific to an embedded development tool.

Note that the naming convention for this file is *not* based on the target name. It is based on the concatenation of the system target filename, `STF`, with the string `'_wrap_make_cmd_hook'`.

**Stub makefiles.** Many modern cross-development systems, such as the Freescale Semiconductor CodeWarrior development environment, are based on project files rather than makefiles. If the interface to the embedded development system is not makefile based, one recommended approach is to create a stub makefile. When the build process invokes the stub makefile, no action takes place.

**STF\_wrap\_make\_cmd\_hook Mechanism.** A recommended approach to supporting non-host-based development systems is to provide a hook file that is called instead of the default host-based compiler selection.

To do this, create a `STF_wrap_make_cmd_hook.m` file. If this file exists, the build process calls it instead of the default compiler selection process. Check that:

- The file is on the MATLAB path.
- The filename is the name of your STF, prepended to the string `'_wrap_make_cmd_hook.m'`.
- The hook function implemented in the file follows the function prototype shown in the code example below.

A typical approach would be to write a `STF_wrap_make_cmd_hook.m` file that creates a MS-DOS batch file (`model.bat`). The batch file first sets up environment variables for the embedded target development system. Then, it invokes the embedded target's make utility on the generated makefile. The `STF_wrap_make_cmd_hook` function should return a system command that invokes `model.bat`.

This approach is shown in “Example STF\_wrap\_make\_cmd\_hook Function” on page 24-26.

Alternatively, any MS-DOS batch file can be created by `STF_wrap_make_cmd_hook`, and the function can return any command; it is not limited to `model.bat`. Like the `exit` case of the `STF_make_rtw_hook` mechanism, this provides the flexibility to invoke other utilities or applications.

On a PC host, the build process checks the standard output (STDOUT) for a build success string. By default, the string is

```
"### Created"
```

You can change this specifying a different `BUILD_SUCCESS` variable in the template makefile.

**Example STF\_wrap\_make\_cmd\_hook Function.**

```
function makeCmdOut = stfname_wrap_make_cmd_hook(args)
    makeCmd      = args.makeCmd;
    modelName    = args.modelName;
    verbose      = args.verbose;

    % args.compilerEnvVal not used
    cmdFile = ['.\'',modelName, '.bat'];
    cmdFileFid = fopen(cmdFile,'wt');
    if ~verbose
        fprintf(cmdFileFid, '@echo off\n');
    end

    try
        prefs = RTW.TargetPrefs.load('mytarget.prefs');
        catch exception
            rethrow(exception);
        end

    fprintf(cmdFileFid, '@set TOOL_VAR1=%s\n', prefs.ImpPath);
    fprintf(cmdFileFid, '@set TOOL_VAR2=x86-win32\n');
    toolRoot = fullfile(prefs.ImpPath,'host','tool','4.4b');
    fprintf(cmdFileFid, '@set TOOL_VAR3=%s\n', toolRoot);
    path = getenv('Path');
    path1 = fullfile(prefs.ImpPath,'host','license;');
    if ~isempty(strfind(path,path1)) path1 = ''; end
    fprintf(cmdFileFid, '@set Path=%s%s\n', path1, path);
    fullMakeCmd = fullfile(prefs.ImpPath,'host','tool',...
        'bin', makeCmd);
    fprintf(cmdFileFid, '%s\n', fullMakeCmd);
    fclose(cmdFileFid);
    makeCmdOut = cmdFile;
```

**STF\_rtw\_info\_hook.m (obsolete)**

Prior to Release 14, custom targets supplied target-specific information with a hook file (referred to as *STF\_rtw\_info\_hook.m*). The *STF\_rtw\_info\_hook* specified properties such as word sizes for integer data types (for example,

char, short, int, and long), and C implementation-specific properties of the custom target.

The `STF_rtw_info_hook` mechanism has been replaced by the **Hardware Implementation** pane of the Configuration Parameters dialog box. Using this dialog box, you can specify all properties that were formerly specified in your `STF_rtw_info_hook` file.

For backward compatibility, existing `STF_rtw_info_hook` files are still available. However, you should convert your target and models to use the **Hardware Implementation** pane. See “Hardware Targets” on page 9-9.

### info.xml

This file provides information to MATLAB software that specifies where to display the target toolbox in the MATLAB session environment.

**Example info.xml File.** This example shows you how to set up access to a target’s example page and target preferences GUI from the MATLAB session environment.

```
<productinfo>

<matlabrelease>13</matlabrelease>
<name>Embedded Target for MYTARGET</name>
<type>simulink</type>
<icon>$toolbox/simulink/simulink/simulinkicon.gif</icon>

<list>

<listitem>
<label>Demos</label>
<callback>demo simulink 'Embedded Target for MYTARGET'</callback>
<icon>$toolbox/matlab/icons/demoicon.gif</icon>
</listitem>

<listitem>
<label>MYTARGET Target Preferences</label>
<callback>mytargetTargetPrefs =
RTW.TargetPrefs.load('mytarget.prefs');
```

```
gui(mytargetTargetPrefs); </callback>
<icon>$toolbox/simulink/simulink/simulinkicon.gif</icon>
</listitem>

</list>
</productinfo>
```

### **mytarget\_overview.html**

By convention, this file serves as home page for the target examples.

The <description> field in `demos.xml` should point to `mytarget_overview.html` (see “mytarget/blocks/demos.xml” on page 24-19).

### **Example mytarget\_overview.html File.**

```
<html>
<head><title>Embedded Target for MYTARGET</title></head><body>
<p style="color:#990000; font-weight:bold; font-size:x-large">Embedded Target
for MYTARGET Example Model</p>

<p>This example provides a simple model that allows you to generate an executable
for a supported target board. You can then download and run the executable and
set breakpoints to study and monitor the execution behavior.</p>

</body>
</html>
```

## **Additional Files for Externally Developed Targets**

- “Introduction” on page 24-28
- “mytarget/mytarget/mytarget\_setup.m” on page 24-29
- “mytarget/mytarget/doc” on page 24-29

### **Introduction**

If you are developing an embedded target that is not installed into the MATLAB tree, you should provide a target setup script and target

documentation within `mytarget/mytarget`, for the convenience of your users. The following sections describe the required materials and where to place them.

### **mytarget/mytarget/mytarget\_setup.m**

This file script adds paths for your target to the MATLAB path. Your documentation should instruct users to run the script when installing the target.

You should include a call to the MATLAB function `savepath` in your `mytarget_setup.m` script. This function saves the added paths, so users need to run `mytarget_setup.m` only once.

The following code is an example `mytarget_setup.m` file.

```
function mytarget_setup()
curpath = pwd;
tgtpath = curpath(1:end-length('\mytarget'));
addpath(fullfile(tgtpath, 'mytarget'));
addpath(fullfile(tgtpath, 'dev_tool1'));
addpath(fullfile(tgtpath, 'blocks'));
addpath(fullfile(tgtpath, 'mytargetdemos'));
savepath;
disp('MYTARGET Target Path Setup Complete.');
```

### **mytarget/mytarget/doc**

You should put all documentation related to your target in the folder `mytarget/mytarget/doc`.

## **Target Development and the Build Process**

- “About the Build Process” on page 24-30
- “Build Process Phases and Information Passing” on page 24-30
- “Additional Information Passing Techniques” on page 24-32

## About the Build Process

To develop an embedded target, you need a thorough understanding of the Simulink Coder build process. Your embedded target uses the build process and may require you to modify or customize the process. A general overview of code generation and the build process is given in “Source Code Generation” and “Program Builds”.

This section supplements that overview with a description of the build process as customized by the Embedded Coder software. The emphasis is on points in the process where customization hooks are available and on passing information between different phases of the process.

This section concludes with “Additional Information Passing Techniques” on page 24-32, describing assorted tips and tricks for passing information during the build process.

## Build Process Phases and Information Passing

It is important to understand where (and when) the build process obtains required information. Sources of information include

- The *model.rtw* file, which provides information about the generating model. All information in *model.rtw* is available to target TLC files.
- The Simulink Coder related panes of the Configuration Parameters dialog box. Options (both general and target-specific) are provided through check boxes, menus, and edit fields. You can associate options with TLC variables and makefile tokens in the *rtwoptions* data structure.
- The target preferences data. Target preferences provide persistent information about the target, such as the location of your development tools.
- The template makefile (TMF), which generates the model-specific makefile.
- Environment variables on the host computer. Environment variables provide additional information about installed development tools.
- Other target-specific files such as target-related TLC files, linker command files, or project files.



It is also important to understand the several phases of the build process and how to pass information between the phases. The build process comprises several high-level phases:

- Execution of the top-level file (`slbuild.m` or `rtwbuild.m`) to sequence through the build process for a target
- Conversion of the model into the TLC input file (`model.rtw`)
- Generation of the target code by the TLC compiler
- Compilation of the generated code with `make` or other utilities
- Transmission of the final generated executable to the target hardware with a debugger or download utility

It is helpful to think of each phase of the process as a different “environment” that maintains its own data. These environments include

- MATLAB code execution environment (MATLAB)
- Simulink
- Target Language Compiler execution environment
- `makefile`
- Development environments such as an IDE or debugger

In each environment, you might get information from the various sources mentioned above. For example, during the TLC phase, execute MATLAB file might execute to obtain information from the MATLAB environment. Also, a given phase may generate information for a subsequent phase.

See “Key Files in Target Folder (`mytarget/mytarget`)” on page 24-20 for details on the available MATLAB file and TLC hooks for information passing, with code examples.

## **Additional Information Passing Techniques**

This section describes a number of useful techniques for passing information among different phases of the build process.

**tlcvariable Field in rtwoptions Structure.** Options on the Simulink Coder related panes of the Configuration Parameters dialog box can be associated with a TLC variable, and specified in the `tlcvariable` field of the option's entry in the `rtwoptions` structure. The variable value is passed on the command line when TLC is invoked. This provides a way to make Simulink Coder options and their values available in the TLC phase.

See "System Target File Structure" on page 24-37 for further information.

**makevariable Field in rtwoptions Structure.** Similarly, Simulink Coder options can be associated with a template makefile token, specified in the `makevariable` field of the option's entry in the `rtwoptions` structure. If a token of the same name as the `makevariable` name exists in the TMF, the token is updated with the option value when the final makefile is created. If the token does not exist in the TMF, the `makevariable` is passed in on the command line when `make` is invoked. Thus, in either case, the `makevariable` is available to the makefile.

See "System Target File Structure" on page 24-37 for further information.

**Accessing Host Environment Variables.** You can access host shell environment variables at the MATLAB command line by entering the `getenv` command. For example:

```
getenv ('MSDEVDIR')
```

```
ans =
```

```
D:\Applications\Microsoft Visual Studio\Common\MSDev98
```

To access the same information from TLC, use the `FEVAL` directive to invoke `getenv`.

```
%assign eVar = FEVAL("getenv", "<varname>").
```

**Supplying Development Environment Information to Your Template Makefile.** An embedded target must tie the build process to target-specific development tools installed on a host computer. For the make process to run these tools, the TMF must be able to determine the name of the tools, the path to the compiler, linker, and other utilities, and possibly the host operating system environment variable settings. This section describes two techniques for supplying this information.

The simpler, more traditional approach is to require the end user to modify the target TMF. The user enters path information (such as the location of a compiler executable), and possibly host operating system environment variables, as make variables. This allows the TMF to be tailored to specific needs.

This approach is not satisfactory in an environment where the MATLAB installation is on a network and multiple users share read-only TMFs. Another possible drawback to this approach is that the tool information is only available during the makefile processing phase of the build process.

A second approach is to use the target preferences feature together with the *STF\_wrap\_make\_cmd\_hook* mechanism (see “*STF\_wrap\_make\_cmd\_hook* Mechanism” on page 24-24). In this approach, compiler and other tool path information is stored as preferences data, which is obtained by the *STF\_wrap\_make\_cmd\_hook.m* file. This allows tool path information to be saved separately for each user.

Another advantage to the second approach is that target preferences data is available to all phases of the build process, including the TLC phase. This information may be required to support features such as RAM/ROM profiling.

**Using MATLAB Application Data.** Application data provides a way for applications to save and retrieve data stored with the GUI. This technique enables you to create what is essentially a user-defined property for an object, and use this property to store data for use in the build process. If you are unfamiliar with this technique, see the “Application Data” section of the MATLAB documentation of creating graphical user interfaces.

The following code examples illustrate the use of application data to pass information to TLC.

This file, `tlc2appdata.m`, stores the data passed in as application data under the name passed in (`appDataName`).

```
function k = tlc2appdata(appDataName, data)
    disp([mfilename, ': ', appDataName, ' ', data]);
    setappdata(0, appDataName, data);
    k = 0; % TLC expects a return value for FEVAL.
```

The following sample TLC file uses the FEVAL directive to invoke `tlc2appdata.m` to store arbitrary application data, under the name `z80`.

```
%% test.tlc
%%
%assign myApp = "z80"
%assign myData = "314159"
%assign dummy = FEVAL("tlc2appdata", myApp, myData)
```

To test this technique:

- 1** Create the `tlc2appdata.m` file as shown. Check that `tlc2appdata.m` is stored in a folder on the MATLAB path.
- 2** Create the TLC file as shown. Save it as `test.tlc`.
- 3** Enter the following command at the MATLAB prompt to execute the TLC file:

```
tlc test.tlc
```

- 4** Get the application data at the MATLAB prompt:

```
k = getappdata(0, 'z80')
```

The function returns the value 314159.

**5** Enter the following command.

```
who
```

Note that application data is not stored in the MATLAB workspace. Also observe that the z80 data is not visible. Using application data in this way has the advantage that it does not clutter the MATLAB workspace. Also, it helps prevent you from accidentally deleting your data, since it is not stored directly in the your workspace.

A real-world use of application data might be to collect information from the *model.rtw* file and store it for use later in the build process.

**Adding Block-Specific Information to the Makefile.** The `rtwmakecfg` mechanism provides a method for inlined S-functions such as driver blocks to add information to the makefile. This mechanism is described in “Using the `rtwmakecfg.m` API to Customize Generated Makefiles” on page 24-92.

## Customize System Target Files

### In this section...

“Control Code Generation With the System Target File” on page 24-36

“System Target File Naming and Location Conventions” on page 24-37

“System Target File Structure” on page 24-37

“Define and Display Custom Target Options” on page 24-46

“Tips and Techniques for Customizing Your STF” on page 24-54

“Create a Custom Target Configuration” on page 24-61

### Control Code Generation With the System Target File

The system target file (STF) exerts overall control of the code generation stage of the build process. The STF also lets you control the presentation of your target to the end user. The STF provides

- Definitions of variables that are fundamental to the build process, such as code format to be generated
- The main entry point to the top-level TLC program that generates code
- Target information for display in the System Target File Browser
- A mechanism for defining target-specific code generation options (and other parameters affecting the build process) and for displaying them in the Configuration Parameters dialog box

---

**Note** You can save a configuration set with custom options to a MAT-file. However, when you load the MAT-file, some custom options might not appear in the Configuration Parameters dialog box.

---

- A mechanism for inheriting options from another target (such as the Embedded Real-Time (ERT) target)

This chapter provides information on the structure of the STF, guidelines for customizing an STF, and a basic tutorial that helps you get a skeletal STF up and running.

Note that, although the STF is a Target Language Compiler (TLC) file, it contains embedded MATLAB code. Before creating or modifying an STF, you should acquire a working knowledge of TLC and of the MATLAB language. “Target Language Compiler” and “Scripts vs. Functions” describe the features and syntax of both the TLC and MATLAB languages.

While reading this chapter, you may want to refer to the STFs provided with the Simulink Coder product. Most of these files are stored in the target-specific folders under *matlabroot*/rtw/c. Additional STFs are stored under *matlabroot*/toolbox/rtw/targets.

## System Target File Naming and Location Conventions

An STF must be located in a folder on the MATLAB path for the target to be displayed in the System Target File Browser and invoked in the build process. Follow the location and naming conventions for STFs and related target files given in “Folder and File Naming Conventions” on page 24-11.

## System Target File Structure

- “Overview” on page 24-38
- “Header Comments” on page 24-40
- “TLC Configuration Variables” on page 24-41
- “TLC Program Entry Point and Related %includes” on page 24-42
- “RTW\_OPTIONS Section” on page 24-43
- “rtwgensettings Structure” on page 24-44
- “Additional Code Generation Options” on page 24-46
- “Model Reference Considerations” on page 24-46

## Overview

This section is a guide to the structure and contents of an STF. The following listing shows the general structure of an STF. Note that this is not a complete code listing of an STF. The listing consists of excerpts from each of the sections that make up an STF.

```
%%-----  
%% Header Comments Section  
%%-----  
%% SYSTLC: Example Real-Time Target  
%%   TMF: my_target.tmf MAKE: make_rtw EXTMODE: ext_comm  
%% Initial comments contain directives for STF Browser.  
%% Documentation, date, copyright, and other info may follow.  
    ...  
%selectfile NULL_FILE  
    ...  
%%-----  
%% TLC Configuration Variables Section  
%%-----  
%% Assign code format, language, target type.  
%%  
%assign CodeFormat = "Embedded-C"  
%assign TargetType = "RT"  
%assign Language   = "C"  
%%  
%%-----  
%% (OPTIONAL) Import Target Settings  
%%-----  
%include "mytarget_settings.tlc"  
%%  
%%-----  
%% TLC Program Entry Point  
%%-----  
%% Call entry point function.  
%include "codegenentry.tlc"  
%%  
%%-----  
%% (OPTIONAL) Generate Files for Build Process  
%%-----  
%include "mytarget_genfiles.tlc"
```



```

%%-----
%% RTW_OPTIONS Section
%%-----
/%
BEGIN_RTW_OPTIONS
%% Define rtwoptions structure array. This array defines target-specific
%% code generation variables, and controls how they are displayed.
rtwoptions(1).prompt = 'example code generation options';
    ...
rtwoptions(6).prompt = 'Show eliminated blocks';
rtwoptions(6).type = 'Checkbox';
    ...
%-----%
% Configure RTW code generation settings %
%-----%
    ...
%%-----
%% rtwgensettings Structure
%%-----
%% Define suffix string for naming build folder here.
rtwgensettings.BuildDirSuffix = '_mytarget_rtw'
%% Callback compatibility declaration
rtwgensettings.Version = '1';

%% (OPTIONAL) target inheritance declaration
rtwgensettings.DerivedFrom = 'ert.tlc';
%% (OPTIONAL) other rtwGenSettings fields...
    ...
END_RTW_OPTIONS
%/
%%-----
%% targetComponentClass - MATHWORKS INTERNAL USE ONLY
%% REMOVE NEXT SECTION FROM USER_DEFINED CUSTOM TARGETS
%%-----
/%
BEGIN_CONFIGSET_TARGET_COMPONENT
targetComponentClass = 'Simulink.ERTTargetCC';
END_CONFIGSET_TARGET_COMPONENT
%/

```

If you are creating a custom target based on an existing STF, you must remove the `targetComponentClass` section (bounded by the directives `BEGIN_CONFIGSET_TARGET_COMPONENT` and `END_CONFIGSET_TARGET_COMPONENT`). This section is reserved for the use of targets developed internally by MathWorks.

## Header Comments

These lines at the head of the file are formatted as TLC comments. They provide required information to the System Target File Browser and to the build process. Note that you must place the browser comments at the head of the file, before any other comments or TLC statements.

The presence of the comments enables the Simulink Coder software to detect STFs. When the System Target File Browser is opened, the Simulink Coder software scans the MATLAB path for TLC files that have formatted header comments. The comments contain the following directives:

- **SYSTLC**: This string is a descriptor that appears in the browser.
- **TMF**: Name of the template makefile (TMF) to use during build process. When the target is selected, this filename is displayed in the **Template makefile** field of the **Code Generation** pane of the Configuration Parameters dialog box.
- **MAKE**: make command to use during build process. When the target is selected, this command is displayed in the **Make command** field of the **Code Generation** pane of the Configuration Parameters dialog box.
- **EXTMODE**: Name of External mode interface file (if any) associated with your target. If your target does not support External mode, use `no_ext_comm`.

The following header comments are from `matlabroot/rtw/c/ert/ert.tlc`.

```
%% SYSTLC: Embedded Coder TMF: ert_default_tmf MAKE: make_rtw \  
%%   EXTMODE: ext_comm  
%% SYSTLC: Create Visual C/C++ Solution File for the Embedded Coder\  
%%   TMF: RTW.MSVCSBuild MAKE: make_rtw EXTMODE: ext_comm  
.  
.  
.
```

---

**Note** Limitation: Each comment can only contain a maximum of two lines, as shown in the preceding example.

---

Note that you can specify more than one group of directives in the header comments. Each such group is displayed as a different target configuration in the System Target File Browser. In the above example, the first two lines of code specify the default configuration of the ERT target. The next two lines specify a configuration that creates and builds a Microsoft Visual C++ Solution (.shn) file. The figure below shows how these configurations appear in the System Target File Browser.

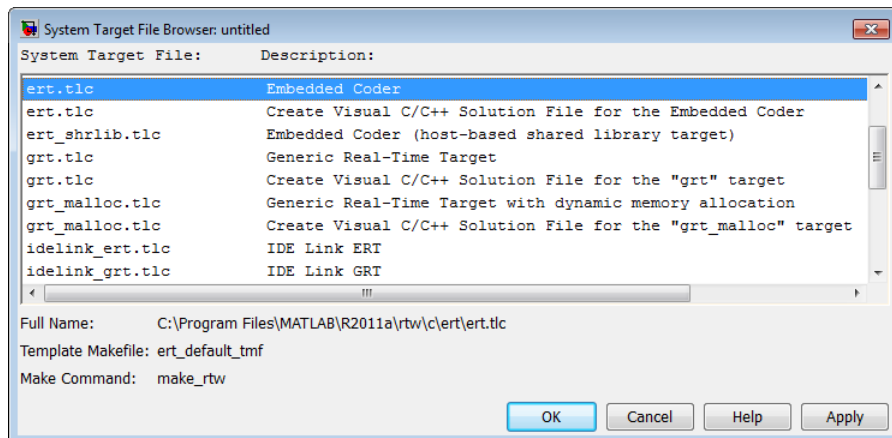

See “Create a Custom Target Configuration” on page 24-61 for an example of customized header comments.

## TLC Configuration Variables

This section of the STF assigns global TLC variables that affect the overall code generation process.

For an embedded target, in almost all cases you should simply use the global TLC variable settings used by the ERT target (ert.tlc). It is especially important that your STF select the Embedded-C code format. Verify that values are assigned to the following variables:

- **CodeFormat:** The `CodeFormat` variable selects one of the available code formats. The `Embedded-C` format is used by the ERT target. Your ERT-based target should specify `Embedded-C` format. `Embedded-C` format is designed for production code, minimal memory usage, static memory allocation, and a simplified interface to generated code.

For information on other code formats, see the “Targets and Code Formats” on page 9-29 chapter of the Simulink Coder documentation.

- **Language:** The only valid value is `C`, which enables support for `C` or `C++` code generation as specified by the configuration parameter `TargetLang` (see the `TargetLang` entry in “Parameter Command-Line Information Summary” in the Simulink Coder documentation for more information).
- **TargetType:** The Simulink Coder software defines the preprocessor symbols `RT` and `NRT` to distinguish simulation code from real-time code. These symbols are used in conditional compilation. The `TargetType` variable determines whether `RT` or `NRT` is defined.

Most targets are intended to generate real-time code. They assign `TargetType` as follows.

```
%assign TargetType = "RT"
```

Some targets, such as the model reference simulation target, accelerated simulation target, `RSim` target, and `S-function` target, generate code for use in nonreal time only. Such targets assign `TargetType` as follows.

```
%assign TargetType = "NRT"
```

### **TLC Program Entry Point and Related %includes**

The code generation process normally begins with `codegenentry.tlc`. The STF invokes `codegenentry.tlc` as follows.

```
%include "codegenentry.tlc"
```

---

**Note** `codegenentry.tlc` and the lower-level TLC files assume that `CodeFormat`, `TargetType`, and `Language` have been assigned. Set these variables before including `codegenentry.tlc`.

---

If you need to implement target-specific code generation features, you should include the TLC files `mytarget_settings.tlc` and `mytarget_genfiles.tlc` in your STF. These files provide a mechanism for executing custom TLC code before and after invoking `codegenentry.tlc`. For information on these mechanisms, see

- “Using `mytarget_settings.tlc`” on page 24-55 for an example of custom TLC code for execution before the main code generation entry point.
- “Using `mytarget_genfiles.tlc`” on page 24-58 for an example of custom TLC code for execution after the main code generation entry point.
- “Target Development and the Build Process” on page 24-29 for general information on the build process, and for information on other build process customization hooks.

Another way to customize the code generation process is to call lower-level functions (normally invoked by `codegenentry.tlc`) directly, and include your own TLC functions at each stage of the process. This approach should be taken with caution. See “TLC Files” for more information.

The lower-level functions called by `codegenentry.tlc` are

- `genmap.tlc`: maps block names to corresponding language-specific block target files.
- `commonsetup.tlc`: sets up global variables.
- `commonentry.tlc`: starts the process of generating code in the format specified by `CodeFormat`.

### **RTW\_OPTIONS Section**

The `RTW_OPTIONS` section is bounded by the directives:

```
/%
    BEGIN_RTW_OPTIONS
    .
    .
    .
    END_RTW_OPTIONS
%/
```

The first part of the `RTW_OPTIONS` section defines an array of `rtwoptions` structures. This structure is discussed in “Using `rtwoptions` to Display Custom Target Options” on page 24-47.

The second part of the `RTW_OPTIONS` section defines `rtwgensettings`, a structure defining the build folder name and other settings for the code generation process. See “`rtwgensettings` Structure” on page 24-44 for information about `rtwgensettings`.

### **rtwgensettings Structure**

The final part of the STF defines the `rtwgensettings` structure. This structure stores information that is written to the `model.rtw` file and used by the build process. The `rtwgensettings` fields of most interest to target developers are

- `rtwgensettings.Version`: Use this property to enable `rtwoptions` callbacks and to use the Callback API in `rtwgensettings.SelectCallback`.

---

**Note** To use callbacks you *must* set:

```
rtwgensettings.Version = '1';
```

---

Add the statement above to the **Configure RTW code generation settings** section of the system target file.

- `rtwgensettings.DerivedFrom`: This string property defines the system target file from which options are to be inherited. See “Inheriting Target Options” on page 24-53.
- `rtwgensettings.SelectCallback`: this property specifies a `SelectCallback` function. You must set `rtwgensettings.Version = '1'`; or your callback will be ignored. `SelectCallback` is associated with the target rather than with any of its individual options. The `SelectCallback` function is triggered when the user selects a target with the System Target File browser.

The `SelectCallback` function is useful for setting up (or disabling) configuration parameters specific to the target.

The following code installs a `SelectCallback` function:

```
rtwgensettings.SelectCallback = 'my_select_callback_handler(hDlg, hSrc)';
```

The arguments to the `SelectCallback` function (`hDlg`, `hSrc`) are handles to private data used by the callback API functions.

---

**Note** If you have developed a custom target and you want it to be compatible with model referencing, you must implement a `SelectCallback` function to declare model reference compatibility. See “Support Model Referencing” on page 24-101.

---

- `rtwgensettings.ActivateCallback`: this property specifies an `ActivateCallback` function. The `ActivateCallback` function is triggered when the active configuration set of the model changes. This could happen during model loading, and also when the user changes the active configuration set.

The following code installs an `ActivateCallback` function:

```
rtwgensettings.ActivateCallback = 'my_activate_callback_handler(hDlg, hSrc)';
```

The arguments to the `ActivateCallback` function (`hDlg`, `hSrc`) are handles to private data used by the callback API functions.

- `rtwgensettings.PostApplyCallback`: this property specifies a `PostApplyCallback` function. The `PostApplyCallback` function is triggered when the user clicks the **Apply** or **OK** button after editing options in the Configuration Parameters dialog box. The `PostApplyCallback` function is called after the changes have been applied to the configuration set.

The following code installs an `PostApplyCallback` function:

```
rtwgensettings.PostApplyCallback = 'my_postapply_callback_handler(hDlg, hSrc)';
```

The arguments to the `PostApplyCallback` function (`hDlg`, `hSrc`) are handles to private data used by the callback API functions.

- `rtwgensettings.BuildDirSuffix`: Most targets define a string that identifies build folders created by the target. The build process appends

the string defined in the `rtwgensettings.BuildDirSuffix` field to the model name to form the name of the build folder. For example, if you define `rtwgensettings.BuildDirSuffix` as follows

```
rtwgensettings.BuildDirSuffix = '_mytarget_rtw'
```

the build folders are named `model_mytarget_rtw`.

### Additional Code Generation Options

“Configure Generated Code with TLC” on page 22-18 in the Simulink Coder documentation describes additional TLC code generation variables. End users of any target can assign these variables by entering statements of the form

```
-aVariable=val
```

in the **TLC options** field of the **Code Generation** pane.

However, the preferred approach is to assign these variables in the STF using statements of the form:

```
%assign Variable = val
```

For readability, we recommend that you add such assignments in the section of the STF after the comment **Configure RTW code generation settings**.

### Model Reference Considerations

See “Support Model Referencing” on page 24-101 for important information on STF and other modifications you may need to make to support the Simulink Coder model referencing features.

### Define and Display Custom Target Options

- “Using `rtwoptions` to Display Custom Target Options” on page 24-47
- “Example System Target File With Customized `rtwoptions`” on page 24-52
- “Inheriting Target Options” on page 24-53



## Using `rtwoptions` to Display Custom Target Options

You control the options to display in the **Code Generation** pane of the Configuration Parameters dialog box by customizing the `rtwoptions` structure in your system target file.

The fields of the `rtwoptions` structure define variables and associated user interface elements to be displayed in the Configuration Parameters dialog box. Using the `rtwoptions` structure array, you can define target-specific options displayed in the dialog box and organize options into categories. You can also write callback functions to specify how these options are processed.

When the **Code Generation** pane opens, the `rtwoptions` structure array is scanned and the listed options are displayed. Each option is represented by an assigned user interface element (check box, edit field, menu, or push button), which displays the current option value.

The user interface elements can be in an enabled or disabled (grayed-out) state. If an option is enabled, the user can change the option value.

You can also use the `rtwoptions` structure array to define special NonUI elements that cause callback functions to be executed, but that are not displayed in the **Code Generation** pane. See “NonUI Elements” on page 24-52 for details.

The elements of the `rtwoptions` structure array are organized into groups. Each group of items begins with a header element of type `Category`. The default field of a `Category` header must contain a count of the remaining elements in the category.

The `Category` header is followed by options to be displayed on the **Code Generation** pane. The header in each category is followed by one or more option definition elements.

Each category of target options corresponds to options listed under **Code Generation** in the Configuration Parameters dialog box.

The table `rtwoptions` Structure Fields Summary on page 24-50 summarizes the fields of the `rtwoptions` structure.

---

**Note** You can save a configuration set with custom options to a MAT-file. However, when you load the MAT-file, some custom options might not appear in the Configuration Parameters dialog box.

---

**Example `rtwoptions` Structure.** The following example is excerpted from `matlabroot/rtw/c/rtwsfcn/rtwsfcn.tlc`, the STF for the S-function target. The code defines an `rtwoptions` structure array of three elements. The default field of the first (header) element is set to 4, indicating the number of elements that follow the header.

```
rtwoptions(1).prompt      = 'S-Function Target';
rtwoptions(1).type        = 'Category';
rtwoptions(1).enable      = 'on';
rtwoptions(1).default     = 4; % number of items under this category
                           % excluding this one.

rtwoptions(1).popupstrings = '';
rtwoptions(1).tlcvariable = '';
rtwoptions(1).tooltip     = '';
rtwoptions(1).callback    = '';
rtwoptions(1).makevariable = '';

rtwoptions(2).prompt      = 'Create new model';
rtwoptions(2).type        = 'Checkbox';
rtwoptions(2).default     = 'on';
rtwoptions(2).tlcvariable = 'CreateModel';
rtwoptions(2).makevariable = 'CREATEMODEL';
rtwoptions(2).tooltip     = ...
    ['Create a new model containing the generated S-Function
     block inside it'];

rtwoptions(3).prompt      = 'Use value for tunable parameters';
rtwoptions(3).type        = 'Checkbox';
rtwoptions(3).default     = 'off';
rtwoptions(3).tlcvariable = 'UseParamValues';
rtwoptions(3).makevariable = 'USEPARAMVALUES';
rtwoptions(3).tooltip     = ...
    ['Use value for variable instead of variable name in generated block mask
     edit fields'];

% Override the default setting for model name prefixing because
% the generated S-function is typically used in multiple models.
rtwoptions(4).default     = 'on';
rtwoptions(4).tlcvariable = 'PrefixModelToSubsysFcnNames';

rtwoptions(5).prompt      = 'Include custom source code';
rtwoptions(5).type        = 'Checkbox';
rtwoptions(5).default     = 'off';
rtwoptions(5).tlcvariable = 'AlwaysIncludeCustomSrc';
rtwoptions(5).tooltip     = ...
    ['Always include provided custom source code in the generated code'];
```

The first element adds the **S-Function Target** pane under **Code Generation** in the Configuration Parameters dialog box. The options defined in `rtwoptions(2)`, `rtwoptions(3)`, and `rtwoptions(5)` display.

If you want to define a large number of options, you can define multiple **Category** groups within a single system target file.

Note the `rtwoptions` structure and callbacks are written in MATLAB code, although they are embedded in a TLC file. To verify the syntax of your `rtwoptions` structure definitions and code, you can execute the commands at the MATLAB prompt by copying and pasting them to the MATLAB Command Window.

For further examples of target-specific `rtwoptions` definitions, see “Example System Target File With Customized `rtwoptions`” on page 24-52.

`rtwoptions` Structure Fields Summary on page 24-50 lists the fields of the `rtwoptions` structure.

**rtwoptions Structure Fields Summary**

Field Name	Description
<code>callback</code>	For examples of callback usage, see “Example System Target File With Customized <code>rtwoptions</code> ” on page 24-52.
<code>closecallback</code> (obsolete)	Do not use <code>closecallback</code> . Use <code>rtwgensettings.PostApplyCallback</code> instead (see “ <code>rtwgensettings</code> Structure” on page 24-44). <code>closecallback</code> is ignored.  For examples of callback usage, see “Example System Target File With Customized <code>rtwoptions</code> ” on page 24-52.
<code>default</code>	Default value of the option (empty if the type is Pushbutton).
<code>enable</code>	Must be 'on' or 'off'. If 'on', the option is displayed as an enabled item; otherwise, as a disabled item.

**rtwoptions Structure Fields Summary (Continued)**

Field Name	Description
makevariable	Template makefile token (if any) associated with the option. The <code>makevariable</code> is expanded during processing of the template makefile. See “Template Makefile Tokens” on page 24-76.
modelReferenceParameterCheck	Specifies whether the option must have the same value in a referenced model and its parent model. If this field is unspecified or has the value 'on' the option values must be same. If the field is specified and has the value 'off' the option values can differ. See “Controlling Configuration Option Value Agreement” on page 24-107.
NonUI	Element that is not displayed, but is used to invoke a close or open callback. See “NonUI Elements” on page 24-52.
opencallback (obsolete)	Do not use <code>opencallback</code> . Use <code>rtwgensettings.SelectCallback</code> instead (see “rtwgensettings Structure” on page 24-44).  For examples of callback usage, see “Example System Target File With Customized <code>rtwoptions</code> ” on page 24-52.
popupstrings	If <code>type</code> is <code>Popup</code> , <code>popupstrings</code> defines the items in the menu. Items are delimited by the " " (vertical bar) character. The following example defines the items of the <b>MAT-file variable name modifier</b> menu used by the GRT target.  'rt_ _rt none'
prompt	Label for the option.
tlcvariable	Name of TLC variable associated with the option.
tooltip	Help string displayed when mouse is over the item.
type	Type of element: <code>Checkbox</code> , <code>Edit</code> , <code>NonUI</code> , <code>Popup</code> , <code>Pushbutton</code> , or <code>Category</code> .

**NonUI Elements.** Elements of the `rtwoptions` array that have type `NonUI` exist solely to invoke callbacks. A `NonUI` element is not displayed in the Configuration Parameters dialog box. You can use a `NonUI` element if you want to execute a callback that is not associated with any user interface element, when the dialog box opens or closes. Only the `opencallback` and `closecallback` fields of a `NonUI` element have significance. See the next section, “Example System Target File With Customized `rtwoptions`” on page 24-52 for an example.

### **Example System Target File With Customized `rtwoptions`**

A working system target file, with MATLAB file callback functions, has been provided as an example of how to use the `rtwoptions` structure to display and process custom options on the **Code Generation** pane. The examples are compatible with the callback API.

The example target files are in the folder:

```
matlabroot/toolbox/rtw/rtwdemos/rtwoptions_demo
```

The example target files include:

- `usertarget.tlc`: The example system target file. This file illustrates how to define custom menus, check boxes, and edit fields. The file also illustrates the use of callbacks.
- `usertargetcallback.m`: A MATLAB file callback invoked by a menu.

Refer to the example files while reading this section. The example system target file, `usertarget.tlc`: illustrates the use of `rtwoptions` to display the following custom target options:

- The **Execution Mode** menu.
- The **Log Execution Time** check box.
- The **Real-Time Interrupt Source** menu. The menu executes a callback defined in an external file, `usertargetcallback.m`. The TLC variable associated with the menu is passed in to the callback, which displays the menu’s current value.
- The edit field **Signal Logging Buffer Size in Doubles**.

Try studying the example code while interacting with the example target options in the Configuration Parameters dialog box. To interact with the example target file,

- 1 Make `matlabroot/toolbox/rtw/rtwdemos/rtwoptions_demo` your working folder.
- 2 Open any model of your choice.
- 3 Open the Configuration Parameters dialog box or Model Explorer and select the **Code Generation** pane.
- 4 Click **Browse**. The System Target File Browser opens. Select `usertarget.tlc`. Then click **OK**.
- 5 Observe that the **Code Generation** pane contains a custom sub-tab: **userPreferred target options (I)**.
- 6 As you interact with the options in this category and open and close the Configuration Parameters dialog box, observe the messages displayed in the MATLAB Command Window. These messages are printed from code in the STF, or from callbacks invoked from the STF.

## Inheriting Target Options

`ert.tlc` provides a basic set of Embedded Coder code generation options. If your target is based on `ert.tlc`, your STF should normally inherit the options defined in ERT.

Use the string property `rtwgensettings.DerivedFrom` in the `rtwgensettings` structure to define the system target file from which options are to be inherited. You should convert your custom target to use this mechanism as follows.

Set the `rtwgensettings.DerivedFrom` property as in the following example:

```
rtwgensettings.DerivedFrom = 'stf.tlc';
```

where `stf` is the name of the system target file from which options are to be inherited. For example:

```
rtwgensettings.DerivedFrom = 'ert.tlc';
```

When the Configuration Parameters dialog box executes this line of code, it includes the options from `stf.tlc` automatically. If `stf.tlc` is a MathWorks internal system target file that has been converted to a new layout, the dialog box displays the inherited options using the new layout.

**Handling Unsupported Options.** If your target does not support all options inherited from `ert.tlc`, you should detect unsupported option settings and display a warning or error message. In some cases, if a user has selected an option your target does not support, you may need to abort the build process. For example, if your target does not support the **Generate an example main program** option, the build process should not be allowed to proceed if that option is selected.

We recommend that you handle these options in `mytarget_settings.tlc`. See the example in “Using `mytarget_settings.tlc`” on page 24-55.

Even though your target may not support all inherited ERT options, it is required that the ERT options are retained in the **Code Generation** pane of the Configuration Parameters dialog box. Do not simply remove unsupported options from the `rtwoptions` structure in the STF. Options must be in the dialog box to be scanned by the Simulink Coder software when it performs optimizations.

For example, you may want to prevent users from turning off the **Single output/update function** option. It may seem reasonable to remove this option from the dialog box and simply assign the TLC variable `CombineOutputUpdateFcns` to `on`. However, if the option is not included in the dialog box, the Simulink Coder software assumes that output and update functions are *not* to be combined. Less efficient code is generated as a result.

## Tips and Techniques for Customizing Your STF

- “Introduction” on page 24-55
- “Required and Recommended `%includes`” on page 24-55
- “Handling Aliases for Target Option Values” on page 24-58
- “Supporting Multiple Development Environments” on page 24-60



## Introduction

The following sections include information on techniques for customizing your STF, including

- How to invoke custom TLC code from your STF
- Approaches to supporting multiple development environments with single or multiple STFs

## Required and Recommended %includes

If you need to implement target-specific code generation features, we recommend that your STF include the TLC files `mytarget_settings.tlc` and `mytarget_genfiles.tlc`.

`mytarget_settings.tlc` provides a mechanism for executing custom TLC code before the main code generation entry point. See “Using `mytarget_settings.tlc`” on page 24-55.

Once your STF has set up any required TLC environment, you must include `codegenentry.tlc` to start the standard code generation process.

`mytarget_genfiles.tlc` provides a mechanism for executing custom TLC code after the main code generation entry point. See “Using `mytarget_genfiles.tlc`” on page 24-58.

**Using `mytarget_settings.tlc`.** This file is optional. Its purpose is to centralize global settings in the code generation environment. Use `mytarget_settings.tlc` to

- Define required TLC paths with `%addincludepath` directives. You may need to do this if you create target-specific TLC function libraries.
- Create records that store target-specific path information and preference settings in the `CompiledModel` general record. This provides a clean mechanism for passing this information into the TLC code generation environment.
- Check user settings for code generation options. If incorrect or unsupported option settings are found, issue an error or warning and consider aborting the build process..

### mytarget\_settings.tlc Example Code

In the TLC code example below, the structure `Settings` is added to the `CompiledModel` record. The `Settings` structure is loaded from the stored target preferences. The `Settings` structure stores target preferences data fields `Implementation` and `ImpPath`.

After `Settings` is added to the `CompiledModel` record, the example code handles inherited options. In this example, the target is assumed to have inherited options from the ERT target. The code examines the settings of inherited ERT code generation options. If the user has selected unsupported options, warning or error messages are displayed. In some cases, selecting an unsupported option causes the build process to terminate.

Conditional code at the end of the function allows display of the `Implementation` and `ImpPath` fields in the MATLAB Command Window.

```
%selectfile NULL_FILE

%% Read user preferences for the target and add to CompiledModel
%assign prefs = FEVAL("RTW.TargetPrefs.load","mytarget.prefs","structure")
%addtorecord CompiledModel Settings prefs

%% Check for unsupported Embedded Coder options and error/warn
%if SuppressErrorStatus == 0
    %assign SuppressErrorStatus = 1
    %assign msg = "Suppressing Error Status as it is not used by this target."
    %warning %<msg>
%endif

%if GenerateSampleERTMain == 1
    %assign msg = "Generating an example main is not supported as the proper main
function is inherently generated. Unselect the \"Generate an example main program\"
checkbox under ERT code generation options."
    %exit %<msg>
%endif

%if GenerateErtSFunction == 1
    %assign msg = "Generating a Simulink S-Function is not supported. Unselect the
\"Create SIL block\" checkbox under ERT code generation options."
    %exit %<msg>
```

```
%endif

%if ExtMode == 1
    %assign msg = "External mode is not currently supported. Unselect the \"External
mode\" checkbox under ERT code generation options."
    %exit %<msg>
%endif

%if MatFileLogging == 1
    %assign msg = "MAT-file logging is not currently supported. Unselect the
\"MAT-file logging\" checkbox under ERT code generation options."
    %exit %<msg>
%endif

%if MultiInstanceERTCode == 1
    %assign msg = "Generate reuseable code is not currently supported. Unselect the
\"Generate reuseable code\" checkbox under ERT code generation options."
    %exit %<msg>
%endif

%if CodeReplacementLibrary == "ISO_C"
    %assign msg = "Code replacement libraries other than ANSI-C are not
currently supported. Select ANSI-C for the \"Code replacement library\" option
under ERT code generation options."
    %exit %<msg>
%endif

%% To display added TLC settings for debugging purposes, set EchoConfigSettings to
1.
%assign EchoConfigSettings = 0
%if EchoConfigSettings
    %selectfile STDOUT
    #####

    IMPLEMENTATION is:
    %<CompiledModel.Settings.Implementation>

    IMPLEMENTATION path is:
    %<CompiledModel.Settings.ImpPath>
%endif
```

```
#####  
%selectfile NULL_FILE  
%endif
```

**Using mytarget\_genfiles.tlc.** mytarget\_genfiles.tlc (optional) is useful as a central file from which to invoke any target-specific TLC files that generate additional files as part of your target build process. For example, your target may create sub-makefiles or project files for a development environment, or command scripts for a debugger to do automatic downloads.

The build process can then invoke these generated files either directly from the make process, or after the executable is created. This is done with the *STF\_make\_rtw\_hook.m* mechanism, as described in “Customize Build Process with STF\_make\_rtw\_hook File” on page 22-21.

The following TLC code shows an example mytarget\_genfiles.tlc file.

```
%selectfile NULL_FILE  
  
%assign ModelName = CompiledModel.Name  
  
%% Create Debugger script  
%assign model_script_file = "%<ModelName>.cfg"  
%assign script_file = "debugger_script_template.tlc"  
  
%if RTWVerbose  
    %selectfile STDOUT  
    ### Creating %<model_script_file>  
    %selectfile NULL_FILE  
%endif  
  
%include "%<script_file>"  
%openfile bld_file = "%<model_script_file>"  
%<CreateDebuggerScript()>  
%closefile bld_file
```

### Handling Aliases for Target Option Values

This section describes utility functions that can be used to detect and resolve alias values or legacy values when testing user-specified values for the

target device type (`ProdHWDeviceType`) and the code replacement library (`CodeReplacementLibrary`).

**RTW.isHWDeviceTypeEq.** To test if two target device type strings represent the same hardware device, invoke the following function:

```
result = RTW.isHWDeviceTypeEq(type1, type2)
```

where *type1* and *type2* are strings containing target device type values or aliases.

The `RTW.isHWDeviceTypeEq` function returns true if *type1* and *type2* are strings representing the same hardware device. For example, the following call returns true:

```
RTW.isHWDeviceTypeEq('Specified', 'Generic->Custom')
```

For a description of the target device type option `ProdHWDeviceType`, see the command-line information for the **Hardware Implementation** pane parameters “Device vendor” and “Device type” in the Simulink reference documentation.

**RTW.resolveHWDeviceType.** To return the device type value for a hardware device, given a value that might be an alias or legacy value, invoke the following function:

```
result = RTW.resolveHWDeviceType(type)
```

where *type* is a string containing a target device type value or alias.

The `RTW.resolveHWDeviceType` function returns the device type value of the device. For example, the following calls both return 'Generic->Custom':

```
RTW.resolveHWDeviceType('Specified')  
RTW.resolveHWDeviceType('Generic->Custom')
```

For a description of the target device type option `ProdHWDeviceType`, see the command-line information for the **Hardware Implementation** pane parameters “Device vendor” and “Device type” in the Simulink reference documentation.

**RTW.isTf1Eq.** To test if two code replacement library (CRL) strings represent the same CRL, invoke the following function:

```
result = RTW.isTf1Eq(name1, name2)
```

where *name1* and *name2* are strings containing CRL values or aliases.

The `RTW.isTf1Eq` function returns true if *name1* and *name2* are strings representing the same CRL. For example, the following call returns true:

```
RTW.isTf1Eq('ANSI_C', 'C89/C90 (ANSI)')
```

For a description of the CRL parameter `CodeReplacementLibrary`, see the command-line information for the **Code Generation > Interface** pane parameter “Code replacement library” in the Simulink Coder reference documentation.

**RTW.resolveTf1Name.** To return the CRL value for a code replacement library, given a value that might be an alias or legacy value, invoke the following function:

```
result = RTW.resolveTf1Name(name)
```

where *name* is a string containing a CRL value or alias.

The `RTW.resolveTf1Name` function returns the CRL value of the referenced CRL. For example, the following calls both return 'C89/C90 (ANSI)':

```
RTW.resolveTf1Name('ANSI_C')  
RTW.resolveTf1Name('C89/C90 (ANSI)')
```

For a description of the CRL parameter `CodeReplacementLibrary`, see the command-line information for the **Code Generation > Interface** pane parameter “Code replacement library” in the Simulink Coder reference documentation.

## Supporting Multiple Development Environments

Your target may require support for multiple development environments (for example, two or more cross-compilers) or multiple modes of code generation (for example, generating a binary executable vs. generating a project file for your compiler).

One approach to this requirement is to implement multiple STFs; each STF invokes a template makefile for the development environment. This amounts to providing two separate targets.

Another approach is to use a single STF that specifies multiple configurations in its comment header. The code within the STF then checks the target preferences to determine which template makefile to invoke. See “mytarget\_default\_tmf.m Example Code” on page 24-89 for an example of how to check target preferences for this information.

One drawback of using a single STF in this way is that the rtoptions need conditional sections if the target options are not the same for all of the configurations the STF supports. The following example (from a hypothetical example target) defines an rtoptions menu element differently, depending on whether or not the MATLAB software is running on a PC (Microsoft Windows platform). This is determined by calling the MATLAB function `ispc`. On the PC, the menu displays a choice of USB or serial ports to be used in communicating with a target device. Otherwise, the menu displays a choice of UNIX<sup>13</sup> logical devices.

```
if ispc
    rtoptions(rtoption_index).default      = 'USB';
    rtoptions(rtoption_index).popupstrings =
'USB|COM1|COM2|COM3|COM4';
else
    rtoptions(rtoption_index).default      = '/dev/ttyS0';
    rtoptions(rtoption_index).popupstrings =
'/dev/ttyS0|/dev/ttyS1|/dev/ttyS2|/dev/ttyS3';
end
```

## Create a Custom Target Configuration

- “Introduction” on page 24-62
- “my\_ert\_target Overview” on page 24-62
- “Creating Target Folders” on page 24-64
- “Create ERT-Based STF” on page 24-65

13. UNIX® is a registered trademark of The Open Group in the United States and other countries.

- “Create ERT-Based TMF” on page 24-71
- “Create Test Model and S-Function” on page 24-71
- “Verify Target Operation” on page 24-73

### Introduction

This tutorial can supplement the example target guides described in “Sample Custom Targets” on page 24-9. For an introduction and example files to examine, try the example targets first.

The purpose of this tutorial is to guide you through the process of creating an ERT-based target, `my_ert_target`. This exercise illustrates several tasks that are usually required when creating a custom target:

- Setting up target folders and modifying the MATLAB path.
- Making modifications to a standard STF and TMF such that the custom target is visible in the System Target File Browser, inherits ERT options, displays target-specific options, and generates code with the default host-based compiler.
- Testing the build process with the custom target, using a simple model that incorporates an inlined S-function.

During this exercise you implement an operational, but skeletal, ERT-based target. This target may be useful as a starting point in a complete implementation of a custom embedded target.

### `my_ert_target` Overview

In the following sections you create a skeletal target, `my_ert_target`. The target inherits and supports the standard options of the ERT target, and displays additional target-specific options in the Configuration Parameters dialog box (see Target-Specific Options for `my_ert_target` on page 24-63).



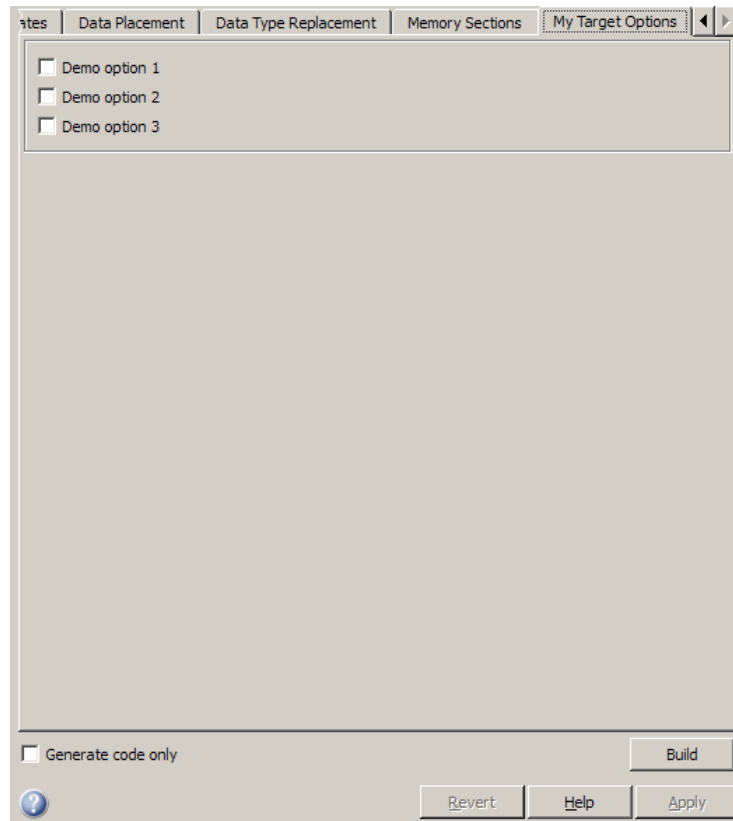

### Target-Specific Options for my\_ert\_target

my\_ert\_target supports a makefile-based build, generating code and executables that run on the host system. my\_ert\_target uses the LCC compiler on a Microsoft Windows platform. This compiler was chosen because it is readily available and is distributed with the Simulink Coder product. If you use a different compiler, you can set up LCC temporarily as your default compiler by typing the MATLAB command

```
mex -setup
```

Follow the prompts and select LCC.

---

**Note** On UNIX<sup>14</sup> systems, verify that you have a C compiler installed. You can then do this exercise, substituting UNIX folder syntax.

---

You can test `my_ert_target` with any model that is compatible with the ERT target. (See “Target” in the Embedded Coder documentation.) Generated programs operate identically to ERT generated programs.

However, to simplify the testing of your target, we recommend testing with `targetmodel`, a very simple fixed-step model (see “Create Test Model and S-Function” on page 24-71). The S-Function block in `targetmodel` uses the source code from the `timestwo` example, and generates fully inlined code. See “S-Function Examples”, “Inlining S-Functions”, and “S-Function Inlining” for further discussion of the `timestwo` example S-function.

## Creating Target Folders

In this section, you create folders to store the target files and add them to the MATLAB path, following the recommended conventions (see “Folder and File Naming Conventions” on page 24-11). You also create a folder to store the test model, S-function, and generated code.

This example assumes that your target and model folders are located within the folder `c:/work`. Note that your target and model folders should not be located anywhere in the MATLAB folder tree (that is, in or under the `matlabroot` folder).

To create the folders and make them accessible,

- 1 Create a target root folder, `my_ert_target`. To do this from the MATLAB Command Window on a Windows platform, enter:

```
cd c:/work
mkdir my_ert_target
```

- 2 Within the target root folder, create a subfolder to store your target files.

---

14. UNIX® is a registered trademark of The Open Group in the United States and other countries.

```
mkdir my_ert_target/my_ert_target
```

- 3 Add these folders to your MATLAB path.

```
addpath c:/work/my_ert_target  
addpath c:/work/my_ert_target/my_ert_target
```

- 4 Create a folder, `my_targetmodel`, to store the test model, S-function, and generated code.

```
mkdir my_targetmodel
```

## Create ERT-Based STF

In this section, you create an STF for your target by copying and modifying the standard STF for the ERT target. Then you validate the STF by viewing the new target in the System Target File Browser and the Configuration Parameters dialog box.

**Editing the STF.** To edit the STF,

- 1 Change your working folder to the folder you created in “Creating Target Folders” on page 24-64.

```
cd c:/work/my_ert_target/my_ert_target
```

- 2 Place a copy of `matlabroot/rtw/c/ert/ert.tlc` in `c:/work/my_ert_target/my_ert_target` and rename it to `my_ert_target.tlc`. The file `ert.tlc` is the STF for the ERT target.
- 3 Open `my_ert_target.tlc` in a text editor of your choice.
- 4 Generally, the first step in customizing an STF is to replace the header comment lines with directives that make your STF visible in the System Target File Browser and define the associated TMF (that you create shortly), `make command`, and `External mode interface file` (if any). See “Header Comments” on page 24-40 for a detailed explanation of these directives.

Replace the header comments in `my_ert_target.tlc` with the following header comments.

```
%% SYSTLC: My ERT-based Target TMF: my_ert_target_lcc.tmf MAKE: make_rtw \
%% EXTMODE: no_ext_comm
```

- 5** The file `my_ert_target.tlc` inherits the standard ERT options, using the mechanism described in “Inheriting Target Options” on page 24-53. Therefore, the existing `rtwoptions` structure definition is superfluous. Edit the `RTW_OPTIONS` section such that it includes only the following code.

```
/%
BEGIN_RTW_OPTIONS

%-----%
% Configure RTW code generation settings %
%-----%

rtwgenSettings.BuildDirSuffix = '_ert_rtw';

END_RTW_OPTIONS
%/
```

- 6** Delete the code after the end of the `RTW_OPTIONS` section, which is delimited by the directives `BEGIN_CONFIGSET_TARGET_COMPONENT` and `END_CONFIGSET_TARGET_COMPONENT`. This code is for use only by internal MathWorks developers.
- 7** Modify the build folder suffix in the `rtwgenSettings` structure in accordance with the conventions described in “`rtwgenSettings` Structure” on page 24-44.

To set the suffix to a string for the `_my_ert_target` custom target, change the line

```
rtwgenSettings.BuildDirSuffix = '_ert_rtw'
```

to

```
rtwgenSettings.BuildDirSuffix = '_my_ert_target_rtw'
```

- 8** Modify the `rtwgenSettings` structure to inherit options from the ERT target and declare Release 14 or later compatibility as described in “`rtwgenSettings` Structure” on page 24-44. Add the following code to the `rtwgenSettings` definition:

```
rtwgensettings.DerivedFrom = 'ert.tlc';
rtwgensettings.Version = '1';
```

- 9 Add an `rtwoptions` structure that defines a target-specific options category with three check boxes just after the `BEGIN_RTW_OPTIONS` directive. The following code shows the complete `RTW_OPTIONS` section, including the `rtwgenSettings` changes made in previous steps.

```
/%
BEGIN_RTW_OPTIONS

rtwoptions(1).prompt      = 'My Target Options';
rtwoptions(1).type        = 'Category';
rtwoptions(1).enable      = 'on';
rtwoptions(1).default     = 3; % number of items under this category
                           % excluding this one.

rtwoptions(1).popupstrings = '';
rtwoptions(1).tlcvariable = '';
rtwoptions(1).tooltip     = '';
rtwoptions(1).callback    = '';
rtwoptions(1).makevariable = '';

rtwoptions(2).prompt      = 'Demo option 1';
rtwoptions(2).type        = 'Checkbox';
rtwoptions(2).default     = 'off';
rtwoptions(2).tlcvariable = 'DummyOpt1';
rtwoptions(2).makevariable = '';
rtwoptions(2).tooltip     = ['Demo option1 (non-functional)'];
rtwoptions(2).callback    = '';

rtwoptions(3).prompt      = 'Demo option 2';
rtwoptions(3).type        = 'Checkbox';
rtwoptions(3).default     = 'off';
rtwoptions(3).tlcvariable = 'DummyOpt2';
rtwoptions(3).makevariable = '';
rtwoptions(3).tooltip     = ['Demo option2 (non-functional)'];
rtwoptions(3).callback    = '';

rtwoptions(4).prompt      = 'Demo option 3';
rtwoptions(4).type        = 'Checkbox';
```

```
rtwoptions(4).default      = 'off';
rtwoptions(4).tlcvariable  = 'DummyOpt3';
rtwoptions(4).makevariable = '';
rtwoptions(4).tooltip      = ['Demo option3 (non-functional)'];
rtwoptions(4).callback     = '';

%-----%
% Configure RTW code generation settings %
%-----%

rtwgensettings.BuildDirSuffix = '_my_ert_target_rtw';
rtwgensettings.DerivedFrom = 'ert.tlc';
rtwgensettings.Version = '1';

END_RTW_OPTIONS
%/
```

**10** Save your changes to `my_ert_target.tlc` and close the file.

**Viewing the STF.** At this point, you can verify that the target inherits and displays ERT options as follows:

- 1** Create a new model.
- 2** Open the Model Explorer or the Configuration Parameters dialog box.
- 3** Select the **Code Generation** pane.
- 4** Click **Browse** to open the System Target File Browser.
- 5** In the Browser, scroll through the list of targets to find the new target, `my_ert_target.tlc`. (This step assumes that your MATLAB path contains `c:/work/my_ert_target/my_ert_target`, as previously set in “Creating Target Folders” on page 24-64.)
- 6** Select My ERT-based Target as shown below, and click **OK**.

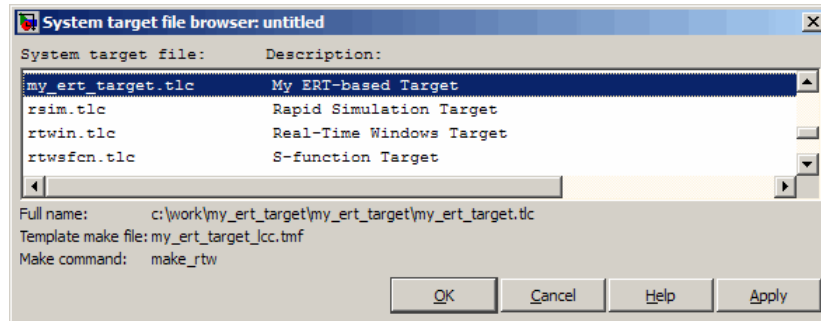

- 7** The **Code Generation** pane now shows that the model is configured for the `my_ert_target.tlc` target. The **System target file**, **Make command**, and **Template makefile** fields should appear as follows:

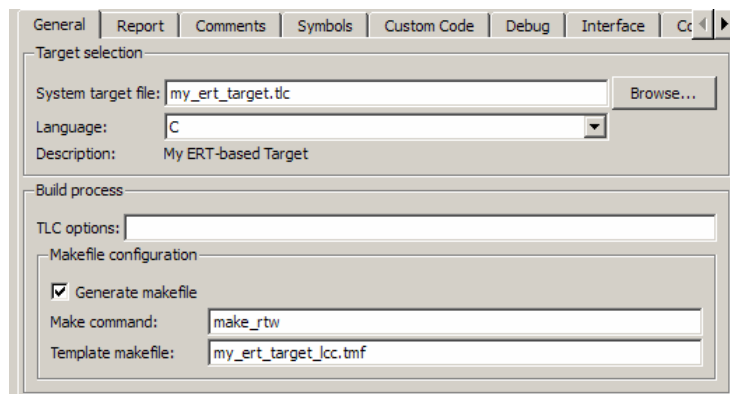

- 8** Select the **My Target Options** pane and observe that the target displays the three check box options defined in the `rtwoptions` structure, as shown in the following figure.

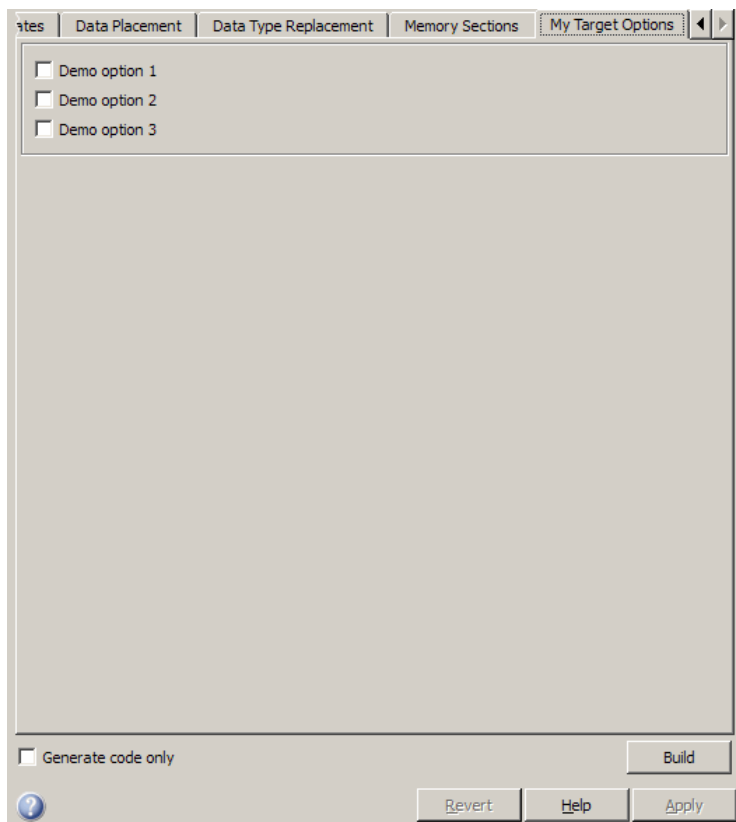

- 9 Select the **Code Generation** pane and reopen the System Target File Browser.
- 10 Select the Embedded Coder target (`ert.tlc`) and observe that the target displays the standard ERT options.
- 11 Close the model. You do not need to save it.

At this point, the STF for the skeletal target is complete. Note, however, that the STF header comments reference a TMF, `my_ert_target_lcc.tmf`. You are not able to invoke the build process for your target until the TMF file is in place. In the next section, you create `my_ert_target_lcc.tmf`.



## Create ERT-Based TMF

In this section, you create a TMF for your target by copying and modifying the standard ERT TMF for the LCC compiler:

- 1 Check that your working folder is still set to the target file folder you created previously in “Creating Target Folders” on page 24-64.

```
c:/work/my_ert_target/my_ert_target
```

- 2 Place a copy of `matlabroot/rtw/c/ert/ert_lcc.tmf` in `c:/work/my_ert_target/my_ert_target` and rename it to `my_ert_target_lcc.tmf`. The file `ert_lcc.tmf` is the ERT compiler-specific template makefile for the LCC compiler.
- 3 Open `my_ert_target_lcc.tmf` in a text editor of your choice.
- 4 Change the `SYS_TARGET_FILE` parameter so that the file reference for your `.tlc` file is generated in the make file. Change the line

```
SYS_TARGET_FILE = any
```

to

```
SYS_TARGET_FILE = my_ert_target.tlc
```

- 5 Save changes to `my_ert_target_lcc.tmf` and close the file.

Your target can now generate code and build a host-based executable. In the next sections, you create a test model and test the build process using `my_ert_target`.

## Create Test Model and S-Function

In this section, you build a simple test model for later use in code generation:

- 1 Set your working folder to `c:/work/my_targetmodel`.

```
cd c:/work/my_targetmodel
```

For the remainder of this tutorial, `my_targetmodel` is assumed to be the working folder. Your target writes the output files of the code generation process into a build folder within the working folder. When inlined code is

generated for the `timestwo` S-function, the build process looks for the TLC implementation of the S-function in the working folder.

- 2 Copy the following C and TLC files for the `timestwo` S-function to your working folder:

- `matlabroot/toolbox/simulink/simdemos/simfeatures/src/timestwo.c`
- `matlabroot/toolbox/simulink/simdemos/simfeatures/tlc_c/timestwo.tlc`

- 3 Build the `timestwo` MEX-file in `c:/work/my_targetmodel`.

```
mex timestwo.c
```

- 4 Create the following model, using an S-Function block from the Simulink User-Defined Functions library. Save the model in your working folder as `targetmodel`.

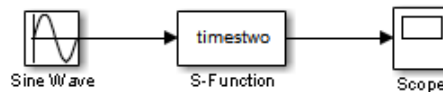

- 5 Double-click the S-Function block to open the Block Parameters dialog box. Enter the S-function name `timestwo`. Click **OK**. The block is now bound to the `timestwo` MEX-file.
- 6 Open Model Explorer or the Configuration Parameters dialog box and select the **Solver** pane.
- 7 Set the solver **Type** to **fixed-step** and click **Apply**.
- 8 Save the model.
- 9 Open the scope and run a simulation. Verify that the `timestwo` S-function multiplies its input by 2.0.

Keep the `targetmodel` model open for use in the next section, in which you generate code using the test model.

## Verify Target Operation

In this section you configure `targetmodel` for the `my_ert_target` custom target, and use the target to generate code and build an executable:

- 1 Open the Configuration Parameters dialog box and select the **Code Generation** pane.
- 2 Click **Browse** to open the System Target File Browser.
- 3 In the Browser, select **My ERT-based Target** and click **OK**.
- 4 The Configuration Parameters dialog box now displays the **Code Generation** pane for `my_ert_target`.
- 5 Select the **Code Generation > Report** pane and select the **Create code generation report** option.
- 6 Click **Apply** and save the model. The model is configured for `my_ert_target`.
- 7 Build the model. If the build succeeds, the MATLAB Command Window displays the message below.

```
### Created executable: ../targetmodel.exe
### Successful completion of build procedure for model:
targetmodel
```

Your working folder contains the `targetmodel.exe` file and the build folder, `targetmodel_my_ert_target_rtw`, which contains generated code and other files. The working folder also contains an `slprj` folder, used internally by the build process.

The code generator also creates and displays a code generation report.

- 8 To view the generated model code, go to the code generation report window. In the **Contents** pane, click the `targetmodel.c` link.

- 9 In `targetmodel.c`, locate the model step function, `targetmodel_step`. Observe the following code.

```
/* S-Function Block: <Root>/S-Function */  
/* Multiply input by two */  
targetmodel_B.SFunction = targetmodel_B.SineWave * 2.0;
```

The presence of this code confirms that the `my_ert_target` custom target has generated an inlined output computation for the S-Function block in the model.

## Customize Template Makefiles

### In this section...

“Template Makefiles and Tokens” on page 24-75

“Invoke the make Utility” on page 24-82

“Structure of the Template Makefile” on page 24-83

“Customize and Create Template Makefiles” on page 24-87

## Template Makefiles and Tokens

- “Prerequisites” on page 24-75
- “Template Makefile Role In Makefile Creation” on page 24-75
- “Template Makefile Tokens” on page 24-76

### Prerequisites

To configure or customize a template makefile (TMF), you should be familiar with how the `make` command works and how it processes makefiles. You should also understand makefile build rules. For information on these topics, refer to the documentation provided with the `make` utility you use.

### Template Makefile Role In Makefile Creation

TMFs are made up of statements containing tokens. The Simulink Coder build process expands tokens and creates a makefile, `model.mk`. TMFs are designed to generate makefiles for specific compilers on specific platforms. The generated `model.mk` file is tailored to compile and link code generated from your model, using commands specific to your development system.



**Creation of model.mk**

## Template Makefile Tokens

The `make_rtw` command (or a different command provided with some targets) directs the process of generating `model.mk`. The `make_rtw` command processes the TMF specified on the **Code Generation** pane of the Configuration Parameters dialog box. `make_rtw` copies the TMF, line by line, expanding each token encountered. Template Makefile Tokens Expanded by `make_rtw` on page 24-76 lists the tokens and their expansions.

These tokens are used in several ways by the expanded makefile:

- To control the conditional behavior in the makefile. The conditionals are used to control the source file lists, library names, target to be built, and other build-related information.
- To provide the macro definitions for compiling the files, for example, `-DINTEGER_CODE=1`.

### Template Makefile Tokens Expanded by `make_rtw`

Token	Expansion
<b>General purpose</b>	
>ALT_MATLAB_BIN<	Alternate full pathname for the MATLAB executable; value is different than value for MATLAB_BIN token when the full pathname contains spaces.
>ALT_MATLAB_ROOT<	Alternate full pathname for the MATLAB installation; value is different than value for MATLAB_ROOT token when the full pathname contains spaces.
>BUILDDARGS<	Options passed to <code>make_rtw</code> . This token is provided so that the contents of your <code>model.mk</code> file changes when you change the build arguments, thus forcing an update of all modules when your build options change.
>COMBINE_OUTPUT_UPDATE_FCNS<	True (1) when <b>Single output/update function</b> is selected, otherwise False (0). Used for the macro definition <code>-DONESTEPFCN=1</code> .

**Template Makefile Tokens Expanded by make\_rtw (Continued)**

<b>Token</b>	<b>Expansion</b>
>COMPUTER<	Computer type. See the MATLAB computer command.
>EXPAND_LIBRARY_LOCATION<	Location of precompiled library file. The <code>TargetPreCompLibLocation</code> configuration parameter can override this setting. For examples, see “Control Library Location and Naming During Build” on page 22-7.
>EXPAND_LIBRARY_NAME<	Library name. For examples, see “Control Library Location and Naming During Build” on page 22-7 and “Modify the Template Makefile” on page 14-127.
>EXPAND_LIBRARY_SUFFIX<	Library suffix. The <code>TargetLibSuffix</code> configuration parameter can override this setting. For examples, see “Control Library Location and Naming During Build” on page 22-7.
>EXT_MODE<	True (1) to enable generation of External mode support code, otherwise False (0).
>EXTMODE_TRANSPORT<	Index of transport mechanism (for example, <code>tcpip</code> , <code>serial</code> ) for External mode.
>EXTMODE_STATIC<	True (1) if static memory allocation is selected for External mode. False (0) if dynamic memory allocation is selected.
>EXTMODE_STATIC_SIZE<	Size of static memory allocation buffer (if any) for External mode.
>GENERATE_ERT_S_FUNCTION<	True (1) when <b>Create SIL block</b> is selected, otherwise False (0). Used for control of the makefile target of the build.
>INCLUDE_MDL_TERMINATE_FCN<	True (1) when <b>Terminate function required</b> is selected, otherwise False (0). Used for the macro definition <code>-DTERMFCN==1</code> .

### Template Makefile Tokens Expanded by make\_rtw (Continued)

Token	Expansion
>INTEGER_CODE<	True (1) when <b>Support floating-point numbers</b> is not selected, otherwise False (0). INTEGER_CODE is a required macro definition when compiling the source code and is used when selecting precompiled libraries to link against.
>MAKEFILE_NAME<	<i>model.mk</i> — The name of the makefile that was created from the TMF.
>MAT_FILE<	True (1) when <b>MAT-file logging</b> is selected, otherwise False (0). MAT_FILE is a required macro definition when compiling the source code and also is used to include logging code in the build process.
>MATLAB_BIN<	Location of the MATLAB executable.
>MATLAB_ROOT<	Path to where MATLAB is installed.
>MEM_ALLOC<	Either RT_MALLOC or RT_STATIC. Indicates how memory is to be allocated.
>MEXEXT<	MEX-file extension. See the MATLAB mexext command.
>MODEL_MODULES<	Any additional generated source modules. For example, you can split a large model into two files, <i>model.c</i> and <i>model1.c</i> . In this case, this token expands to <i>model1.c</i> .
>MODEL_MODULES_OBJ<	Object filenames (.obj) corresponding to any additional generated source modules.
>MODEL_NAME<	Name of the Simulink block diagram currently being built.
>MULTITASKING<	True (1) if solver mode is multitasking, otherwise False (0).
>NCSTATES<	Number of continuous states.
>NUMST<	Number of sample times in the model.



**Template Makefile Tokens Expanded by make\_rtw (Continued)**

<b>Token</b>	<b>Expansion</b>
>PORTABLE_WORDSIZES<	True (1) when <b>Enable portable word sizes</b> is selected, otherwise False (0).
>RELEASE_VERSION<	The MATLAB release version.
>S_FUNCTIONS<	List of noninlined S-function sources.
>S_FUNCTIONS_LIB<	List of S-function libraries available for linking.
>S_FUNCTIONS_OBJ<	Object (.obj) file list corresponding to noninlined S-function sources.
>SOLVER<	Solver source filename, for example, ode3.c.
>SOLVER_OBJ<	Solver object (.obj) filename, for example, ode3.obj.
>TARGET_LANG_EXT<	c when the Simulink Coder <b>Language</b> selection is C, <b>cpp</b> when the <b>Language</b> selection is C++. Used in the makefile to control the extension on generated source files.
>TGT_FCN_LIB<	Specifies compiler command line options. The line in the makefile is TGT_FCN_LIB =  >TGT_FCN_LIB< . By default, the Simulink Coder build process expands the  >TGT_FCN_LIB<  token to match the setting of the <b>Code replacement library</b> parameter on the <b>Code Generation &gt; Interface</b> pane of the Configuration Parameters dialog box. Possible values for this option include <b>ANSI_C</b> , <b>C99 (ISO)</b> , <b>GNU99 (GNU)</b> , and <b>C++ (ISO)</b> . You can use this token in a makefile conditional statement to specify compiler options to be used. For example, if you set the token to <b>C99 (ISO)</b> , the compiler might need an additional option set to support C99 library functions.
>TID01EQ<	True (1) if sampling rates of the continuous task and the first discrete task are equal, otherwise False (0).

**Template Makefile Tokens Expanded by make\_rtw (Continued)**

Token	Expansion
<b>S-function and build information support</b>	
<b>Note</b> For examples of the tokens in this section, see “Modify the Template Makefile” on page 14-127.	
>START_EXPAND_INCLUDES<   >EXPAND_DIR_NAME<   >END_EXPAND_INCLUDES<	List of folder names to add to the include path. Additionally, the ADD_INCLUDES macro must be added to the INCLUDES line.
>START_EXPAND_LIBRARIES<   >EXPAND_LIBRARY_NAME<   >END_EXPAND_LIBRARIES<	List of library names.
>START_EXPAND_MODULES<   >EXPAND_MODULE_NAME<   >END_EXPAND_MODULES<	Library module names within  >START_EXPAND_LIBRARIES<  and  >START_PRECOMP_LIBRARIES<  library lists.
>START_EXPAND_RULES<   >EXPAND_DIR_NAME<   >END_EXPAND_RULES<	Makefile rules.
>START_PRECOMP_LIBRARIES<   >EXPAND_LIBRARY_NAME<   >END_PRECOMP_LIBRARIES<	List of precompiled library names.
<b>Model reference support</b>	
<b>Note</b> For examples of the tokens in this section, see “Providing Model Referencing Support in the TMF” on page 24-104.	
>MASTER_ANCHOR_DIR<	For parallel builds, current work folder (pwd) at the time the build started.
>MODELLIB<	Name of the library file generated for the current model.
>MODELREFS<	List of models referenced by the top model.

**Template Makefile Tokens Expanded by make\_rtw (Continued)**

Token	Expansion
>MODELREF_LINK_LIBS<	List of referenced model libraries against which the top model links.
>MODELREF_LINK_RSPFILE_NAME<	Name of a response file against which the top model links. This token is valid only for build environments that support linker response files. For an example of its use, see <i>matlabroot/rtw/c/grt/grt_vc.tmf</i> .
>MODELREF_TARGET_TYPE<	Type of target being built. Possible values are <ul style="list-style-type: none"> <li>• NONE: Standalone model or top model referencing other models</li> <li>• RTW: Model reference Simulink Coder target build</li> <li>• SIM: Model reference simulation target build</li> </ul>
>RELATIVE_PATH_TO_ANCHOR<	Relative path, from the location of the generated makefile, to the MATLAB working folder.
>START_DIR<	Current work folder (pwd) at the time the build started. This token is required for parallel builds.
>START_MDLREFINC_EXPAND_INCLUDES<   >MODELREF_INC_PATH<   >END_MDLREFINC_EXPAND_INCLUDES<	List of include paths for models referenced by the top model.
>SHARED_BIN_DIR<	Folder for the library file built from the shared source files.
>SHARED_LIB<	Library file built from the shared source files, including the path to the library folder.
>SHARED_SRC<	Shared source files specification, including the path to the shared utilities folder.
>SHARED_SRC_DIR<	Folder for shared source files.

These tokens are expanded by substitution of parameter values known to the build process. For example, if the source model contains blocks with two different sample times, the TMF statement

```
NUMST = |>NUMST<|
```

expands to the following in *model.mk*.

```
NUMST = 2
```

In addition to the above, `make_rtw` expands tokens from other sources:

- Target-specific tokens defined in the target options of the Configuration Parameters dialog box
- Structures in the `rtwoptions` section of the system target file. Any structures in the `rtwoptions` structure array that contain the field `makevariable` are expanded.

The following example is extracted from *matlabroot/rtw/c/grt/grt.tlc*. The section starting with `BEGIN_RTW_OPTIONS` contains MATLAB code that sets up `rtwoptions`. The following directive causes the `|>EXT_MODE<|` token to be expanded to 1 (on) or 0 (off), depending on how you set the External mode options.

```
rtwoptions(2).makevariable = 'EXT_MODE'
```

## Invoke the make Utility

- “make Command” on page 24-82
- “make Utility Versions” on page 24-83

### make Command

After creating *model.mk* from your TMF, the Simulink Coder build process invokes a `make` command. To invoke `make`, the build process issues this command.

```
makecommand -f model.mk
```

*makecommand* is defined by the `MAKECMD` macro in your target’s TMF (see “Structure of the Template Makefile” on page 24-83). You can specify additional options to `make` in the **Make command** field of the **Code Generation** pane. (See the sections “Specify a Make Command” on page 15-13 and “Template Makefiles and Make Options” on page 9-38 in the Simulink Coder documentation.)

For example, specifying `OPT_OPTS=-O2` in the **Make command** field causes `make_rtw` to generate the following make command.

```
makecommand -f model.mk OPT_OPTS=-O2
```

A comment at the top of the TMF specifies the available make command options. If these options do not provide you with enough flexibility, you can configure your own TMF.

### make Utility Versions

The make utility lets you control nearly every aspect of building your real-time program. There are several different versions of make available. The Simulink Coder software provides the Free Software Foundation GNU make for both UNIX<sup>15</sup> and PC platforms in platform-specific subfolders under

```
matlabroot/bin
```

It is possible to use other versions of make with the Simulink Coder software, although GNU Make is recommended. To be compatible with the Simulink Coder software, verify that your version of make supports the following command format.

```
makecommand -f model.mk
```

### Structure of the Template Makefile

A TMF has multiple sections, including the following:

- **Abstract** — Describes what the makefile targets. Here is a representative abstract from the GRT TMFs in `matlabroot/rtw/c/grt`:

```
# File      : grt_lcc.tmf
#
# Abstract:
#      Template makefile for building a PC-based stand-alone generic real-time
#      version of Simulink model using generated C code and LCC compiler
#      Version 2.4.
#
```

---

15. UNIX<sup>®</sup> is a registered trademark of The Open Group in the United States and other countries.

```

# This makefile attempts to conform to the guidelines specified in the
# IEEE Std 1003.2-1992 (POSIX) standard. It is designed to be used
# with GNU Make (gmake) which is located in matlabroot/bin/win32.
#
# Note that this template is automatically customized by the build
# procedure to create "<model>.mk"
#
# The following defines can be used to modify the behavior of the
# build:
#     OPT_OPTS      - Optimization options. Default is none. To enable
#                   debugging specify as OPT_OPTS=-g4.
#     OPTS          - User specific compile options.
#     USER_SRCS    - Additional user sources, such as files needed by
#                   S-functions.
#     USER_INCLUDES - Additional include paths
#                   (i.e. USER_INCLUDES="-Iwhere-ever -Iwhere-ever2")
#                   (For Lcc, have a '/' as file separator before the
#                   file name instead of a '\' .
#                   i.e., d:\work\proj1\myfile.c - reqd for 'gmake')
#
# This template makefile is designed to be used with a system target
# file that contains 'rtwgensettings.BuildDirSuffix'. See grt.tlc.

```

- Macros read by make\_rtw section — Defines macros that tell make\_rtw how to process the TMF. Here is a representative Macros read by make\_rtw section from the GRT TMFs in *matlabroot/rtw/c/grt*:

```

#----- Macros read by make_rtw -----
#
# The following macros are read by the build procedure:
#
# MAKECMD      - This is the command used to invoke the make utility
# HOST         - What platform this template makefile is targeted for
#               (i.e. PC or UNIX)
# BUILD        - Invoke make from the build procedure (yes/no)?
# SYS_TARGET_FILE - Name of system target file.

MAKECMD      = "%MATLAB%\bin\win32\gmake"
SHELL        = cmd
HOST         = PC

```

```
BUILD          = yes
SYS_TARGET_FILE = grt.tlc
BUILD_SUCCESS  = *** Created
COMPILER_TOOL_CHAIN = lcc
```

```
MAKEFILE_FILESEP = /
```

The macros in this section might include:

- **MAKECMD** — Specifies the command used to invoke the make utility. For example, if `MAKECMD = mymake`, then the make command invoked is
 

```
mymake -f model.mk
```
- **HOST** — Specifies the platform targeted by this TMF. This can be `PC`, `UNIX`, *computer\_name* (see the MATLAB computer command), or `ANY`.
- **BUILD** — Instructs `make_rtw` whether or not it should invoke make from the Simulink Coder build procedure. Specify `yes` or `no`.
- **SYS\_TARGET\_FILE** — Specifies the name of the system target file or the value `any`. This is used for consistency checking by `make_rtw` to verify the system target file specified in the **Target selection** panel of the **Code Generation** pane of the Configuration Parameters dialog box. If you specify `any`, you can use the TMF with any system target file.
- **BUILD\_SUCCESS** — Optional macro that specifies the build success string to be displayed for make completion on the PC. For example,
 

```
BUILD_SUCCESS = ### Successful creation of
```

The `BUILD_SUCCESS` macro, if used, replaces the standard build success string found in the TMFs distributed with the bundled Simulink Coder targets (such as GRT):

```
@echo ### Created executable $(MODEL).exe
```

Your TMF must include either the standard build success string, or use the `BUILD_SUCCESS` macro. For an example of the use of `BUILD_SUCCESS`, see `matlabroot/rtw/c/grt/grt_lcc.tmf` or the code example above this list of macros.

- **BUILD\_ERROR** — Optional macro that specifies the build error message to be displayed when an error is encountered during the make procedure. For example,

```
BUILD_ERROR = ['Error while building ', modelName]
```

- `VERBOSE_BUILD_OFF_TREATMENT = PRINT_OUTPUT_ALWAYS` — Optional macro to include if you want the makefile output to be displayed always (regardless of the setting of the **Verbose build** option in the **Code Generation > Debug** pane).
- `COMPILER_TOOL_CHAIN` — For builds on Windows systems, specifies which compiler setup file (located in `matlabroot/toolbox/rtw/rtw`) to use:
  - `lcc` selects `setup_for_lcc.m`
  - `vc` selects `setup_for_visual.m`
  - `vcx64` selects `setup_for_visual_x64.m`
  - `watc` selects `setup_for_watcom.m`
  - `default` selects `setup_for_default.m`

For builds on UNIX systems, specify `unix`.

Any other value is flagged as unknown and `make_rtw` uses `setup_for_default.m`.

- `DOWNLOAD` — An optional macro that you can specify as yes or no. If specified as yes (and `BUILD=yes`), then `make` is invoked a second time with the download target.

```
make -f model.mk download
```

- `DOWNLOAD_SUCCESS` — An optional macro that you can use to specify the download success string to be used when looking for a completed download. For example,

```
DOWNLOAD_SUCCESS = ### Downloaded
```

- `DOWNLOAD_ERROR` — An optional macro that you can use to specify the download error message to be displayed when an error is encountered during the download. For example,

```
DOWNLOAD_ERROR = ['Error while downloading ', modelName]
```

- Tokens expanded by `make_rtw` section — Defines the tokens that `make_rtw` expands. Here is a brief excerpt from a representative



Tokens expanded by `make_rtw` section from the GRT TMFs in `matlabroot/rtw/c/grt`:

```
#----- Tokens expanded by make_rtw -----
#
# The following tokens, when wrapped with "|>" and "<|" are expanded by the
# build procedure.
#
# MODEL_NAME           - Name of the Simulink block diagram
# MODEL_MODULES        - Any additional generated source modules
# MAKEFILE_NAME        - Name of makefile created from template makefile <model>.mk
# MATLAB_ROOT          - Path to where MATLAB is installed.
...

MODEL                  = |>MODEL_NAME<|
MODULES                = |>MODEL_MODULES<|
MAKEFILE               = |>MAKEFILE_NAME<|
MATLAB_ROOT            = |>MATLAB_ROOT<|
...
```

For more information about TMF tokens, see [Template Makefile Tokens Expanded by `make\_rtw`](#) on page 24-76.

- Subsequent sections vary based on compiler, host, and target. Some common sections include `Model` and `reference models`, `External mode`, `Tool Specifications` or `Tool Definitions`, `Include Path`, `C Flags`, `Additional Libraries`, and `Source Files`.
- `Rules` section — Contains the make rules used in building an executable from the generated source code. The build rules are typically specific to your version of make. The `Rules` section might be followed by related sections such as `Dependencies`.

## Customize and Create Template Makefiles

- “Introduction” on page 24-88
- “Setting Up a Template Makefile” on page 24-88
- “Using Macros and Pattern Matching Expressions in a Template Makefile” on page 24-90

- “Using the `rtwmakecfg.m` API to Customize Generated Makefiles” on page 24-92
- “Supporting Continuous Time in Custom Targets” on page 24-98
- “Model Reference Considerations” on page 24-99
- “Generating Make Commands for Nondefault Compilers” on page 24-99

### Introduction

This section describes the mechanics of setting up a custom template makefile (TMF) and incorporating it into the build process. It also discusses techniques for modifying a TMF and MATLAB file mechanisms associated with the TMF.

Before creating a custom TMF, you should read “Folder and File Naming Conventions” on page 24-11 to understand the folder structure and MATLAB path requirements for custom targets.

### Setting Up a Template Makefile

To customize or create a new TMF, you should copy an existing GRT or ERT TMF from one of the following locations:

```
matlabroot/rtw/c/grt  
matlabroot/rtw/c/ert
```

Place the copy in the same folder as the associated system target file (STF). Usually, this is the `mytarget/mytarget` folder within the target folder structure. Then, rename your TMF (for example, `mytarget.tmf`) and modify it.

To allow the build process to locate and select your TMF, you must provide information in the STF file header (see “System Target File Structure” on page 24-37). For a target that implements a single TMF, the standard way to specify the TMF to be used in the build process is to use the TMF directive of the STF file header.

```
TMF: mytarget.tmf
```

If your target must support multiple development environments, you can specify a MATLABfile script that selects the TMF, based on user preferences. To do this, you must

- Create the script in your `mytarget/mytarget` folder. The naming convention for this file is `mytarget_default_tmf.m`.
- Specify this file in the TMF directive of the STF file header.

```
TMF: mytarget_default_tmf
```

The build process then invokes your `mytarget_default_tmf.m` file, which then selects the TMF, based on target preference settings. “`mytarget_default_tmf.m` Example Code” on page 24-89 illustrates this technique.

Another useful technique is to store a path to the user’s installed development environment in your target preferences. You can then locate the template makefiles under the tool folder. This allows several tool-specific template makefiles files to be located under the specific tool folder.

**mytarget\_default\_tmf.m Example Code.** The code example below implements a function, `mytarget_default_tmf`. The function loads target preferences into a structure from preferences data stored on disk. The code verifies that the target preferences information is consistent with the STF name, and extracts the associated TMF name. The TMF name is returned as the string `tmf`.

```
function [tmf,envVal] = mytarget_default_tmf
    try
        prefs = RTW.TargetPrefs.load('mytarget.prefs','structure');
    catch exception
        rethrow(exception);
    end

    % Get the desired MYTARGET implementation and check that it is supported
    if ~isfield(prefs, 'Implementation')
        error('MYTARGET preferences not set correctly, update Target Preferences.');
```

```
    end
    imp = deblank(lower(prefs.Implementation));
    stfname = deblank(lower(get_param(bdroot, 'RTWSystemTargetFile')));

    if ~strncmp(imp, stfname, length(stfname) - length('.t1c'))
        msg = ['System Target filename: ', stfname,
              ' does not match Implementation specified in Target Preferences: ', imp];
        error(msg);
    end
end
```

```
end

% Return the desired template make file.
tmf = [imp, '.tmf'];

% This argument is unused
envVal = '';
```

## Using Macros and Pattern Matching Expressions in a Template Makefile

This section shows, through an example, how to use macros and file-pattern-matching expressions in a TMF to generate commands in the *model.mk* file.

The make utility processes the *model.mk* makefile and generates a set of commands based upon dependency rules defined in *model.mk*. After make generates the set of commands for building or rebuilding *test*, make executes them.

For example, to build a program called *test*, make must link the object files. However, if the object files don't exist or are out of date, make must compile the source code. Thus there is a dependency between source and object files.

Each version of make differs slightly in its features and how rules are defined. For example, consider a program called *test* that gets created from two sources, *file1.c* and *file2.c*. Using most versions of make, the dependency rules would be

```
test: file1.o file2.o
    cc -o test file1.o file2.o

file1.o: file1.c
    cc -c file1.c

file2.o: file2.c
    cc -c file2.c
```

In this example, a UNIX<sup>16</sup> environment is assumed. In a PC environment the file extensions and compile and link commands are different.

In processing the first rule

```
test: file1.o file2.o
```

make sees that to build `test`, it needs to build `file1.o` and `file2.o`. To build `file1.o`, make processes the rule

```
file1.o: file1.c
```

If `file1.o` doesn't exist, or if `file1.o` is older than `file1.c`, make compiles `file1.c`.

The format of Simulink Coder TMFs follows the above example. Our TMFs use additional features of `make` such as macros and file-pattern-matching expressions. In most versions of `make`, a macro is defined with

```
MACRO_NAME = value
```

References to macros are made with `$(MACRO_NAME)`. When `make` sees this form of expression, it substitutes *value* for `$(MACRO_NAME)`.

You can use pattern matching expressions to make the dependency rules more general. For example, using GNU<sup>17</sup> Make, you could replace the two “`file1.o: file1.c`” and “`file2.o: file2.c`” rules with the single rule

```
%.o : %.c
      cc -c $<
```

Note that `$<` in the previous example is a special macro that equates to the dependency file (that is, `file1.c` or `file2.c`). Thus, using macros and the “%” pattern matching character, the previous example can be reduced to

```
SRCS = file1.c file2.c
OBJS = $(SRCS:.c=.o)
```

16. UNIX<sup>®</sup> is a registered trademark of The Open Group in the United States and other countries.

17. GNU<sup>®</sup> is a registered trademark of the Free Software Foundation.

```
test: $(OBJS)
    cc -o $@ $(OBJS)

%.o : %.c
    cc -c $<
```

Note that the `$@` macro above is another special macro that equates to the name of the current dependency target, in this case `test`.

This example generates the list of objects (OBJS) from the list of sources (SRCS) by using the string substitution feature for macro expansion. It replaces the source file extension (for example, `.c`) with the object file extension (`.o`). This example also generalized the build rule for the program, `test`, to use the special `"$@"` macro.

## Using the `rtwmakecfg.m` API to Customize Generated Makefiles

- “Overview” on page 24-92
- “Creating the `rtwmakecfg.m` Function” on page 24-93
- “Modifying the Template Makefile” on page 24-96

**Overview.** Simulink Coder TMFs provide tokens that let you add the following items to generated makefiles:

- Source folders
- Include folders
- Run-time library names
- Run-time module objects

S-functions can add this information to the makefile by using an `rtwmakecfg.m` file function. This function is particularly useful when building a model that contains one or more of your S-Function blocks, such as device driver blocks.

To add information pertaining to an S-function to the makefile,

- 1 Create the function `rtwmakecfg` in a file `rtwmakecfg.m`. The Simulink Coder software associates this file with your S-function based on its folder location. “Creating the `rtwmakecfg.m` Function” on page 24-93 discusses the requirements for the `rtwmakecfg` function and the data it should return.
- 2 Modify your target’s TMF such that it supports macro expansion for the information returned by `rtwmakecfg` functions. “Modifying the Template Makefile” on page 24-96 discusses the required modifications.

After the TLC phase of the build process, when generating a makefile from the TMF, the Simulink Coder build process searches for an `rtwmakecfg.m` file in the folder that contains the S-function component. If it finds the file, the build process calls the `rtwmakecfg` function.

**Creating the `rtwmakecfg.m` Function.** Create the `rtwmakecfg.m` file in the same folder as your S-function component (a MEX-file with a platform-dependent extension, such as `.mexw32` on 32-bit Microsoft Windows platforms). The function must return a structured array that contains the following fields:

Field	Description
<code>makeInfo.includePath</code>	A cell array that specifies additional include folder names, organized as a row vector. The Simulink Coder build process expands the folder names into include instructions in the generated makefile.
<code>makeInfo.sourcePath</code>	A cell array that specifies additional source folder names, organized as a row vector. The Simulink Coder build process expands the folder names into make rules in the generated makefile.
<code>makeInfo.sources</code>	A cell array that specifies additional source filenames (C or C++), organized as a row vector. The Simulink Coder build process expands the filenames into make variables that contain the source files. You should specify only filenames (with extension). Specify path information with the <code>sourcePath</code> field.

Field	Description
makeInfo.linkLibsObjs	A cell array that specifies additional, fully qualified paths to object or library files against which Simulink Coder generated code should link. The Simulink Coder build process does not compile the specified objects and libraries. However, it includes them when linking the final executable. This can be useful for incorporating libraries that you do not want the Simulink Coder build process to recompile or for which the source files are not available. You might also use this element to incorporate source files from languages other than C and C++. This is possible if you first create a C compatible object file or library outside of the Simulink Coder build process.
makeInfo.precompile	A Boolean flag that indicates whether the libraries specified in the <code>rtwmakecfg.m</code> file exist in a specified location ( <code>precompile==1</code> ) or if the libraries need to be created in the build folder during the Simulink Coder build process ( <code>precompile==0</code> ).
makeInfo.library	A structure array that specifies additional run-time libraries and module objects, organized as a row vector. The Simulink Coder build process expands the information into make rules in the generated makefile. See the next table for a list of the library fields.



The `makeInfo.library` field consists of the following elements:

Element	Description
<code>makeInfo.library(n).Name</code>	A character array that specifies the name of the library (without an extension).
<code>makeInfo.library(n).Location</code>	A character array that specifies the folder in which the library is located when precompiled. See the description of <code>makeInfo.precompile</code> in the preceding table for more information. A target can use the <code>TargetPreCompLibLocation</code> parameter to override this value. See “Specify the Location of Precompiled Libraries” on page 22-8 in the Simulink Coder documentation for details.
<code>makeInfo.library(n).Modules</code>	A cell array that specifies the C or C++ source file base names (without an extension) that comprise the library. Do not include the file extension. The makefile appends the object extension.

**Note** The `makeInfo.library` field must fully specify each library and how to build it. The modules list in the `makeInfo.library(n).Modules` element cannot be empty. If you need to specify a link-only library, use the `makeInfo.linkLibsObjs` field instead.

### Example:

```
disp(['Running rtwmakecfg from folder: ',pwd]);
makeInfo.includePath = { fullfile(pwd, 'somedir2') };
makeInfo.sourcePath = {fullfile(pwd, 'somedir2'), fullfile(pwd, 'somedir3')};
makeInfo.sources = { 'src1.c', 'src2.cpp'};
makeInfo.linkLibsObjs = { fullfile(pwd, 'somedir3', 'src3.object'),...
                        fullfile(pwd, 'somedir4', 'mylib.library')};

makeInfo.precompile = 1;
makeInfo.library(1).Name = 'myprecompiledlib';
makeInfo.library(1).Location = fullfile(pwd, 'somedir2', 'lib');
makeInfo.library(1).Modules = {'srcfile1' 'srcfile2' 'srcfile3' };
```

---

**Note** If a path that you specify in the `rtwmakecfg.m` API contains spaces, the Simulink Coder software does not automatically convert the path to its non-space equivalent. If the build environments you intend to support do not support spaces in paths, refer to “Enabling the Simulink® Coder™ Software to Build When Path Names Contain Spaces” on page 9-44 in the Simulink Coder documentation.

---

**Modifying the Template Makefile.** To expand the information generated by an `rtwmakecfg` function, you can modify the following sections of your target’s TMF:

- Include Path
- C Flags and/or Additional Libraries
- Rules

The TMF code examples below may not apply to your make utility. For additional examples, see the GRT or ERT TMFs located in `matlabroot/rtw/c/grt/*.tmf` or `matlabroot/rtw/c/ert/*.tmf`.

#### Example — Adding Folder Names to the Makefile Include Path

The following TMF code example adds folder names to the include path in the generated makefile:

```
ADD_INCLUDES = \  
|>START_EXPAND_INCLUDES<|   -I|>EXPAND_DIR_NAME<| \  
|>END_EXPAND_INCLUDES<|
```

Additionally, the `ADD_INCLUDES` macro must be added to the `INCLUDES` line, as shown below.

```
INCLUDES = -I. -I.. $(MATLAB_INCLUDES) $(ADD_INCLUDES) $(USER_INCLUDES)
```

#### Example — Adding Library Names to the Makefile

The following TMF code example adds library names to the generated makefile.

```
LIBS =
|>START_PRECOMP_LIBRARIES<|
LIBS += |>EXPAND_LIBRARY_NAME<|.a |>END_PRECOMP_LIBRARIES<|
|>START_EXPAND_LIBRARIES<|
LIBS += |>EXPAND_LIBRARY_NAME<|.a |>END_EXPAND_LIBRARIES<|
```

For more information on how to use configuration parameters to control library names and location during the build process, see “Control Library Location and Naming During Build” on page 22-7 in the Simulink Coder documentation.

### Example — Adding Rules to the Makefile

The following TMF code example adds rules to the generated makefile.

```
|>START_EXPAND_RULES<|
$(BLD)/%.o: |>EXPAND_DIR_NAME<|/%.c $(SRC)/$(MAKEFILE) rtw_proj.tmw
    @$(BLANK)
    @echo ### " |>EXPAND_DIR_NAME<|\$.c"
    $(CC) $(CFLAGS) $(APP_CFLAGS) -o $(BLD)$(DIRCHAR)$*.o \
    |>EXPAND_DIR_NAME<|$(DIRCHAR)$*.c > $(BLD)$(DIRCHAR)$*.lst
|>END_EXPAND_RULES<|

|>START_EXPAND_LIBRARIES<|MODULES_|>EXPAND_LIBRARY_NAME<| = \
|>START_EXPAND_MODULES<|    |>EXPAND_MODULE_NAME<|.o \
|>END_EXPAND_MODULES<|

|>EXPAND_LIBRARY_NAME<|.a : $(MAKEFILE) rtw_proj.tmw
$(MODULES_|>EXPAND_LIBRARY_NAME<|:%.o=$(BLD)/%.o)
    @$(BLANK)
    @echo ### Creating $@
    $(AR) -r $@ $(MODULES_|>EXPAND_LIBRARY_NAME<|:%.o=$(BLD)/%.o)
|>END_EXPAND_LIBRARIES<|

|>START_PRECOMP_LIBRARIES<|MODULES_|>EXPAND_LIBRARY_NAME<| = \
|>START_EXPAND_MODULES<|    |>EXPAND_MODULE_NAME<|.o \
|>END_EXPAND_MODULES<|

|>EXPAND_LIBRARY_NAME<|.a : $(MAKEFILE) rtw_proj.tmw
```

```
$(MODULES_|>EXPAND_LIBRARY_NAME<|:%.o=$(BLD)/%.o)
  @$(BLANK)
  @echo ### Creating $@
  $(AR) -r $@ $(MODULES_|>EXPAND_LIBRARY_NAME<|:%.o=$(BLD)/%.o)
|>END_PRECOMP_LIBRARIES<|
```

## Supporting Continuous Time in Custom Targets

If you want your custom ERT-based target to support continuous time, you must update your template makefile (TMF) and the static main program module (for example, `mytarget_main.c`) for your target.

**Template Makefile Modifications.** Add the `NCSTATES` token expansion after the `NUMST` token expansion, as follows:

```
NUMST = |>NUMST<|
NCSTATES = |>NCSTATES<|
```

In addition, add `NCSTATES` to the `CPP_REQ_DEFINES` macro, as in the following example:

```
CPP_REQ_DEFINES = -DMODEL=$(MODEL) -DNUMST=$(NUMST) -DNCSTATES=$(NCSTATES) \
-DMAT_FILE=$(MAT_FILE)
-DINTEGER_CODE=$(INTEGER_CODE) \
-DONESTEPFCN=$(ONESTEPFCN) -DTERMFCN=$(TERMFCN) \
-DHAVESTDIO
-DMULTI_INSTANCE_CODE=$(MULTI_INSTANCE_CODE) \
```

**Modifications to Main Program Module.** The main program module defines a static main function that manages task scheduling for all supported tasking modes of single- and multiple-rate models. `NUMST` (the number of sample times in the model) determines whether the main function calls multirate or single-rate code. However, when a model uses continuous time, do not rely on `NUMST` directly.

When the model has continuous time and the flag `TID01EQ` is true, both continuous time and the fastest discrete time are treated as one rate in generated code. The code associated with the fastest discrete rate is guarded by a major time step check. When the model has only two rates, and `TID01EQ` is true, the generated code has a single-rate call interface.

To support models that have continuous time, update the static main module to take TID01EQ into account, as follows:

- 1 Before NUMST is referenced in the file, add the following code:

```
#if defined(TID01EQ) && TID01EQ == 1 && NCSTATES == 0
#define DISC_NUMST (NUMST - 1)
#else
#define DISC_NUMST NUMST
#endif
```

- 2 Replace all instances of NUMST in the file by DISC\_NUMST.

### **Model Reference Considerations**

See “Support Model Referencing” on page 24-101 for important information on TMF modifications you may need to make to support the Simulink Coder model referencing features.

---

**Note** If you are using a TMF without the variables SHARED\_SRC or MODELREFS, the file might have been used with a previous release of Simulink software. If you want your TMF to support model referencing, add either variable SHARED\_SRC or MODELREFS to the make file.

---

### **Generating Make Commands for Nondefault Compilers**

Custom targets might need a target-specific hook file to generate a make command when you use a nondefault compiler. Use this file to override the default behavior for selecting the compiler tool for the build process. See “STF\_wrap\_make\_cmd\_hook.m” on page 24-23 for further details.

## Support Optional Features

In this section...
“Overview” on page 24-100
“Support Model Referencing” on page 24-101
“Support Compiler Optimization Level Control” on page 24-115
“Support firstTime Argument Control” on page 24-117
“Support C Function Prototype Control” on page 24-119
“Support C++ Encapsulation Interface Control” on page 24-121

### Overview

This chapter describes how to configure a custom embedded target to support any of the following optional features:

Optional Feature	Target Configuration Parameters
Building a model that includes referenced models	ModelReferenceCompliant ParMdlRefBuildCompliant (parallel build support)
Controlling the compiler optimization level for building generated code	CompOptLevelCompliant
Controlling inclusion of the <code>firstTime</code> argument in the <code>model_initialize</code> function generated for a Simulink model.	ERTFirstTimeCompliant (ERT only)
Controlling the C function prototypes of initialize and step functions that are generated for a Simulink model	ModelStepFunctionPrototypeControl-Compliant (ERT only)
Generating and configuring C++ encapsulation interfaces to model code	CPPClassGenCompliant (ERT only)

The required configuration changes are modifications to your system target file (STF), and in some cases also modifications to your template makefile (TMF) or your custom static main program.

The API for STF callbacks provides a function `SelectCallback` for use in STFs. `SelectCallback` is associated with the target rather than with any of its individual options. If you implement a `SelectCallback` function for a target, it is triggered whenever the user selects the target in the System Target File Browser.

Additionally, the API provides the functions `slConfigUIGetVal`, `slConfigUISetEnabled`, and `slConfigUISetVal` for controlling custom target configuration options from a user-written `SelectCallback` function. (For function descriptions and examples, see the function reference pages.)

The general requirements for supporting one of the optional features include:

- To support model referencing or compiler optimization level control, the target must be derived from the GRT or the ERT target. To support `firstTime` argument control, C function prototype control, or C++ encapsulation interface control, the target must be derived from the ERT target.
- The system target file (STF) must declare feature compliance by including one of the target configuration parameters listed above in a `SelectCallback` function call.
- Additional changes such as TMF modifications or static main program modifications may be required, depending on the feature. See the detailed steps in the subsections for individual features.

## Support Model Referencing

- “Overview” on page 24-102
- “Declaring Model Referencing Compliance” on page 24-103
- “Providing Model Referencing Support in the TMF” on page 24-104
- “Controlling Configuration Option Value Agreement” on page 24-107
- “Supporting the Shared Utilities Folder” on page 24-108

- “Verifying Worker Configuration for Parallel Builds of Model Reference Hierarchies (Optional)” on page 24-112
- “Preventing Resource Conflicts (Optional)” on page 24-114

## Overview

This section describes how to configure a custom embedded target to support model referencing. Without the described modifications, you will not be able to use the custom target when building a model that includes referenced models. If you do not intend to use referenced models with your target, you can skip this section. If you later find that you need to use referenced models, you can upgrade your target then.

The requirements for supporting model referencing are as follows:

- The target must be derived from the GRT target or the ERT target.
- The system target file (STF) must declare model reference compliance, as described in “Declaring Model Referencing Compliance” on page 24-103.
- The template makefile (TMF) must define some entities that support model referencing, as described in “Providing Model Referencing Support in the TMF” on page 24-104.
- The TMF must support using the Shared Utilities folder, as described in “Supporting the Shared Utilities Folder” on page 24-108.

Optionally, you can provide additional capabilities that support model referencing:

- You can configure a target to support parallel builds for large model reference hierarchies (see “Reduce Build Time for Referenced Models” on page 15-28 in the Simulink Coder documentation). To do this, you must modify the STF and TMF for parallel builds as described in “Declaring Model Referencing Compliance” on page 24-103 and “Providing Model Referencing Support in the TMF” on page 24-104.
- If your target supports parallel builds for large model reference hierarchies, you can additionally set up automatic verification of MATLAB Distributed Computing Server (MDCS) workers, as described in “Verifying Worker Configuration for Parallel Builds of Model Reference Hierarchies (Optional)” on page 24-112.



- You can modify hook files to handle referenced models differently than top models to prevent resource conflicts, as described in “Preventing Resource Conflicts (Optional)” on page 24-114.

See “Overview of Model Referencing” for information about model referencing in Simulink models, and “Generate Code for Referenced Models” on page 3-4 for information about model referencing in Simulink Coder generated code.

## Declaring Model Referencing Compliance

To declare model reference compliance for your target, you must implement a callback function that sets the `ModelReferenceCompliant` flag, and then install the callback function in the `SelectCallback` field of the `rtwgensettings` structure in your STF. The callback function is triggered whenever the user selects the target in the System Target File Browser. For example, the following STF code installs a `SelectCallback` function named `custom_select_callback_handler`:

```
rtwgensettings.SelectCallback = 'custom_select_callback_handler(hDlg, hSrc)';
```

The arguments to the `SelectCallback` function (`hDlg`, `hSrc`) are handles to private data used by the callback API functions. These handles are restricted to use in STF callback functions. They should be passed in without alteration.

Your callback function should set the `ModelReferenceCompliant` flag as follows:

```
sIConfigUISetVal(hDlg, hSrc, 'ModelReferenceCompliant', 'on');
sIConfigUISetEnabled(hDlg, hSrc, 'ModelReferenceCompliant', false);
```

If you might use the target to build models containing large model reference hierarchies, consider configuring the target to support parallel builds, as discussed in “Reduce Build Time for Referenced Models” on page 15-28 in the Simulink Coder documentation.

To configure a target for parallel builds, your callback function must also set the `ParMdlRefBuildCompliant` flag as follows:

```
sIConfigUISetVal(hDlg, hSrc, 'ParMdlRefBuildCompliant', 'on');
sIConfigUISetEnabled(hDlg, hSrc, 'ParMdlRefBuildCompliant', false);
```

For more information about the STF callback API, see the `slConfigUIGetVal`, `slConfigUISetEnabled`, and `slConfigUISetVal` function reference pages.

### Providing Model Referencing Support in the TMF

Do the following to configure the template makefile (TMF) to support model referencing:

- 1 Add the following make variables and tokens to be expanded when the makefile is generated:

```

MODELREFS           = |>MODELREFS<|
MODELLIB            = |>MODELLIB<|
MODELREF_LINK_LIBS  = |>MODELREF_LINK_LIBS<|
MODELREF_LINK_RSPFILE = |>MODELREF_LINK_RSPFILE_NAME<|
MODELREF_INC_PATH   = |>START_MDLREFINC_EXPAND_INCLUDES<|\
    -I|>MODELREF_INC_PATH<| |>END_MDLREFINC_EXPAND_INCLUDES<|
RELATIVE_PATH_TO_ANCHOR = |>RELATIVE_PATH_TO_ANCHOR<|
MODELREF_TARGET_TYPE = |>MODELREF_TARGET_TYPE<|

```

The following code excerpt shows how makefile tokens are expanded for a referenced model.

```

MODELREFS           =
MODELLIB            = engine3200cc_rtwlib.a
MODELREF_LINK_LIBS  =
MODELREF_LINK_RSPFILE =
MODELREF_INC_PATH   =
RELATIVE_PATH_TO_ANCHOR = ../../..
MODELREF_TARGET_TYPE = RTW

```

The following code excerpt shows how makefile tokens are expanded for the top model that references the referenced model.

```

MODELREFS           = engine3200cc transmission
MODELLIB            = archlib.a
MODELREF_LINK_LIBS  = engine3200cc_rtwlib.a transmission_rtwlib.a
MODELREF_LINK_RSPFILE =
MODELREF_INC_PATH   = -I../slprj/ert/engine3200cc -I../slprj/ert/transmission
RELATIVE_PATH_TO_ANCHOR = ..
MODELREF_TARGET_TYPE = NONE

```

Token	Expands to
MODELREFS for the top model	List of referenced model names.
MODELLIB	Name of the library generated for the model.
MODELREF_LINK_LIBS token for the top model	List of referenced model libraries that the top model links against.
MODELREF_LINK_RSPFILE token for the top model	Name of a response file that the top model links against. This token is valid only for build environments that support linker response files. For an example of its use, see <i>matlabroot/rtw/c/grt/grt_vc.tmf</i> .
MODELREF_INC_PATH token for the top model	Include path to the referenced models.
RELATIVE_PATH_TO_ANCHOR	Relative path, from the location of the generated makefile, to the MATLAB working folder.
MODELREF_TARGET_TYPE	Signifies the type of target being built. Possible values are <ul style="list-style-type: none"> <li>• NONE: Standalone model or top model referencing other models</li> <li>• RTW: Model reference Simulink Coder target build</li> <li>• SIM: Model reference simulation target build</li> </ul>

If you are configuring your target to support parallel builds, as discussed in “Reduce Build Time for Referenced Models” on page 15-28 in the Simulink Coder documentation, you must also add the following token definitions to your TMF:

```
START_DIR = |>START_DIR<|
MASTER_ANCHOR_DIR = |>MASTER_ANCHOR_DIR<|
```

Token	Expands to
START_DIR	Current work folder (pwd) at the time the build started.
MASTER_ANCHOR_DIR	Current work folder (pwd) at the time the build started.

- 2** Add `RELATIVE_PATH_TO_ANCHOR` and `MODELREF_INC_PATH` include paths to the overall `INCLUDES` variable.

```
INCLUDES = -I. -I$(RELATIVE_PATH_TO_ANCHOR) $(MATLAB_INCLUDES) $(ADD_INCLUDES) \
          $(USER_INCLUDES) $(MODELREF_INC_PATH) $(SHARED_INCLUDES)
```

- 3** Change the `SRCS` variable in your `TMF` so that it initially lists only common modules. Additional modules are then appended conditionally, as described in the next step. For example, change

```
SRCS = $(MODEL).c $(MODULES) ert_main.c $(ADD_SRCS) $(EXT_SRC)
```

to

```
SRCS = $(MODULES) $(S_FUNCTIONS)
```

- 4** Create variables to define the final target of the makefile. You can remove any variables that may have existed for defining the final target. For example, remove

```
PROGRAM = ../$(MODEL)
```

and replace it with

```
ifeq ($(MODELREF_TARGET_TYPE), NONE)
  # Top model for RTW
  PRODUCT          = $(RELATIVE_PATH_TO_ANCHOR)/$(MODEL)
  BIN_SETTING      = $(LD) $(LDFLAGS) -o $(PRODUCT) $(SYSLIBS)
  BUILD_PRODUCT_TYPE = "executable"
  # ERT based targets
  SRCS             += $(MODEL).c ert_main.c $(EXT_SRC)
  # GRT based targets
  # SRCS           += $(MODEL).c grt_main.c rt_sim.c $(EXT_SRC) $(SOLVER)
```

```

else
  # sub-model for RTW
  PRODUCT          = $(MODELLIB)
  BUILD_PRODUCT_TYPE = "library"
endif

```

- 5** Create rules for the final target of the makefile (replace any existing final target rule). For example:

```

ifeq ($(MODELREF_TARGET_TYPE),NONE)
  # Top model for RTW
  $(PRODUCT) : $(OBJS) $(SHARED_LIB) $(LIBS) $(MODELREF_LINK_LIBS)
               $(BIN_SETTING) $(LINK_OBJS) $(MODELREF_LINK_LIBS)
               $(SHARED_LIB) $(LIBS)
               @echo "### Created $(BUILD_PRODUCT_TYPE): @"
else
  # sub-model for RTW
  $(PRODUCT) : $(OBJS) $(SHARED_LIB) $(LIBS)
               @rm -f $(MODELLIB)
               $(ar) rvs $(MODELLIB) $(LINK_OBJS)
               @echo "### Created $(MODELLIB)"
               @echo "### Created $(BUILD_PRODUCT_TYPE): @"
endif

```

- 6** Create a rule to allow submodels to compile files that reside in the MATLAB working folder (pwd).

```

%.o : $(RELATIVE_PATH_TO_ANCHOR)/%.c
      $(CC) -c $(CFLAGS) $<

```

---

**Note** If you are using a TMF without the variables `SHARED_SRC` or `MODELREFS`, the file might have been used with a previous release of Simulink software. If you want your TMF to support model referencing, add either variable `SHARED_SRC` or `MODELREFS` to the make file.

---

## Controlling Configuration Option Value Agreement

By default, the value of any configuration option defined in the system target file for a TLC-based custom target must be the same in any referenced

model and its parent model. To relax this requirement, include the `modelReferenceParameterCheck` field in the `rtwoptions` structure element that defines the configuration option, and set the value of the field to 'off'. For example:

```
rtwoptions(2).prompt          = 'My Custom Parameter';
rtwoptions(2).type            = 'Checkbox';
rtwoptions(2).default         = 'on';
rtwoptions(2).modelReferenceParameterCheck = 'on';
rtwoptions(2).tlcvariable     = 'mytlcvariable';
...
```

The configuration option **My Custom Parameter** can differ in a referenced model and its parent model. See “Customize System Target Files” on page 24-36 for information about TLC-based system target files, and `rtwoptions` Structure Fields Summary on page 24-50 for a list of all `rtwoptions` fields.

## Supporting the Shared Utilities Folder

- “Overview” on page 24-108
- “Implementing Shared Utilities Folder Support” on page 24-110

**Overview.** The makefile used by the Simulink Coder build process must support compiling and creating libraries, and so on, from the locations in which the code is generated. Therefore, you need to update your makefile and the model reference build process to support the shared utilities location. The **Shared code placement** options have the following requirements:

- Auto
  - Standalone model build — All files go to the build folder; no makefile updates.
  - Referenced model or top model build — Use shared utilities folder; makefile requires full model reference support.
- Shared location
  - Standalone model build — Use shared utilities folder; makefile requires shared location support.

- Referenced model or top model build — Use shared utilities folder; makefile requires full model reference support.

The shared utilities folder (`slprj/target/_sharedutils`) typically stores generated utility code that is common between a top model and the models it references. You can also force the build process to use a shared utilities folder for a standalone model. See “Project Folder Structure for Model Reference Targets” on page 3-16 in the Simulink Coder documentation for details.

If you want your target to support compilation of code generated in the shared utilities folder, several updates to your template makefile (TMF) are required. Support for Model Reference builds requires the shared utilities folder. See the preceding sections of this chapter to learn about additional updates for supporting Model Reference builds.

The exact syntax of the changes can vary due to differences in the make utility and compiler/archiver tools used by your target. The examples below are based on the GNU<sup>18</sup> make utility. You can find the following updated TMF examples for GNU and Microsoft Visual C++ make utilities in the GRT and ERT target folders:

- GRT: `matlabroot/rtw/c/grt/`
  - `grt_lcc.tmf`
  - `grt_vc.tmf`
  - `grt_unix.tmf`
- ERT: `matlabroot/rtw/c/ert/`
  - `ert_lcc.tmf`
  - `ert_vc.tmf`
  - `ert_unix.tmf`

Use the GRT or ERT examples as a guide to the location, within the TMF, of the changes and additions described below.

---

18. GNU® is a registered trademark of the Free Software Foundation.

---

**Note** The ERT-based TMFs contain extra code to handle generation of ERT S-functions and Model Reference simulation targets. Your target does not need to handle these cases.

---

**Implementing Shared Utilities Folder Support.** Make the following changes to your TMF to support the shared utilities folder:

- 1 Add the following make variables and tokens to be expanded when the makefile is generated:

```
SHARED_SRC      = |>SHARED_SRC<|
SHARED_SRC_DIR  = |>SHARED_SRC_DIR<|
SHARED_BIN_DIR  = |>SHARED_BIN_DIR<|
SHARED_LIB      = |>SHARED_LIB<|
```

SHARED\_SRC specifies the shared utilities folder location and the source files in it. A typical expansion in a makefile is

```
SHARED_SRC      = ../slprj/ert/_sharedutils/*.c
```

SHARED\_LIB specifies the library file built from the shared source files, as in the following expansion.

```
SHARED_LIB      = ../slprj/ert/_sharedutils/rtwshared.lib
```

SHARED\_SRC\_DIR and SHARED\_BIN\_DIR allow specification of separate folders for shared source files and the library compiled from the source files. In the current release, all TMFs use the same path, as in the following expansions.

```
SHARED_SRC_DIR  = ../slprj/ert/_sharedutils
SHARED_BIN_DIR  = ../slprj/ert/_sharedutils
```

- 2 Set the SHARED\_INCLUDES variable according to whether shared utilities are in use. Then append it to the overall INCLUDES variable.

```
SHARED_INCLUDES =
ifneq ($(SHARED_SRC_DIR),)
SHARED_INCLUDES = -I$(SHARED_SRC_DIR)
endif
```



```
INCLUDES = -I. $(MATLAB_INCLUDES) $(ADD_INCLUDES) \
           $(USER_INCLUDES) $(SHARED_INCLUDES)
```

- 3** Update the SHARED\_SRC variable to list all shared files explicitly.

```
SHARED_SRC := $(wildcard $(SHARED_SRC))
```

- 4** Create a SHARED\_OBJS variable based on SHARED\_SRC.

```
SHARED_OBJS = $(addsuffix .o, $(basename $(SHARED_SRC)))
```

- 5** Create an OPTS (options) variable for compilation of shared utilities.

```
SHARED_OUTPUT_OPTS = -o $@
```

- 6** Provide a rule to compile the shared utility source files.

```
$(SHARED_OBJS) : $(SHARED_BIN_DIR)/%.o : $(SHARED_SRC_DIR)/%.c
$(CC) -c $(CFLAGS) $(SHARED_OUTPUT_OPTS) $<
```

- 7** Provide a rule to create a library of the shared utilities. The following example is based on UNIX<sup>19</sup>.

```
$(SHARED_LIB) : $(SHARED_OBJS)
@echo "### Creating $@"
ar r $@ $(SHARED_OBJS)
@echo "### Created $@"
```

19. UNIX<sup>®</sup> is a registered trademark of The Open Group in the United States and other countries.

---

**Note** Depending on your make utility, you may be able to combine Steps 6 and 7 into one rule. For example, `gmake` (used with `ert_unix.tmf`) uses:

```
$(SHARED_LIB) : $(SHARED_SRC)
    @echo "### Creating $@"
    cd $(SHARED_BIN_DIR); $(CC) -c $(CFLAGS) $(GCC_WALL_FLAG_MAX) $(notdir $?)
    ar ruvs $@ $(SHARED_OBJS)
    @echo "### $@ Created "
```

See this and other examples in the files `ert_vc.tmf`, `ert_lcc.tmf`, and `ert_unix.tmf` located at `matlabroot/rtw/c/ert`.

---

- 8 Add `SHARED_LIB` to the rule that creates the final executable.

```
$(PROGRAM) : $(OBJS) $(LIBS) $(SHARED_LIB)
    $(LD) $(LDFLAGS) -o $@ $(LINK_OBJS) $(LIBS)
$(SHARED_LIB) $(SYSLIBS)
    @echo "### Created executable: $(MODEL)"
```

- 9 Remove any explicit reference to `rt_nonfinite.c` from your TMF. For example, change

```
ADD_SRCS = $(RTWLOG) rt_nonfinite.c
```

to

```
ADD_SRCS = $(RTWLOG)
```

---

**Note** If your target interfaces to a development environment that is not makefile based, you must make equivalent changes to provide information to your target compilation environment.

---

## Verifying Worker Configuration for Parallel Builds of Model Reference Hierarchies (Optional)

If your target supports parallel builds for large model reference hierarchies, you can additionally set up automatic verification of MATLAB Distributed Computing Server (MDCS) workers. This addresses the possibility that

parallel workers might have different configurations, some of which might not be compatible with a specific target build. For example, the required compiler might not be installed on a worker system.

Simulink Coder provides a programming interface that you can use to automatically check the configuration of parallel workers. If parallel workers are not set up as expected, take action, such as reverting to sequential builds or throwing an error.

To set up automatic verification of MDCS workers, you must define a parallel configuration check function named *STF\_par\_cfg\_chk*, where *STF* designates your system target file name. For example, the parallel configuration check function for `ert.tlc` is `ert_par_cfg_chk`.

The general syntax for the function is:

```
function varargout = STF_par_cfg_chk(action, varargin)
```

The number of output and input arguments vary according to the *action* specified, and according to the types of information you choose to coordinate between the client and the workers. The function should support the following general sequence of parallel configuration setup calls, differentiated by the first argument passed in:

Call Syntax	Called on:	Action
<code>cfg = STF_par_cfg_chk('getPreferredCfg');</code>	MDCS client	Return a structure representing the preferred configuration for MDCS workers.
<code>[tf, cfg] = STF_par_cfg_chk('getWorkerCfg', cfg);</code>	MDCS workers	Each worker is passed the MDCS client's preferred configuration. Return true if the worker can support the preferred configuration; otherwise return false along with a structure representing a configuration the worker can support. Information returned by each worker is added to a cell array of configurations.

Call Syntax	Called on:	Action
<code>[tf, cfg] = STF_par_cfg_chk ('getCommonCfg', cfgs);</code>	MDCS client	The client is passed the cell array of worker configurations. If a usable common configuration exists, return true, and return the common configuration to set for all systems. If a common configuration cannot be established, return false or take some action, such as reverting to sequential builds or throwing an error.
<code>tf = STF_par_cfg_chk ('setCommonCfg', cfg);</code>	MDCS workers and client	Each system is passed the common configuration to use. Set up the common configuration and, if successful, return true. If any errors or issues occur, return false or take some action, such as reverting to sequential builds or throwing an error.
<code>STF_par_cfg_chk ('clearCfg');</code>	MDCS workers and client	Clean up after completion of the parallel build.

The parallel configuration check functions for MathWorks provided targets are implemented as wrapper functions that call a function named `parallelMdlRefHostConfigCheckFcn`. For example, see the ERT parallel configuration check function in the file `matlabroot/toolbox/rtw/rtw/ert_par_cfg_chk.m`, and the function it calls in the file `matlabroot/toolbox/simulink/simulink/+Simulink/parallelMdlRefHostConfigCheckFcn.m`. The `parallelMdlRefHostConfigCheckFcn` function tries to establish a common compiler across the MDCS client and workers.

For more information about parallel builds, see “Reduce Build Time for Referenced Models” on page 15-28 in the Simulink Coder documentation.

### Preventing Resource Conflicts (Optional)

Hook files are optional `.m` and `TLC` files that are invoked at well-defined stages of the build process. Hook files let you customize the build process and communicate information between various phases of the process.

If you are adapting your custom target for code generation compatibility with model reference features, consider adding checks to your hook files for handling referenced models differently than top models to prevent resource conflicts.

For example, consider adding the following check to your `STF_make_rtw_hook.m` file:

```
% Check if this is a referenced model
mdlRefTargetType = get_param(codeGenModelName, 'ModelReferenceTargetType');
isNotModelRefTarget = strcmp(mdlRefTargetType, 'NONE'); % NONE, SIM, or RTW
if isNotModelRefTarget
    % code that is specific to the top model
else
    % code that is specific to the referenced model
end
```

You may need to do a similar check in your TLC code.

```
%if !IsModelReferenceTarget()
    %% code that is specific to the top model
%else
    %% code that is specific to the referenced model
%endif
```

## Support Compiler Optimization Level Control

- “Overview” on page 24-115
- “Declaring Compiler Optimization Level Control Compliance” on page 24-116
- “Providing Compiler Optimization Level Control Support in the Target Makefile” on page 24-117

### Overview

This chapter describes how to configure a custom embedded target to support compiler optimization level control. Without the described modifications, you will not be able to use the **Compiler optimization level** parameter on the **Code Generation** pane of the Configuration Parameters dialog box to control the compiler optimization level for building generated code. (For

more information about compiler optimization level control, see “Compiler optimization level” in the Simulink Coder reference documentation.)

The requirements for supporting compiler optimization level control are as follows:

- The target must be derived from the GRT target or the ERT target.
- The system target file (STF) must declare compiler optimization level control compliance, as described in “Declaring Compiler Optimization Level Control Compliance” on page 24-116.
- The target makefile must honor the setting for **Compiler optimization level**, as described in “Providing Compiler Optimization Level Control Support in the Target Makefile” on page 24-117.

### **Declaring Compiler Optimization Level Control Compliance**

To declare compiler optimization level control compliance for your target, you must implement a callback function that sets the `CompOptLevelCompliant` flag, and then install the callback function in the `SelectCallback` field of the `rtwgensettings` structure in your STF. The callback function is triggered whenever the user selects the target in the System Target File Browser. For example, the following STF code installs a `SelectCallback` function named `custom_select_callback_handler`:

```
rtwgensettings.SelectCallback = 'custom_select_callback_handler(hDlg, hSrc)';
```

The arguments to the `SelectCallback` function (`hDlg`, `hSrc`) are handles to private data used by the callback API functions. These handles are restricted to use in STF callback functions. They should be passed in without alteration.

Your callback function should set the `CompOptLevelCompliant` flag as follows:

```
s1ConfigUISetVal(hDlg, hSrc, 'CompOptLevelCompliant', 'on');  
s1ConfigUISetEnabled(hDlg, hSrc, 'CompOptLevelCompliant', false);
```

For more information about the STF callback API, see the `s1ConfigUIGetVal`, `s1ConfigUISetEnabled`, and `s1ConfigUISetVal` function reference pages.

When the `CompOptLevelCompliant` target configuration parameter is set to on, the **Compiler optimization level** parameter is displayed in the **Code Generation** pane of the Configuration Parameters dialog box for your model.

## Providing Compiler Optimization Level Control Support in the Target Makefile

As part of supporting compiler optimization level control for your target, you must modify the target makefile to honor the setting for **Compiler optimization level**. Use a GRT or ERT target provided by MathWorks as a model for making the modifications.

## Support firstTime Argument Control

- “Overview” on page 24-117
- “Declaring firstTime Argument Control Compliance” on page 24-118
- “Providing firstTime Argument Control Support in the Custom Static Main Program” on page 24-119

### Overview

This chapter describes how to configure a custom embedded target to support `firstTime` argument control. Without the described modifications, you will not be able to use the `IncludeERTFirstTime` model configuration parameter to control inclusion of the `firstTime` argument in the `model_initialize` function generated for your model. (For more information about `firstTime` argument control, see `model_initialize` in the Embedded Coder reference documentation.)

The requirements for supporting `firstTime` argument control are as follows:

- The target must be derived from the ERT target.
- The system target file (STF) must declare `firstTime` argument control compliance, as described in “Declaring firstTime Argument Control Compliance” on page 24-118.
- If your target uses a custom static main program, the main program must handle the inclusion and suppression of the `firstTime` argument for

a given model, as described in “Providing firstTime Argument Control Support in the Custom Static Main Program” on page 24-119.

### **Declaring firstTime Argument Control Compliance**

To declare firstTime argument control compliance for your target, you must implement a callback function that sets the `ERTFirstTimeCompliant` flag, and then install the callback function in the `SelectCallback` field of the `rtwgensettings` structure in your STF. The callback function is triggered whenever the user selects the target in the System Target File Browser. For example, the following STF code installs a `SelectCallback` function named `custom_select_callback_handler`:

```
rtwgensettings.SelectCallback = 'custom_select_callback_handler(hDlg, hSrc)';
```

The arguments to the `SelectCallback` function (`hDlg`, `hSrc`) are handles to private data used by the callback API functions. These handles are restricted to use in STF callback functions. They should be passed in without alteration.

Your callback function should set the `ERTFirstTimeCompliant` flag as follows:

```
slConfigUISetVal(hDlg, hSrc, 'ERTFirstTimeCompliant', 'on');  
slConfigUISetEnabled(hDlg, hSrc, 'ERTFirstTimeCompliant', false);
```

For more information about the STF callback API, see the `slConfigUIGetVal`, `slConfigUISetEnabled`, and `slConfigUISetVal` function reference pages.

When the `ERTFirstTimeCompliant` target configuration parameter is set to on, you can use the `IncludeERTFirstTime` model configuration parameter to control inclusion of the `firstTime` argument in the `model_initialize` function generated for your model.

---

**Note** If the `ERTFirstTimeCompliant` parameter is set to off for your selected target, you cannot control inclusion of the `firstTime` argument in the `model_initialize` function. If you attempt to include or suppress the `firstTime` argument using the `IncludeERTFirstTime` model configuration parameter, Embedded Coder software ignores the request, and your generated `model_initialize` function will not reflect the requested change.

---



## Providing firstTime Argument Control Support in the Custom Static Main Program

If your target uses a custom static main program, you must update the static main program to handle the inclusion and suppression of the `firstTime` argument for a given model. One way to do this is to

- 1 Check that the target TLC file assigns 1 to `AutoBuildProcedure` when using a static main program. For example,

```
%assign AutoBuildProcedure = !GenerateSampleERTMain
```

- 2 In the generated header file `autobuild.h`, the macro `INCLUDE_FIRST_TIME_ARG` will be set to 0 if the `IncludeERTFirstTime` parameter is set to `off` or 1 if the parameter is set to `on`.
- 3 Inside the static main program, do `#include autobuild.h` and then conditionally compile declarations and calls to the `model_initialize` function, based on the value of the `INCLUDE_FIRST_TIME_ARG` macro.

## Support C Function Prototype Control

- “Overview” on page 24-119
- “Declaring C Function Prototype Control Compliance” on page 24-120
- “Providing C Function Prototype Control Support in the Custom Static Main Program” on page 24-121

### Overview

This chapter describes how to configure a custom embedded target to support C function prototype control. Without the described modifications, you will not be able to use the **Configure Model Functions** button on the **Interface** pane of the Configuration Parameters dialog box to control the function prototypes of initialize and step functions that are generated for your model. (For more information about C function prototype control, see “Function Prototype Control” in the Embedded Coder documentation.)

The requirements for supporting C function prototype control are as follows:

- The target must be derived from the ERT target.

- The system target file (STF) must declare C function prototype control compliance, as described in “Declaring C Function Prototype Control Compliance” on page 24-120.
- If your target uses a custom static main program, and if a nondefault function prototype control configuration is associated with a model, the static main program must call the function prototype controlled initialize and step functions, as described in “Providing C Function Prototype Control Support in the Custom Static Main Program” on page 24-121.

### **Declaring C Function Prototype Control Compliance**

To declare C function prototype control compliance for your target, you must implement a callback function that sets the `ModelStepFunctionPrototypeControlCompliant` flag, and then install the callback function in the `SelectCallback` field of the `rtwgensettings` structure in your STF. The callback function is triggered whenever the user selects the target in the System Target File Browser. For example, the following STF code installs a `SelectCallback` function named `custom_select_callback_handler`:

```
rtwgensettings.SelectCallback = 'custom_select_callback_handler(hDlg, hSrc)';
```

The arguments to the `SelectCallback` function (`hDlg`, `hSrc`) are handles to private data used by the callback API functions. These handles are restricted to use in STF callback functions. They should be passed in without alteration.

Your callback function should set the `ModelStepFunctionPrototypeControlCompliant` flag as follows:

```
s1ConfigUISetVal(hDlg, hSrc, 'ModelStepFunctionPrototypeControlCompliant', 'on');  
s1ConfigUISetEnabled(hDlg, hSrc, 'ModelStepFunctionPrototypeControlCompliant', false);
```

For more information about the STF callback API, see the `s1ConfigUIGetVal`, `s1ConfigUISetEnabled`, and `s1ConfigUISetVal` function reference pages.

When the `ModelStepFunctionPrototypeControlCompliant` target configuration parameter is set to on, you can use the **Configure Model Functions** button on the **Interface** pane of the Configuration Parameters dialog box to control the function prototypes of initialize and step functions that are generated for your model.

## Providing C Function Prototype Control Support in the Custom Static Main Program

If your target uses a custom static main program, and if a nondefault function prototype control configuration is associated with a model, you must update the static main program to call the function prototype controlled initialize and step functions. You can do this in either of the following ways:

- 1 Manually adapt your static main program to declare model data and call the function prototype controlled initialize and step functions.
- 2 Generate your main program using **Generate an example main program** on the **Templates** pane of the Configuration Parameters dialog box. The generated main program declares model data and calls the function prototype controlled initialize and step function.

## Support C++ Encapsulation Interface Control

- “Overview” on page 24-121
- “Declaring C++ Encapsulation Interface Control Compliance” on page 24-122

### Overview

This chapter describes how to configure a custom embedded target to support C++ encapsulation interface control. Without the described modifications, you will not be able to use the C++ (Encapsulated) language option and the **Configure C++ Encapsulation Interface** button on the **Interface** pane of the Configuration Parameters dialog box to generate and configure C++ encapsulation interfaces to model code. (For more information about C++ encapsulation interface control, see “C++ Encapsulation Interface Control” in the Embedded Coder documentation.)

The requirements for supporting C++ encapsulation interface control are as follows:

- The target must be derived from the ERT target.
- The system target file (STF) must declare C++ encapsulation interface control compliance, as described in “Declaring C++ Encapsulation Interface Control Compliance” on page 24-122.

## Declaring C++ Encapsulation Interface Control Compliance

To declare C++ encapsulation interface control compliance for your target, you must implement a callback function that sets the `CPPClassGenCompliant` flag, and then install the callback function in the `SelectCallback` field of the `rtwgensettings` structure in your STF. The callback function is triggered whenever the user selects the target in the System Target File Browser. For example, the following STF code installs a `SelectCallback` function named `custom_select_callback_handler`:

```
rtwgensettings.SelectCallback = 'custom_select_callback_handler(hDlg, hSrc)';
```

The arguments to the `SelectCallback` function (`hDlg`, `hSrc`) are handles to private data used by the callback API functions. These handles are restricted to use in STF callback functions. They should be passed in without alteration.

Your callback function should set the `CPPClassGenCompliant` flag as follows:

```
slConfigUISetVal(hDlg, hSrc, 'CPPClassGenCompliant', 'on');  
slConfigUISetEnabled(hDlg, hSrc, 'CPPClassGenCompliant', false);
```

For more information about the STF callback API, see the `slConfigUIGetVal`, `slConfigUISetEnabled`, and `slConfigUISetVal` function reference pages.

When the `CPPClassGenCompliant` target configuration parameter is set to `on`, you can use the **C++ (Encapsulated)** language option and the **Configure C++ Encapsulation Interface** button on the **Interface** pane of the Configuration Parameters dialog box to generate and configure C++ encapsulation interfaces to model code.

---

**Note** Selecting the **C++ (Encapsulated)** language value for your model turns on the model option **Generate an example main program**. With this option on, code generation generates an example main program, `ert_main.cpp`. The generated example main program declares model data and calls the C++ encapsulation interface configured model step method, and illustrates how the generated code can be deployed.

---

## Interface to Development Tools

### In this section...

“About Interfacing to Development Tools” on page 24-123

“Makefile Approach” on page 24-124

“Interface to an Integrated Development Environment” on page 24-124

### About Interfacing to Development Tools

Unless you are developing a target purely for code generation purposes, you will want your embedded target to support a complete build process. A full post-code generation build process includes

- Compilation of generated code
- Linking of compiled code and runtime libraries into an executable program module (or some intermediate representation of the executable code, such as S-Rec format)
- Downloading the executable to target hardware with a debugger or other utility
- Initiating execution of the downloaded program

Supporting a complete build process is inherently a complex task, because it involves interfacing to cross-development tools and utilities that are external to the Simulink Coder software.

If your development tools can be controlled with traditional makefiles and a make utility such as `gmake`, it may be relatively simple for you to adapt existing target files (such as the `ert.tlc` and `ert.tmf` files provided by the Embedded Coder software) to your requirements. This approach is discussed in “Makefile Approach” on page 24-124.

Automating your build process through a modern integrated development environment (IDE) presents a different set of challenges. Each IDE has its own way of representing the set of source files and libraries for a project and for specifying build arguments. Interfacing to an IDE may require generation of specialized file formats required by the IDE (for example, project files)

and, and also may require the use of inter-application communication (IAC) techniques to run the IDE. One such approach to build automation is discussed in “Interface to an Integrated Development Environment” on page 24-124.

## **Makefile Approach**

A template makefile provides information about your model and your development system. The build process uses this information to create a makefile (.mk file) to build an executable program. The Embedded Coder product provides a number of template makefiles suitable for host-based compilers such as LCC (`ert_lcc.tmf`) and Microsoft Visual C++ (`ert_vc.tmf`).

Adapting one of the existing template makefiles to your cross-compiler’s make utility may require little more than copying and renaming the template makefile in accordance with the conventions of your project.

If you need to make more extensive modifications, you need to understand template makefiles in detail. For a detailed description of the structure of template makefiles and of the tokens used in template makefiles, see “Customize Template Makefiles” on page 24-75.

The following sections of this document supplement the basic template makefile information in the Simulink Coder documentation:

- “Supporting Multiple Development Environments” on page 24-60
- “Supplying Development Environment Information to Your Template Makefile” on page 24-33
- “mytarget\_default\_tmf.m” on page 24-22

## **Interface to an Integrated Development Environment**

- “Introduction” on page 24-125
- “Generating a CPP\_REQ\_DEFINES Header File” on page 24-125
- “Interfacing to the Freescale CodeWarrior IDE” on page 24-126

## Introduction

This section describes techniques that have been used to integrate embedded targets with integrated development environment (IDEs), including

- How to generate a header file containing directives to define variables (and their values) required by a non-makefile based build.
- Some problems and solutions specific to interfacing embedded targets with the Freescale Semiconductor CodeWarrior IDE. The examples provided should help you to deal with similar interfacing problems with your particular IDE.

## Generating a CPP\_REQ\_DEFINES Header File

In Simulink Coder template makefiles, the token `CPP_REQ_DEFINES` is expanded and replaced with a list of parameter settings entered with various dialog boxes. This variable often contains information such as `MODEL` (name of generating model), `NUMST` (number of sample times in the model), `MT` (model is multitasking or not), and numerous other parameters (see “Template Makefiles and Tokens” on page 24-75).

The Simulink Coder makefile mechanism handles the `CPP_REQ_DEFINES` token automatically. If your target requires use of a project file, rather than the traditional makefile approach, you can generate a header file containing directives to define these variables and provide their values.

The following TLC file, `gen_rtw_req_defines.tlc`, provides an example. The code generates a C header file, `cpp_req_defines.h`. The information required to generate each `#define` directive is derived either from information in the `model.rtw` file (e.g., `CompiledModel.NumSynchronousSampleTimes`), or from make variables from the `rtwoptions` structure (e.g., `PurelyIntegerCode`).

```
%% File: gen_rtw_req_defines_h.tlc
%openfile CPP_DEFINES = "cpp_req_defines.h"
#ifdef _CPP_REQ_DEFINES_
#define _CPP_REQ_DEFINES_
#define MODEL %<CompiledModel.Name>
#define ERT 1
#define NUMST %<CompiledModel.NumSynchronousSampleTimes>
#define TID01EQ %<CompiledModel.FixedStepOpts.TID01EQ>
%%
```

```
%if CompiledModel.FixedStepOpts.SolverMode == "MultiTasking"
#define MT 1
#define MULTITASKING 1
#else
#define MT 0
#define MULTITASKING 0
#endif
%%
#define MAT_FILE 0
#define INTEGER_CODE %<PurelyIntegerCode>
#define ONESTEPFCN %<CombineOutputUpdateFcns>
#define TERMFCN %<IncludeMdlTerminateFcn>
%%
#define MULTI_INSTANCE_CODE 0
#define HAVESTDIO 0
#endif
%closefile CPP_DEFINES
```

## Interfacing to the Freescale CodeWarrior IDE

Interfacing an embedded target's build process to the CodeWarrior IDE requires that two problems must be dealt with:

- The build process must generate a CodeWarrior compatible project file. This problem, and a solution, is discussed in “XML Project Import” on page 24-126. The solution described is applicable to any ASCII project file format.
- During code generation, the target must automate a CodeWarrior session that opens a project file and builds an executable. This task is described in “Build Process Automation” on page 24-131. The solution described is applicable to any IDE that can be controlled with Microsoft Component Object Model (COM) automation.

**XML Project Import.** This section illustrates how to use the Target Language Compiler (TLC) to generate an eXtensible Markup Language (XML) file, suitable for import into the CodeWarrior IDE, that contains information about the source code generated by an embedded target.



The choice of XML format is dictated by the fact that the CodeWarrior IDE supports project export and import with XML files. As of this writing, native CodeWarrior project files are in a proprietary binary format.

Note that if your target needs to support some other compiler's project file format, you can apply the techniques shown here to virtually any ASCII file format (see "Generating a CPP\_REQ\_DEFINES Header File" on page 24-125).

To illustrate the basic concept, consider a hypothetical XML file exported from a CodeWarrior stationery project. The following is a partial listing:

```
<target>
  <settings>
    ...
  <\settings>
  <file><name>foo.c<\name>
  <\file>
  ...
  <file><name>foobar.c<\name>
  <\file>
  <fileref><name>foo.c<\name>
  <\fileref>
  ...
  <fileref><name>foobar.c<\name>
  <\fileref>
<\target>
```

Insert this XML code into an `%openfile/%closefile` block within a TLC file, `test.tlc`, as shown below.

```
%% test.tlc
%% This code will generate a file model_project.xml,
%% where model is the generating model name specified in
%% the CompiledModel.Name field of the model.rtw file.
%openfile XMLFileContents = %<CompiledModel.Name>_project.xml
<target>
  <settings>
    ...
  <\settings>
  <file><name>%<CompiledModel.Name>.c<\name>
  <\file>
    ...
  <file><name>foobar.c<\name>
  <\file>
  <fileref><name>%<CompiledModel.Name>.c<\name>
  <\fileref>
    ...
  <fileref><name>foobar.c<\name>
  <\fileref>
<\target>
%closefile XMLFileContents
%selectfile NULL_FILE
```

Note the use of the TLC token `CompiledModel.Name`. The token is resolved and the resulting filename is included in the output stream. You can specify other information, such as paths and libraries, in the output stream by specifying other tokens defined in `model.rtw`. For example, `System.Name` may be defined as `<Root>/Subsystem1`.

Now suppose that `test.tlc` is invoked during a target's build process, where the generating model is `mymodel`. This should be done after the `codegenentry` statement. For example, `test.tlc` could be included directly in the system target file:

```
%include "codegenentry.tlc"
%include "test.tlc"
```

Alternatively, the `%include "test.tlc"` directive could be inserted into the `mytarget_genfiles.tlc` hook file, if present.

TLC tokens such as

```
<file><name>%<CompiledModel.Name>.c<\name>
```

are expanded, with the `CompiledModel` record in the `mymodel.rtw` file, as in

```
<file><name>mymodel.c<\name>
```

`test.tlc` generates an XML file, file `model_project.xml`, from any model. `model_project.xml` contains references to generated code files. `model_project.xml` can be imported into the CodeWarrior IDE as a project.

The following flowchart summarizes this process.

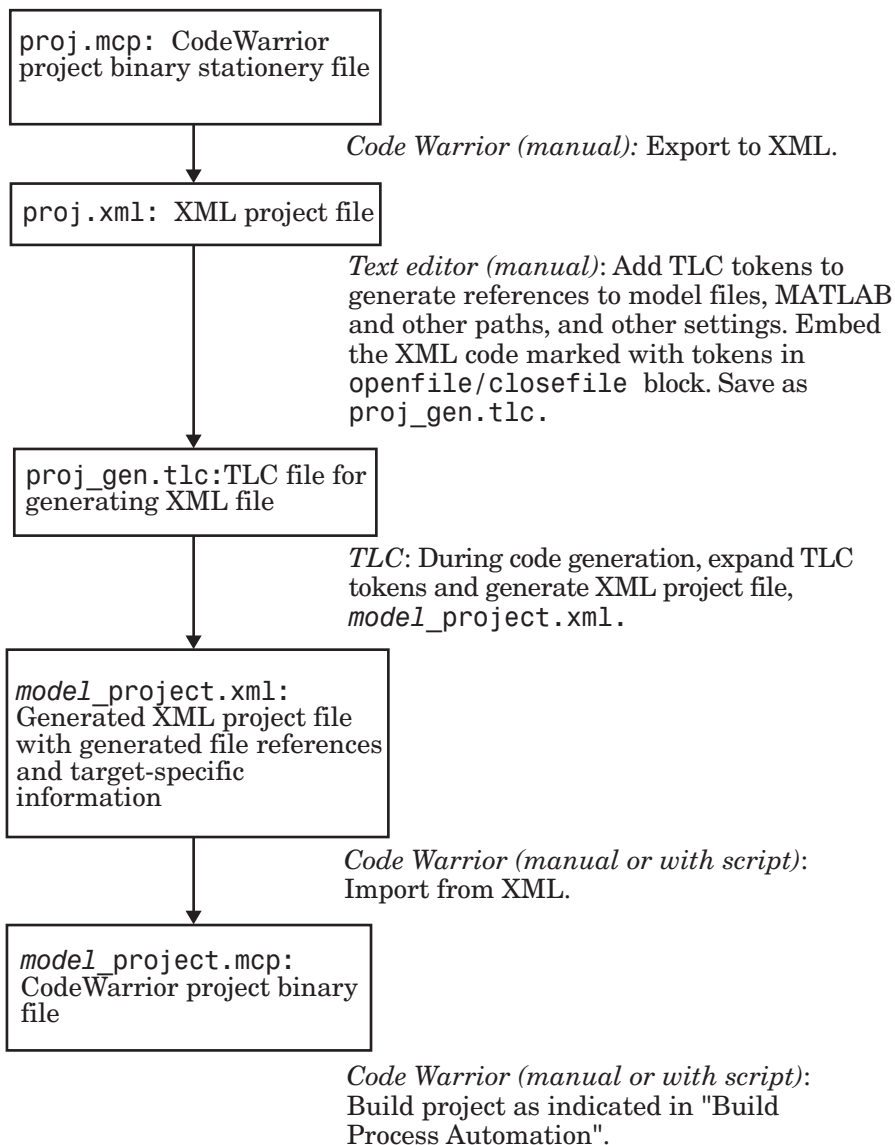

---

**Note** This process has drawbacks. First, manually editing an XML file exported from a CodeWarrior stationary project can be a laborious task, involving modification of a few dozen lines embedded within several thousand lines of XML code. Second, if you make changes to the CodeWarrior project after importing the generated XML file, the XML file must be exported and manually edited once again.

---

**Build Process Automation.** An application that supports COM automation can control any other application that includes a COM interface. Using MATLAB COM automation functions, a MATLAB file can command a COM-compatible development system to execute tasks required by the build process.

The MATLAB COM automation functions described in this section are documented in “COM Objects”.

For information about automation commands supported by the CodeWarrior IDE, see your CodeWarrior documentation.

COM automation is used by some embedded targets to automate the CodeWarrior IDE to execute tasks such as:

- Opening a new CodeWarrior session
- Configure a project
- Loading a CodeWarrior project file
- Removing object code from the project
- Building or rebuilding the project
- Debug an application

COM technology automates certain repetitive tasks and allows the user to interact directly with the external application. For example, when the end user of the embedded targets capability initiates a build, the target quickly invokes CodeWarrior actions and leaves a project built and ready to run with the IDE.

## Example COM Automation Functions

The functions below use the MATLAB `actxserver` command to invoke COM functions for controlling the CodeWarrior IDE from a MATLAB file:

- `CreateCWComObject`: Create a COM connection to the CodeWarrior IDE.
- `OpenCW`: Open the CodeWarrior IDE without opening a project.
- `OpenMCP`: Open the CodeWarrior project file (`.mcp` file) specified by the input argument.
- `BuildCW`: Open the specified `.mcp` file, remove object code, and build project.

These functions are examples; they do not constitute a full implementation of a COM automation interface. If your target creates the project file during code generation, the top-level `BuildCW` function should be called after the code generation process is completed. Normally `BuildCW` would be called from the exit method of your `STF_make_rtw_hook.m` file (see “`STF_make_rtw_hook.m`” on page 24-23).

In the code examples, the variable `in_qualifiedMCP` is assumed to store a fully qualified path to a CodeWarrior project file (for example, path, filename, and extension). For example:

```
in_qualifiedMCP = 'd:\work\myproject.mcp';
```

In actual practice, your code is responsible for determining the conventions used for the project filename and location. One simple convention would be to default to a project file `model.mcp`, located in your target’s build folder. Another approach would be to let the user specify the location of project files with the target preferences.

```
%=====
% Function: CreateCWComObject
% Abstract: Creates the COM connection to CodeWarrior
%
function ICodeWarriorApp = CreateCWComObject
    vprint([mfilename ' : creating CW com object']);
    try
        ICodeWarriorApp = actxserver('CodeWarrior.CodeWarriorApp');
    catch
```

```

        error(['Error creating COM connection to ' ComObj ...
            '. Verify that CodeWarrior is installed. Verify COM access to
CodeWarrior outside of MATLAB.']);
    end
    return;

%=====
% Function: OpenCW
% Abstract: Opens CodeWarrior without opening a project. Returns the
%         handle ICodeWarriorApp.
%
function ICodeWarriorApp = OpenCW()
    ICodeWarriorApp = CreateCWComObject;
    CloseAll;
    OpenMCP(in_qualifiedMCP);

%=====
% Function: OpenMCP
% Abstract: open an MCP project file
%
function OpenMCP(in_qualifiedMCP)
    % Argument checking. This method requires valid project file.
    if ~exist(in_qualifiedMCP)
        error(['filename ': Missing or empty project file argument']);
    end
    if isempty(in_qualifiedMCP)
        error(['filename ': Missing or empty project file argument']);
    end
    ICodeWarriorApp = CreateCWComObject;
    vprint(['filename ': Importing']);
    try
        ICodeWarriorProject = ...
            invoke(ICodeWarriorApp.Application,...
                'OpenProject', in_qualifiedMCP,...
                1,0,0);
    catch
        error(['Error using COM connection to import project. ' ...
            '. Verify that CodeWarrior is installed. Verify COM access to

```

```
CodeWarrior outside of MATLAB.']);
    end

%=====
% Function: BuildCW
% Abstract: Opens CodeWarrior.
%           Opens the specified CodeWarrior project.
%           Deletes objects.
%           Builds.
%
function ICodeWarriorApp = BuildCW(in_qualifiedMCP)
    % ICodeWarriorApp = BuildCW;
    ICodeWarriorApp = CreateCWComObject;
    CloseAll;
    OpenMCP(in_qualifiedMCP);
    try
        invoke(ICodeWarriorApp.DefaultProject,'RemoveObjectCode', 0, 1);
    catch
        error(['Error using COM connection to remove objects of current project. ' ...
            'Verify that CodeWarrior is installed. Verify COM access to
CodeWarrior outside of MATLAB.']);
    end
    try
        invoke(ICodeWarriorApp.DefaultProject,'BuildAndWaitToComplete');
    catch
        error(['Error using COM connection to build current project. ' ...
            'Verify that CodeWarrior is installed. Verify COM access to
CodeWarrior outside of MATLAB.']);
    end
end
```



# Device Drivers and Target Preferences

**In this section...**

“Integrate Device Drivers” on page 24-135

“Use Target Preferences” on page 24-135

## Integrate Device Drivers

Device drivers that communicate with target hardware are essential to many real-time development projects.

You can integrate existing C (or C++) device driver functions into Simulink models by using the Legacy Code Tool. When you use the Simulink Coder product to generate code from a model, the Legacy Code Tool can insert a call to your C function into the generated code. For details, see “Integrate External Code Using Legacy Code Tool” on page 14-28 and “Example of Integrating Existing C Functions into Simulink Models with the Legacy Code Tool”.

Embedded Coder target support provides the Target Block Builder Tool for integrating custom device driver code with the algorithmic code generated by code generation software. If you have the Embedded Coder product, see the Texas Instruments C6000 example “Custom Device Driver Integration via Target Block Builder Tool”.

## Use Target Preferences

You may want to associate certain types of data with the target. For example, an embedded target might offer a choice of several supported development systems (cross-compilers, debuggers, and so on). To invoke a specific development tool during the build process, the target needs information such as the user’s choice of development tool, and the location on the host system where the user has installed the compiler and debugger executables. Other data associated with a target might specify host/target communications parameters, such as the communications port and baud rate to be used.

Target developers need to define and store the properties they want to associate with their target. End users need a simple mechanism to set target property values.

To define preferences to associate with your target, see the following function pages:

- `addpref`
- `getpref`
- `setpref`

# Desktop IDEs and Desktop Targets

---



# Project and Build Configurations for Desktop Targets

---

- “Model Setup” on page 25-2
- “IDE Projects” on page 25-16
- “Makefiles for Software Build Tool Chains” on page 25-19

## Model Setup

In this section...
“Block Selection” on page 25-2
“Target Preferences” on page 25-3
“Configuration Parameters” on page 25-7
“Model Reference” on page 25-14

### Block Selection

You can create models for targeting the same way you create other Simulink models—by combining standard blocks and C-MEX S-functions.

You can use blocks from the following sources:

- The Desktop Targets library (desktoptargetslib) in the Simulink Coder product.
- Blocks from the System Toolboxes products
- Custom blocks

Avoid using blocks that do not generate code, including the following blocks.

Block Name/Category	Library	Description
Scope	Simulink, DSP System Toolbox software	Provides oscilloscope view of your output. Do not use the <b>Save data to workspace</b> option on the <b>Data history</b> pane in the Scope Parameters dialog box.
To Workspace	Simulink	Return data to your MATLAB workspace.
From Workspace	Simulink	Send data to your model from your MATLAB workspace.

<b>Block Name/Category</b>	<b>Library</b>	<b>Description</b>
Spectrum Scope	DSP System Toolbox	Compute and display the short-time FFT of a signal. It has internal buffering that can slow your process without adding value.
Triggered to Workspace	DSP System Toolbox	Send data to your MATLAB workspace.
Signal To Workspace	DSP System Toolbox	Send a signal to your MATLAB workspace.
Signal From Workspace	DSP System Toolbox	Get a signal from your MATLAB workspace.
Triggered Signal From Workspace	DSP System Toolbox	Get a signal from your MATLAB workspace.
To Wave device	DSP System Toolbox	Send data to a .wav device.
From Wave device	DSP System Toolbox	Get data from a .wav device.

## Target Preferences

This topic contains the following subtopics:

- “Supported IDEs” on page 25-3
- “What is a Target Preferences Block?” on page 25-4
- “Adding a Target Preferences Block to Your Model” on page 25-4
- “Creating a Library of Customized Target Preferences Blocks” on page 25-6

## Supported IDEs

This “Target Preferences” on page 25-3 section applies to Eclipse™ IDE.

## **What is a Target Preferences Block?**

If you are preparing to generate code for a target processor, add a Target Preferences block to the model. You can use the Target Preferences block to specify information such as the processor, board, hardware settings, operating system, memory map, and code generation features. Simulink Coder, Embedded Coder, and Simulink products use this information to generate code from your model.

For detailed information about the Target Preference block parameters and options, consult the Target Preferences block reference topic.

---

## **Key Points**

- To generate code, the model must contain a Target Preferences block.
  - Use one Target Preferences block per model. Exceptions to this rule are noted in the documentation for specific features, such as “Model Block PIL” on page 26-3.
  - Changing Target Preferences block settings can change tabs, panes, parameters, and options visible when you open the block.
  - Adding a Target Preferences block to a model changes the values of some Configuration Parameters. If you need to preserve the Configuration Parameters of a specific model, make a backup copy of the model before adding a Target Preferences block to it.
- 

## **Adding a Target Preferences Block to Your Model**

To generate code, with few exceptions, your model must contain only one Target Preferences block.

- When you are generating code for a model, place the Target Preferences block at the top level of your model.
- When you are generating code for a subsystem in your model, place the Target Preferences block at the subsystem level of your model.

To add a Target Preferences block to your model:



- 1 Open the Simulink library browser.
- 2 Copy the Target Preferences block from the **Simulink Coder > Desktop Targets** library to your model
- 3 The software displays the **Initialize Configuration Parameters** dialog box. For example.

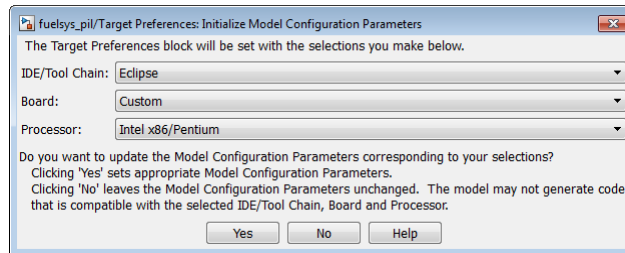

Set the following parameters, and click **Yes**:

- **IDE/Tool Chain**
- **Board**
- **Processor**

When you click **Yes**, the software automatically sets the model Configuration Parameters for the IDE/Tool Chain, Board, and Processor you selected. You have completed the process of adding a Target Preferences block to your model.

If you click **No**, the software leaves the values of the Configuration Parameters unchanged. The model cannot simulate or generate valid code unless you configure the Configuration Parameters with the right values. Setting these values manually can be difficult.

---

**Note** The following actions update some of the model Configuration Parameters with new values:

- Adding a Target Preferences block to your model and clicking **Yes** in the **Initialize Configuration Parameters** dialog box.
  - Opening the Target Preferences block in your model and selecting a new **IDE/Tool Chain**.
  - Opening the Target Preferences block in your model and applying changes to the **Board** and **Processor** parameters.
- 

---

**Note** The **Initialize Configuration Parameters** dialog box uses your previous selections for **IDE/Tool Chain**, **Board**, and **Processor** as default values the next time you copy a Target Preference block to a model.

---

### **Creating a Library of Customized Target Preferences Blocks**

If you work regularly with a variety of IDEs, tool chains, boards and processors, you can save time by creating a library of customized Target Preferences blocks. Later, you reuse these preconfigured Target Preferences blocks instead repeating the customization process on a new Target Preferences block.

To create a library of customized Target Preferences blocks:

- 1** In Simulink, select **File > New > Library**. This action creates a new untitled library.
- 2** Save the library to a folder included in your MATLAB search paths.

---

**Note** Click **File > Set Path** to see a list of MATLAB search paths and add new ones.

---

- 3** Copy or drag configured Target Preferences blocks from your models to the library.

**4** Edit the label of each block to describe that block's configuration.

**5** After the new blocks are added and labeled, save the library.

To copy a Target Preferences block from your library to a model, type the library name in the MATLAB Command Window. When the library appears, copy the block to your model.

## Configuration Parameters

- “What are Configuration Parameters?” on page 25-7
- “Setting Model Configuration Parameters” on page 25-7

### What are Configuration Parameters?

To see the model Configuration Parameters, open the **Configuration Parameters** dialog box. You can do this in the model editor by selecting **Simulation > Model Configuration Parameters**, or by pressing **Ctrl+E** on your keyboard.

The **Configuration Parameters** dialog box specifies the values for a model's active *configuration set*. These parameters determine the type of solver used, the import and export settings, and other values that determine how the model runs.

To set the Configuration Parameters to the right values for you to generate code from your model, add a Target Preferences block to your model. This action initializes the model Configuration Parameters to the right default values for you to generate code. You can then use the Configuration Parameters dialog box to make further modifications to the values.

### Setting Model Configuration Parameters

To apply the right default values in Configuration Parameters, add a Target Preferences block to your model and select the **Initialize Configuration Parameters**, as described in “Adding a Target Preferences Block to Your Model” on page 25-4. You can generate buildable code using these default values.

To make further changes, select **Simulation > Model Configuration Parameters** in the Model Editor, or press **Ctrl+E**. This action opens the **Configuration Parameters** dialog box.

The following subsections provide a quick overview of the panes and parameters with which you are most likely to interact.

**Code Generation Pane.** When you set **System target file** to `idelink_ert.tlc` or `idelink_grt.tlc`, the dialog box adds an **IDE Link** pane to the list of panes under **Code Generation**.

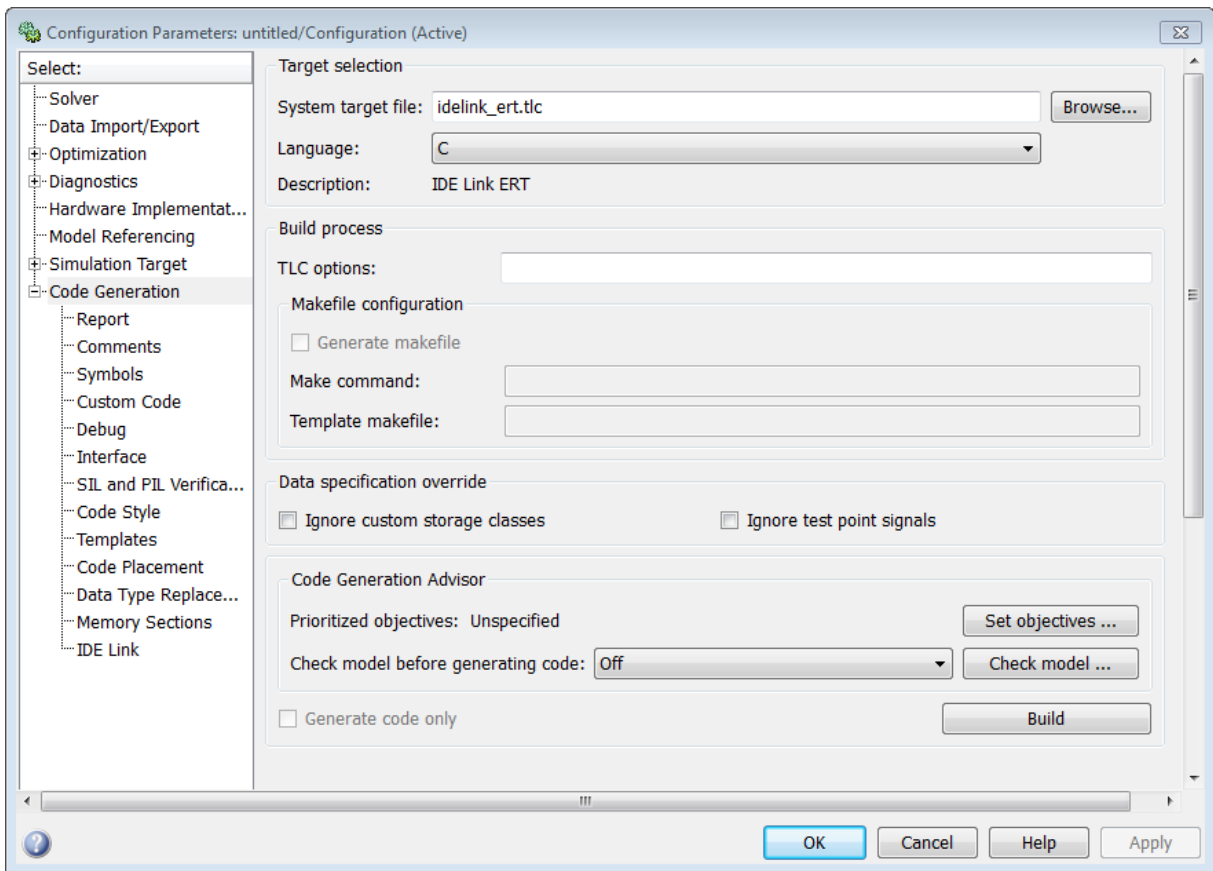

Setting the **System target file** to `idelink_ert.tlc` requires an Embedded Coder license.

Leave **Language** set to C. The `idelink_ert.tlc` and `idelink_grt.tlc` system target files do not support C++ code generation.

For more information, see “Code Generation Pane: General”

## IDE Link Pane Parameters.

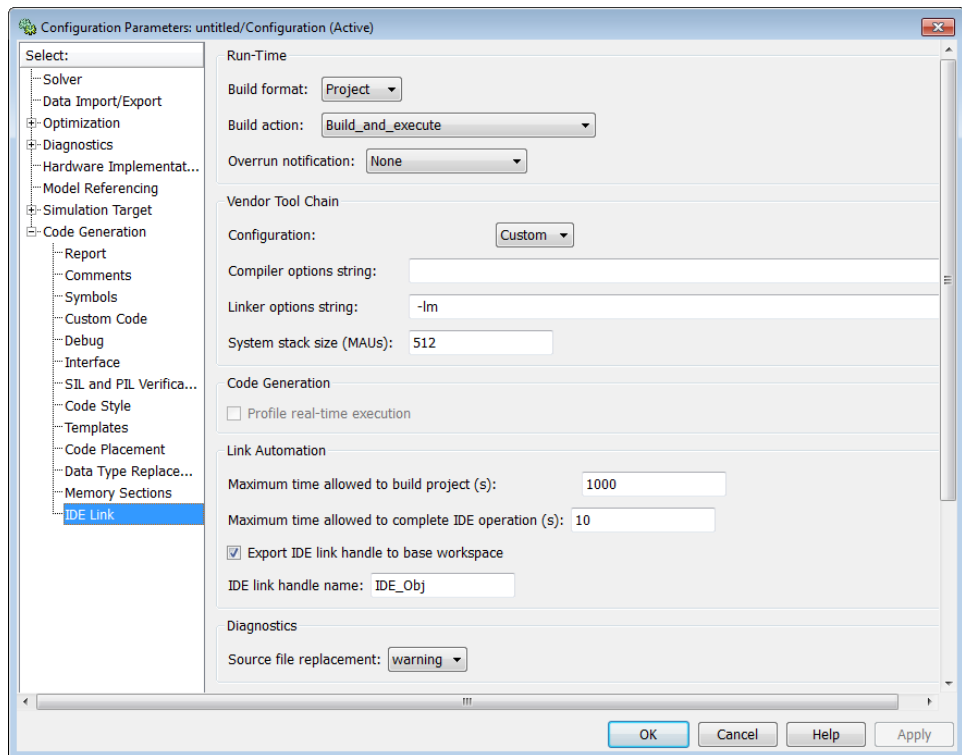

The IDE Link entry provides options in these areas:

- **Run-Time** — Set options for run-time operations, like the build action
- **Vendor Tool Chain** — Set compiler, linker, and system stack size options

- **Code Generation** — Configure your code generation requirements
- **Link Automation** — Export an IDE handle object, such as `IDE_Obj`, to your MATLAB workspace
- **Diagnostics** — Determine how the code generation process responds when you use source code replacement in the **Custom Code** pane.

For more information, see [Code Generation Pane: IDE Link](#).

### Build format

Select **Project** to create an IDE project, or select **Makefile** to create a makefile build script.

### Build action

Your selection for **Build action** determines what happens when you click **Build** or press **Ctrl+B**. Your selection tells Simulink Coder software when to stop the code generation and build process.

To run your model on the processor, select **Build\_and\_execute**. This selection is the default build action.

The actions are cumulative—each action performs an additional step relative to the preceding action on the list.

If you set **Build format** to **Project**, select one of the following options:

- **Create\_project** — Directs Simulink Coder software to start the IDE and populate a new project with the files from the build process. This option offers a convenient way to build projects in the IDE.
- **Archive\_library** — Directs Simulink Coder software to create an archive library for this model. Use this option when you plan to use the model in a model reference application. Model reference requires that you archive your the IDE projects for models that you use in model referencing.
- **Build** — Builds the executable file, but does not download the file to the target processor.

- `Build_and_execute` — Directs Simulink Coder software to build, download, and run your generated code as an executable on your target processor.
- `Create_processor_in_the_loop_project` — Directs code generation process to create PIL algorithm object code as part of the project build. This option requires an Embedded Coder license.

If you set **Build format** to `Makefile`, select one of the following options:

- `Create_makefile` — Creates a makefile.
- `Archive_library` — Creates a makefile and the generated output will be an archive library.
- `Build` — Creates a makefile and an executable.
- `Build_and_execute` — Creates a makefile and an executable. Then it evaluates the execute instruction in the current configuration.

## Overrun notification

To enable the overrun indicator, choose one of three ways for the target to respond to an overrun condition in your model:

- `None` — Ignore overruns encountered while running the model.
- `Print_message` — When the target encounters an overrun condition, it prints a message to the standard output device, `stdout`.
- `Call_custom_function` — Respond to overrun conditions by calling the custom function you identify in **Function name**.

## Function name

When you select `Call_custom_function` from the **Overrun notification** list, you enable this option. Enter the name of the function the target should use to notify you that an overrun condition occurred. The function must exist in your code on the target processor.

### Configuration

The **Configuration** parameter defines sets of build options that apply to all of the files generated from your model.

The **Release** and **Debug** option apply build settings that are defined by your compiler. For more information, refer to your compiler documentation.

**Custom** has the same default values as **Release**, but:

- Leaves **Compiler options string** empty.

### Compiler options string

To determine the degree of optimization provided by the optimizing compiler, enter the optimization level to apply to files in your project. For details about the compiler options, refer to your IDE documentation. When you create new projects, the coder product does not set any optimization flags.

### Linker options string

To specify the options provided by the linker during link time, you enter the linker options as a string. For details about the linker options, refer to your IDE documentation. When you create new projects, the coder product does not set any linker options.

### System stack size (MAUs)

Enter the amount of memory that is available for allocating stack data, measured in minimum addressable units (MAU). Block output buffers are placed on the stack until the stack memory is fully allocated. After that, the output buffers go in global memory. An MAU is typically 1 byte, but its size can vary by target processor.

This parameter is used in all targets to allocate the stack size for the generated application. For example, with embedded processors that are not running an operating system, this parameter determines the total stack space



that can be used for the application. For such as Linux or WindowsVxWorks operating systems, this value specifies the stack space allocated per thread.

This parameter also affects the “Maximum stack size (bytes)” parameter, located in the Optimization > Signals and Parameters pane.

## Link Automation

When you build a model for a target, the coder product automatically creates or uses an existing *IDE handle object* (named `IDE_Obj`, by default) to connect to your IDE.

Although `IDE_Obj` is a handle for a specific instance of the IDE, it also contains information about the IDE instance to which it refers, such as the target the IDE accesses. In this pane, the **Export IDE link handle to base workspace** option lets you instruct the coder product to export the object to your MATLAB workspace, giving it the name you assign in **IDE link handle name**.

You can also use the IDE handle object to interact with the IDE using IDE Automation Interface commands.

## Maximum time allowed to build project (s)

Specifies how long the software waits for the IDE to build the software.

## Maximum time allowed to complete IDE operation (s)

Specifies how long the software waits for IDE functions, such as `read` or `write`, to return completion messages. If you do not specify a timeout, the default value is 10 seconds.

## Export IDE link handle to base workspace

Directs the software to export the `IDE_Obj` object to your MATLAB workspace.

### IDE link handle name

Specifies the name of the IDE\_Obj object that the build process creates.

### Source file replacement

Selects the diagnostic action to take if the software detects conflicts when you replace source code with custom code. The diagnostic message responds to both source file replacement in the Configuration Parameters under Code Generation > IDE link parameters and under Code Generation > Custom Code.

The following settings define the messages you see and how the code generation process responds:

- **none** — Does not generate warnings or errors when it finds conflicts.
- **warning** — Displays a warning. warn is the default value.
- **error** — Terminates the build process and displays an error message that identifies which file has the problem and suggests how to resolve it.

The build operation continues if you select warning and the software detects custom code replacement problems. You see warning messages as the build progresses.

Select error the first time you build your project after you specify custom code to use. The error messages can help you diagnose problems with your custom code replacement files. Use none when the replacement process works and you do not want to see multiple messages during your build.

## Model Reference

The `idelink_ert.tlc` and `idelink_grt.tlc` system target files provide support for generating code from models that use Model Reference. A referenced model will generate an archive library.

To enable Model Reference builds:

- 1 Open your referenced model.

- 2** Select Simulation > Model Configuration Parameters from the model menus.
- 3** From the list of panes under **Code Generation**, choose **IDE Link**.
- 4** In the right pane, under Run-Time, select Archive\_library from the **Build action** list.

If your top-model uses a reference model that does not have the **Build action** set to Archive\_library, the build process automatically changes the **Build action** to Archive\_library and issues a warning about the change.

### **Target Preferences Blocks in Reference Models**

Include a configured Target Preferences block in each referenced model and the top-model . Configure all of the Target Preferences blocks for the same processor so that the software tool chain and build process is consistent across the model hierarchy.

## IDE Projects

In this section...
“Support for Third Party Products” on page 25-16
“Third Party Product Setup” on page 25-16
“Code Generation and Build” on page 25-16
“Automation of IDE Tasks and Processes” on page 25-17

### Support for Third Party Products

For more information about Simulink Coder support for Eclipse IDE, see <http://www.mathworks.com/products/simulink-coder/eclipse-adaptor.html>

### Third Party Product Setup

Install your third party IDE or software build tool chain according to the vendor’s instructions.

If you are using one of the following IDEs, perform the additional steps described here:

#### Eclipse IDE

Complete the instructions in “Installing Third-Party Software for Eclipse” on page 27-2 and in “Configuring Your MathWorks Software to Work with Eclipse” on page 27-10.

### Code Generation and Build

#### Building Your Model

In your model, click **Build Model** . The software performs the actions you selected for **Build action** in the model Configuration Parameters, under Code Generation > IDE Link.

## IDE Project Generator Features

The *IDE Project Generator* component provides or supports the following features for developing IDE projects and generating code:

- Automatically create IDE projects for your generated code during the code generation process.
- Customize code generation using options in the model Configuration Parameters and the Target Preferences block.
- Configure the automatic project build process.
- Automatically download and run your generated projects on your target processor.

## IDE Handle Objects

IDE Project Generator automatically creates and uses an IDE handle object to communicate with your IDE and target processor.

To create the IDE handle object for Eclipse IDE, IDE Project Generator uses the `eclipseide` constructor function. For a command line example, see the `eclipseide` reference page.

## Automation of IDE Tasks and Processes

The *IDE Automation Interface* component provides a powerful API for automating IDE tasks via MATLAB scripts. For example, with IDE Automation Interface, your script can automatically:

- Automate project creation, including adding source files, include paths, and preprocessor defines
- Configure batch building of projects
- Launch a debugging session

## Examples of IDE Automation Interface for Specific IDEs

To help you become familiar with IDE Automation Interface, you can use the “IDE Automation Interface Tutorial” example for Eclipse IDE.

The example shows you how to:

- 1** Configure and create an IDE handle object.
- 2** Create and query objects in an IDE.
- 3** Use MATLAB software to load files into your IDE.
- 4** Work with your IDE project from MATLAB software.
- 5** Close connections you the IDE.

# Makefiles for Software Build Tool Chains

## In this section...

“What is the XMakefile Feature” on page 25-19

“Using Makefiles to Generate and Build Software” on page 25-21

“Making an XMakefile Configuration Operational” on page 25-24

“Working with Microsoft® Visual Studio®” on page 25-24

“Creating a New XMakefile Configuration” on page 25-25

“XMakefile User Configuration Dialog Box” on page 25-31

## What is the XMakefile Feature

- “Overview” on page 25-19
- “Supported Tool Chains in Simulink® Coder™” on page 25-20
- “Available XMakefile Configurations” on page 25-20
- “Feature Support” on page 25-20

### Overview

You can use makefiles instead of IDE projects during the automated software build process. This approach is described in “Using Makefiles to Generate and Build Software” on page 25-21.

The XMakefile feature lets you choose the *configuration* of a specific software build tool chain to use during the automated build process. The configuration contains paths and settings for your make utility, compiler, linker, archiver, pre-build, post-build, and execute tools.

You can choose one built-in configuration described in and “Available XMakefile Configurations” on page 25-20.

You can also create a new configuration for a new tool chain, as described in “Creating a New XMakefile Configuration” on page 25-25.

Your requirements for specific features may determine whether you choose makefiles or IDE projects. See “Feature Support” on page 25-20.

### Supported Tool Chains in Simulink Coder

Simulink Coder includes support for the following IDEs and tool chains.

Tool Chain	Processor Family/Target Operating System	Host Operating System
GNU development tools	Linux	Linux
MinGW development tools	Windows	Windows
Microsoft Visual Studio	Windows	Windows

Embedded Coder includes support for other IDEs and tool chains. See Supported Tool Chains in Embedded Coder.

### Available XMakefile Configurations

The following list describes the configurations in the XMakefile dialog box that this product supports:

- `gcc_target`: GNU Compiler Collection & Host Operating System or Embedded Operating System
- `mingw_host`: Minimalist GNU for Windows & Host Operating System
- `msvs_host`: Microsoft Visual Studio & Host Operating System

For more information about supported versions of third-party software, see “Support for Third Party Products” on page 25-16

### Feature Support

With makefiles, you cannot use features that rely on direct communications between your MathWorks software and third-party IDEs.

You cannot use the following features with makefiles:



- IDE Project Generation
- IDE Automation Interface
- IDE debugger communications during Processor-in-the-loop (PIL) simulation

## Using Makefiles to Generate and Build Software

In addition to this chapter, see the Makefile Generator Tutorial example for more information about using makefiles to generate code.

### Configuring Your Model to Use Makefiles

Update your model Configuration Parameters to use a makefile instead of an IDE when you build software from the model:

- 1** Add a Target Preferences block to your model and configure it for your target processor. For more information, see “Target Preferences” on page 25-3.
- 2** In your Simulink Editor, select **Simulation > Model Configuration Parameters** or press **Ctrl+e**.
- 3** Under the **Code Generation** tab, select **IDE Link**.
- 4** Set **Build format** to **Makefile**. For more information, see **Build format** on page 10.
- 5** Set **Build action** to **Build\_and\_execute**. For more information, see **Build action** on page 10.

### Choosing an XMakefile Configuration

Configure how to generate makefiles:

- 1** Enter `xmakefilesetup` on the MATLAB Command Window. The software opens an XMakefile User Configuration dialog box.

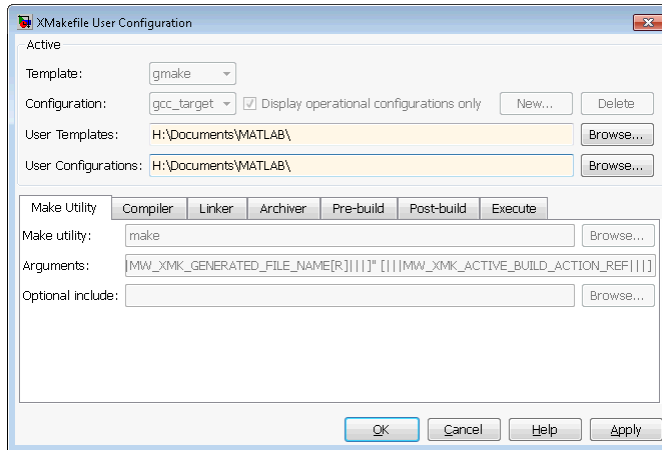

**2** Leave **Template** set to `gmake`.

**3** For **Configuration**, select `gcc_target` or `msvs_host` to match the compiler toolchain you are using — `gcc` or Microsoft Visual Studio, respectively. Click **Apply**.

---

**Note** Changing some elements of the XMakefile dialog box disables other elements until you apply the changes. Click **Apply** or **OK** after changing any of the following:

- **Template**
  - **Configurations**
  - **User Templates**
  - **User Configurations**
  - **Tool Directories**
-

---

**Note** With the XMakefile User Configuration dialog, if you have a Simulink Coder license but no Embedded Coder license, the only valid settings for **Configuration** are `gcc_target`, `mingw_host`, or `msvs_host`. The other configurations, though visible, are only supported by the Embedded Coder product.

---

---

**Note** If you set **Configuration** to `msvs_host`, restart MATLAB as described in “Working with Microsoft® Visual Studio®” on page 25-24 before building your model software.

---

Things to consider while setting **Configuration**:

- Selecting **Display operational configurations only** hides configurations that contain incomplete or invalid information. For a configuration to be operational, the vendor tool chain must be installed, and the configuration must have the valid paths for each component of the vendor tool chain. For more information, see “Making an XMakefile Configuration Operational” on page 25-24.
- To display all of the configurations, including non-operational configurations, clear **Display operational configurations only**.
- The list of configurations can include non-editable configurations defined in the software and editable configurations defined by you.
- To create a new editable configuration, use the **New** button.
- For more information, see “XMakefile User Configuration Dialog Box” on page 25-31.

## Building Your Model

In your model, click **Build Model** . This action creates a makefile and performs the other actions you specified in **Build action**.

By default, this process outputs files in the `<builddir>/<buildconfiguration>` folder. For example, in `model_name/CustomMW`.

## Making an XMakefile Configuration Operational

When the XMakefile utility starts, it checks each configuration file to verify that the specified paths for the vendor tool chain are valid. If the paths are not valid, the configuration is non-operational. Typically, the cause of this problem is a difference between the path in the configuration and the actual path of the vendor toolchain.

To make a configuration operational:

- 1 Clear **Display operational configurations only** to display non-operational configurations.
- 2 Select the non-operational configuration from the **Configuration** options.
- 3 When you click **Apply**, a new dialog box prompts you for the folder path of any missing resources the configuration requires.

Use mapped network drives instead of UNC paths to specify directory locations. Using UNC paths with compilers that do not support them causes build errors.

## Working with Microsoft Visual Studio

If you set **Configuration** to `msvs_host`, restart MATLAB from a Visual Studio® command prompt before building your model software with makefiles. The `vsvars32.bat` file associated with the Visual Studio command prompt configures the Visual Studio environment. Starting MATLAB from this command prompt results in a session that can generate makefiles from the `msvs_host` configuration.

To restart MATLAB from a Visual Studio command prompt:

- 1 Open a Visual Studio command prompt:
  - Select your MSVS product from the Windows **Start > Programs** menu.

- b** In **Visual Studio Tools**, select the **Visual Studio Command Prompt**.  
For example:



- 2** Enter `matlab` at the **Visual Studio Command Prompt**.  
**3** In MATLAB, open and build your model.

If you do not restart MATLAB from Microsoft Visual Studio command prompt, building your model software generates an error whose ending is similar to the following text:

```
The build failed with the following message:  
"C:/Program Files/Microsoft Visual Studio...  
3792 Abort C:/Program Files/Microsoft Visual Studio 8/VC/bin/cl  
gmake: *** [MW_csl.obj] Error 134
```

A related article is available on the Microsoft Web site at:  
<http://msdn.microsoft.com/en-us/library/1700bbwd.aspx>

## Creating a New XMakefile Configuration

- “Overview” on page 25-25
- “Create a Configuration” on page 25-26
- “Modify the Configuration” on page 25-27
- “Test the Configuration” on page 25-30

### Overview

This example shows you how to add support for a software development toolchain to the XMakefile utility. This example uses the Intel Compiler and Eclipse IDE, which provides an open framework and allows for otherwise unsupported toolchains.

---

**Note** To specify directory locations, use mapped network drives instead of UNC paths. UNC paths cause build errors with compilers that do not support them.

---

## Create a Configuration

When you click **New**, the new configuration inherits values and behavior from the current configuration. To create a configuration for the Intel Compiler, clone a configuration from any of these configurations: `msvs_host`, `mingw_host` and `gcc_target`.

---

**Note** The linker used by the Intel Compiler uses the Microsoft Visual Studio tool chain and therefore the execution environment must have access to these tools (`vcvars.bat`). For more information, see “Working with Microsoft® Visual Studio®” on page 25-24.

---

Open the XMakefile User Configuration UI by typing `xmakefilesetup` at the MATLAB prompt. This action displays the following dialog box.

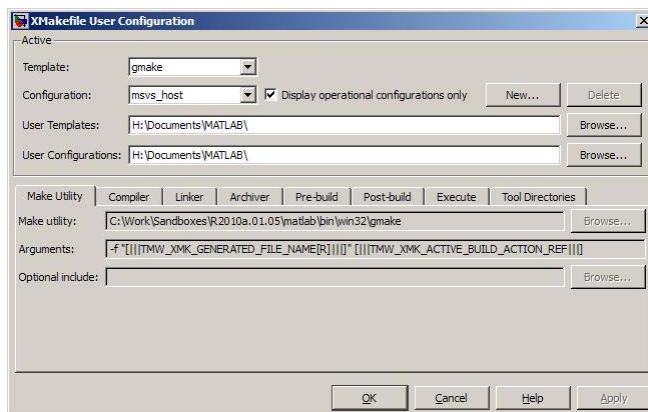

Select an existing configuration, such as `msvs_host`, `mingw_host`, `montavista_arm` or `gcc_target`. Click the **New** button.

A pop-up dialog prompts you for the name of the new configuration. Enter `intel_compiler` and click **OK**.



The dialog box displays a new configuration called `intel_compiler`, based on the previous configuration.

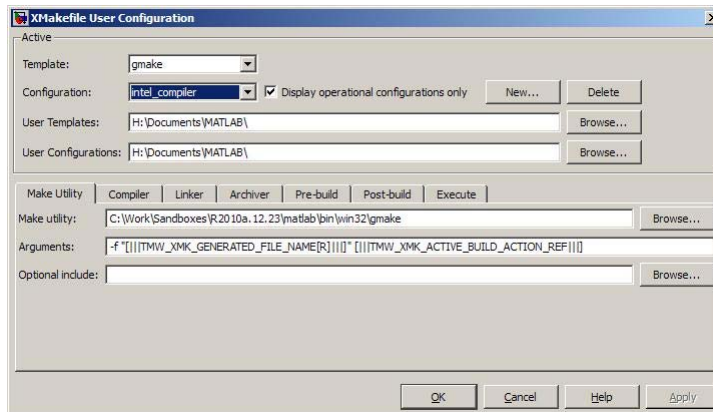

## Modify the Configuration

Adjust the compiler, linker, and archiver settings of the newly created configuration. This example assumes the location of the Intel compiler is `C:\Program Files\Intel\Compiler\`.

**Make Utility.** You do not need to make any changes. This configuration uses the `gmake` tool that ships with MATLAB.

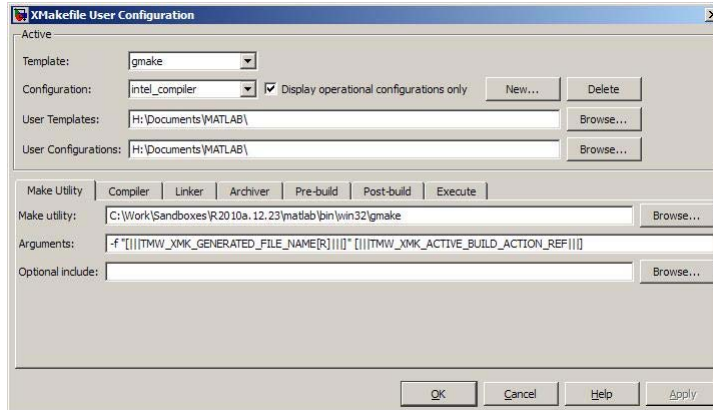

**Compiler.** For **Compiler**, enter the location of `icl.exe` in the Intel installation.

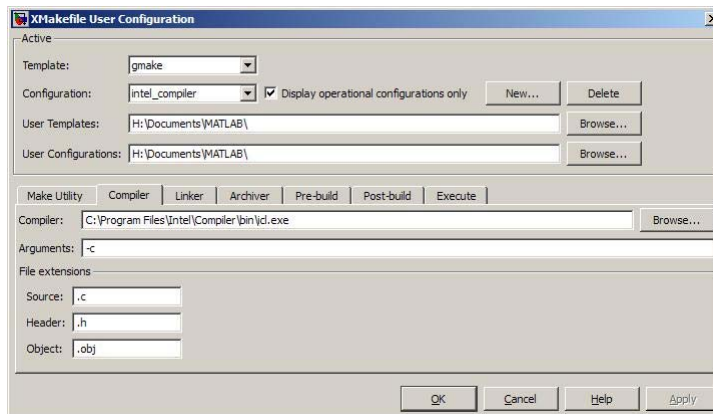

**Linker.** For **Linker**, enter the location of the linker executable, `xilink.exe`.

For **Arguments**, add the `/LIBPATH` path to the Intel libraries.



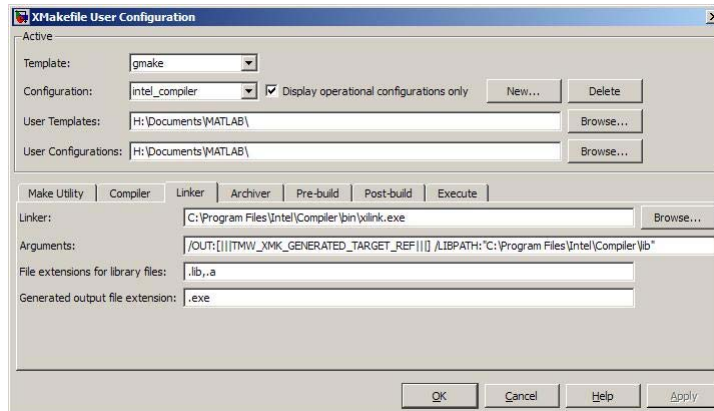

**Archiver.** For **Archiver**, enter the location of the archiver, `xilib.exe`. Confirm that **File extensions for library files** includes `.lib`.

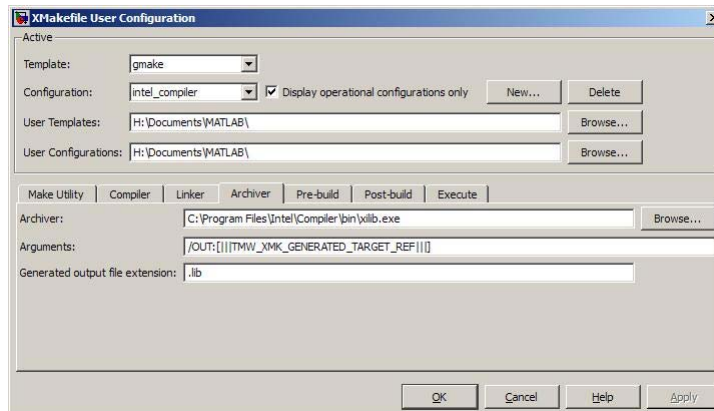

**Other tabs.** For this example, ignore the remaining tabs. In other circumstances, you can use them to configure additional build actions. In a later step of this example, you will configure the software to automatically build and run the generated code.

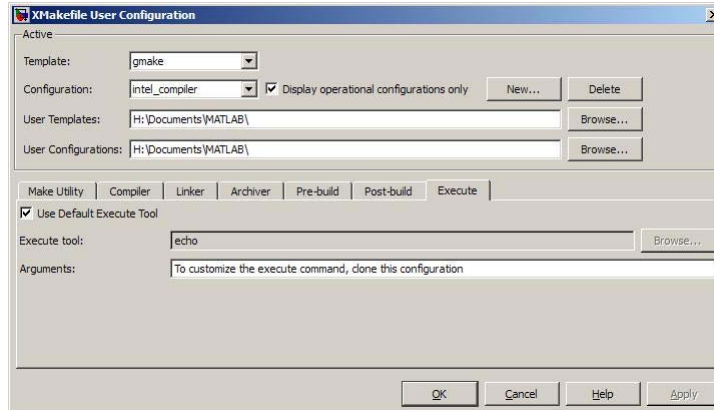

## Test the Configuration

Open the “sumdiff” model by entering `sumdiff` on the MATLAB prompt.

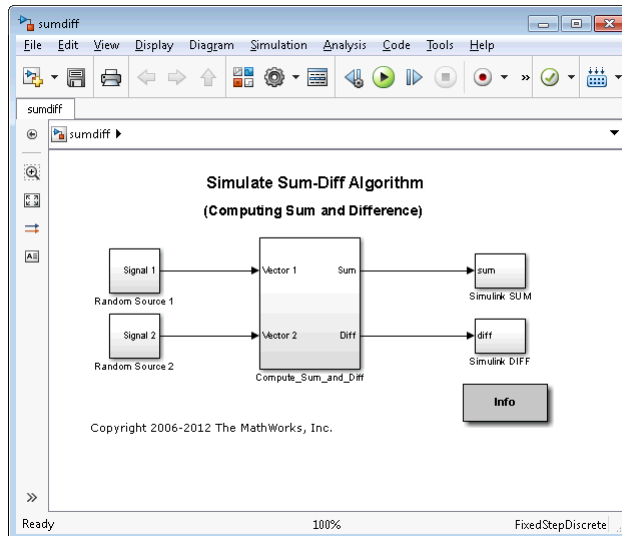

Use a Target Preferences block to configure the model for use with the Eclipse IDE. In the Simulink Library Browser, search for “Target Preferences”. Drag and drop the Target Preferences block from the search results to the `sumdiff` model.

Configure the Target Preferences block as follows: set **IDE/Tool Chain** to Eclipse, set **Board** to Custom, and set **Processor** to Intel x86/Pentium.

Open the Target Preferences block and set **Operating System** to None or select Windows. Click **OK**.

Open the Configuration Parameters for the sumdiff model by pressing **Ctrl+E**. Set **Build format** to Makefile and **Build action** to Build\_and\_execute.

Save the model to a temporary location, such as C:\Temp\IntelTest\.

Set that location as a Current Folder by typing `cd C:\temp\IntelTest\` at the MATLAB prompt.

Build the model by pressing **Ctrl+B**. The MATLAB Command Window displays something like:

```
### TLC code generation complete.
### Creating HTML report file sumdiff_codegen_rpt.html
### Creating project: c:\temp\IntelTest\sumdiff_eclipseide\sumdiff.mk
### Project creation done.
### Building project...
### Build done.
### Downloading program: c:\temp\IntelTest\sumdiff_eclipseide\sumdiff
### Download done.
```

A command window comes up showing the running model. Terminate the generated executable by pressing **Ctrl+C**.

## **XMakefile User Configuration Dialog Box**

- “Active” on page 25-32
- “Make Utility” on page 25-34
- “Compiler” on page 25-34
- “Linker” on page 25-35
- “Archiver” on page 25-35



Use the **Delete** button to delete a configuration you created.

---

**Note** You cannot edit or delete the configurations provided by MathWorks.

---

---

**Note** Use mapped network drives instead of UNC paths to specify directory locations. Using UNC paths with compilers that do not support them causes build errors.

---

**Display operational configurations only.** When you open the XMakefile User Configuration dialog box, the software verifies that each configuration provided by MathWorks contains valid paths to the executable files it uses. If all of the paths are valid, the configuration is operational. If any of the paths are not valid, the configuration is not operational.

This setting only affects configurations provided by MathWorks, not configurations you create.

To display valid configurations, select **Display operational configurations only**.

To display all of the configurations, including non-operational configurations, clear **Display operational configurations only**.

For more information, see “Making an XMakefile Configuration Operational” on page 25-24.

**User Templates.** Set the path of the folder to which you can add template files. Saving templates files with the .mkt extension to this folder adds them to the **Templates** options.

**User Configurations.** Set the location of configuration files you create with the **New** button.

## Make Utility

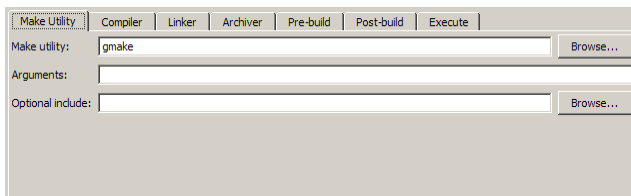

The screenshot shows the 'Make Utility' configuration dialog box. It has a title bar with tabs for 'Make Utility', 'Compiler', 'Linker', 'Archiver', 'Pre-build', 'Post-build', and 'Execute'. The 'Make Utility' tab is active. It contains three input fields: 'Make utility:' with the value 'gmake' and a 'Browse...' button; 'Arguments:' which is empty; and 'Optional include:' which is empty and also has a 'Browse...' button.

**Make utility.** Set the path and filename of the make utility executable.

**Arguments.** Define the command-line arguments to pass to the make utility. For more information, consult the third-party documentation for your make utility.

**Optional include.** Set the path and file name of an optional makefile to include.

## Compiler

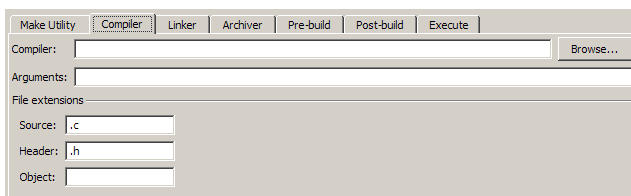

The screenshot shows the 'Compiler' configuration dialog box. It has a title bar with tabs for 'Make Utility', 'Compiler', 'Linker', 'Archiver', 'Pre-build', 'Post-build', and 'Execute'. The 'Compiler' tab is active. It contains three input fields: 'Compiler:' with a 'Browse...' button; 'Arguments:' which is empty; and 'File extensions:' which includes three sub-fields: 'Source:' with the value '.c', 'Header:' with the value '.h', and 'Object:' which is empty.

**Compiler.** Set the path and file name of the compiler executable.

**Arguments.** Define the command-line arguments to pass to the compiler. For more information, consult the third-party documentation for your compiler.

**Source.** Define the file name extension for the source files. Use commas to separate multiple file extensions.

**Header.** Define the file name extension for the header files. Use commas to separate multiple file extensions.

**Object.** Define the file name extension for the object files.

## Linker

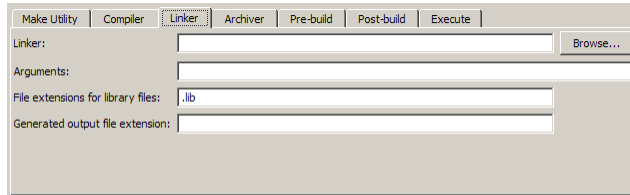

**Linker.** Set the path and file name of the linker executable.

**Arguments.** Define the command-line arguments to pass to the linker. For more information, consult the third-party documentation for your linker.

**File extensions for library files.** Define the file name extension for the file library files. Use commas to separate multiple file extensions.

**Generated output file extension.** Define the file name extension for the generated libraries or executables.

## Archiver

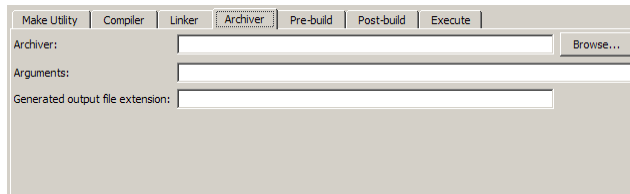

**Archiver.** Set the path and file name of the archiver executable.

**Arguments.** Define the command-line arguments to pass to the archiver. For more information, consult the third-party documentation for your archiver.

**Generated output file extension.** Define the file name extension for the generated libraries.

### Pre-build

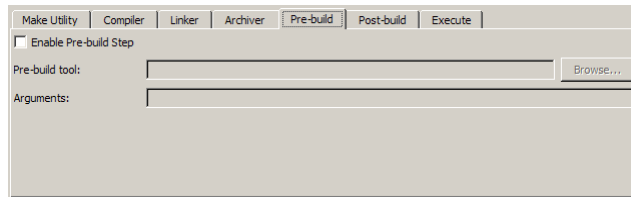

The screenshot shows a dialog box with a tabbed interface. The 'Pre-build' tab is selected. It contains a checkbox labeled 'Enable Pre-build Step'. Below it are two text input fields: 'Pre-build tool:' and 'Arguments:'. A 'Browse...' button is located to the right of the 'Pre-build tool:' field.

**Enable Prebuild Step.** Select this check box to define a prebuild tool that runs before the compiler.

**Prebuild tool.** Set the path and file name of the prebuild tool executable.

**Arguments.** Define the command-line arguments to pass to the prebuild tool. For more information, consult the third-party documentation for your prebuild tool.

### Post-build

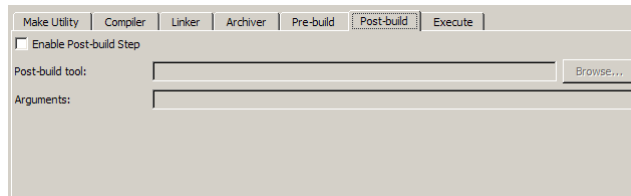

The screenshot shows a dialog box with a tabbed interface. The 'Post-build' tab is selected. It contains a checkbox labeled 'Enable Post-build Step'. Below it are two text input fields: 'Post-build tool:' and 'Arguments:'. A 'Browse...' button is located to the right of the 'Post-build tool:' field.

**Enable Postbuild Step.** Select this check box to define a postbuild tool that runs after the compiler or linker.

**Postbuild tool.** Set the path and file name of the postbuild tool executable.

**Arguments.** Define the command-line arguments to pass to the postbuild tool. For more information, consult the third-party documentation for your postbuild tool.



## Execute

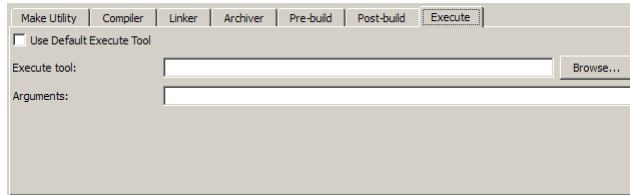

**Use Default Execute Tool.** Select this check box to use the generated derivative as the execute tool when the build process is complete. Uncheck it to specify a different tool. The default value, `echo`, simply displays a message that the build process is complete.

---

**Note** On the Linux operating system, multirate multitasking executables require root privileges to schedule POSIX threads with real-time priority. If you are using makefiles to build multirate multitasking executables on your Linux development system, you cannot use **Execute tool** to run the executable. Instead, use the Linux command, `sudo`, to run the executable.

---

**Execute tool.** Set the path and file name of the execute tool executable or built-in command.

**Arguments.** Define the command-line arguments to pass to the execute tool. For more information, consult the third-party documentation for your execute tool.

## Tool Directories

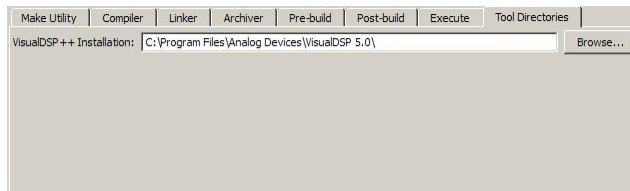

**Installation.** Use the Tool Directories tab to change the toolchain path of an operational configuration.

For example, if you installed two versions of a vendor build tool in separate folders, you can use the **Installation** path to change which one the configuration uses.

# Verification Code Generated for Desktop Targets

---

Verify and profile generated code executing on processors

## Processor-in-the-Loop (PIL) Simulation

### In this section...

“Overview” on page 26-2

“PIL Approaches” on page 26-3

“Communications” on page 26-8

“Running Your PIL Application to Perform Simulation and Verification” on page 26-11

“Definitions” on page 26-11

“PIL Issues and Limitations” on page 26-12

### Overview

Processor-in-the-loop (PIL) requires an Embedded Coder license.

Verification consists broadly of running generated code on a processor and verifying that the code does what you intend. Embedded Coder provides processor-in-the-loop (PIL) simulation to meet this need. PIL compares the numeric output of your model under simulation with the numeric output of your model running as an executable on a target processor.

With PIL, you run your generated code on a target processor or instruction set simulator. To verify your generated code, you compare the output of model simulation modes, such as Normal or Accelerator, with the output of the generated code running on the processor. You can switch between simulation and PIL modes. This flexibility allows you to verify the generated code by executing the model as compiled code in the target environment. You can model and test your embedded software component in Simulink and then reuse your regression test suites across simulation and compiled object code. This process avoids the time-consuming process of leaving the Simulink software environment to run tests again on object code compiled for the production hardware.

Embedded Coder supports the following PIL approaches:

- Model block PIL

- Top-model PIL
- PIL block

When you use makefiles with PIL, use the “model block PIL” approach. With makefiles, the other two approaches, “top-model PIL” and “PIL block”, and are not supported.

Processor-in-the-loop (PIL) builds and uses a MEX function to run the PIL simulation block. Before using PIL, set up a compiler for MATLAB to build the MEX files. Run the command `| mex -setup |` to select a compiler configuration. For more information, read “Build MEX-Files”

## PIL Approaches

### Model Block PIL

Use model block PIL to:

- Verify code generated for referenced models (model reference code interface).
- Provide a test harness model (or a system model) to generate test vector or stimulus inputs.
- Switch a model block between normal, SIL, or PIL simulation modes.

To perform a model block PIL simulation, start with a top-model that contains a model block. The top-model serves as a test harness, providing inputs and outputs for the model block. The model block references the model you plan to run on a target processor. During PIL simulation, the referenced model runs on the target processor.

For more information about using the model block, see Model Variants and “Model Reference”.

By default, your MathWorks software uses the IDE debugger for PIL communications with the target processor. To achieve faster communications, consider using one alternatives presented in “Communications” on page 26-8.

To use model block PIL:

- 1 Right-click the Model block, and select **ModelReference Parameters**.
- 2 When the software displays the **Function Block Parameters: Model** dialog box, set **Simulation mode** to Processor-in-the-loop (PIL) and click **OK**.
- 3 Open the model block.
- 4 Add a Target Preferences block to either model, and configure it for the target processor.
- 5 Copy the Target Preferences block from one model to the other. The top-model and the model block now contain identical Target Preference blocks.
- 6 In the referenced model (model block) Configuration Parameters (**Ctrl+E**), under **Code Generation > IDE Link**, set **Build action** set to `Archive_library`. This action avoids a warning when you start the simulation.
- 7 Save the changes to both models.
- 8 In the top-model menu bar, select **Simulation > Run**. This action builds the referenced model in the model block, downloads it to your target processor, and runs the PIL simulation.

---

**Note** In the top-model Configuration Parameters (**Ctrl+E**), under **Code Generation > IDE Link**, leave **Build action** set to `Build_and_execute`. Do not change **Build action** to `Create_Processor_In_the_Loop_Project`.

---

### Top-Model PIL

Use top-model PIL to:

- Verify code generated for a top-model (standalone code interface).
- Load test vectors or stimulus inputs from the MATLAB workspace.
- Switch the entire model between normal and SIL or PIL simulation modes.

### Setting Model Configuration Parameters to Generate the PIL

**Application.** Configure your model to generate the PIL executable from your model:

- 1 Add a Target Preferences block in to your model. The Target Preferences block is located in the Simulink library browser under Simulink Coder > Desktop Targets.
- 2 Open the Target Preferences block and select your processor from the list of processors.
- 3 From the model toolstrip, select **Simulation > Model Configuration Parameters**.
- 4 In Configuration Parameters, select **Code Generation**.
- 5 Set **System Target File** to `idmlink_ert.tlc`.
- 6 From the list of panes under **Code Generation**, choose **IDE Link**.
- 7 Set **Build format** to Project.
- 8 Set **Build action** to `Create_processor_in_the_loop_project`.
- 9 Click **OK** to close the Configuration Parameters dialog box.

For more information, see “Code Generation Pane: IDE Link”.

**Running the Top-Model PIL Application.** To create a PIL block, perform the following steps:

- 1 In the model toolstrip, set the Simulation mode to Processor-in-the-loop.

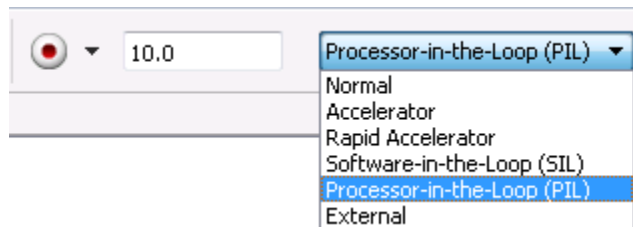

- 
- 2** In the model toolstrip, click **Run**



A new Simulink Editor opens with the new PIL model block in it. The third-party IDE compiles and links the PIL executable file. Follow the progress of the build process in the MATLAB command window.

### **PIL Block**

Use the PIL block to:

- Verify code generated for a top-model (standalone code interface) or subsystem (right-click build standalone code interface).
- Represent a component running in SIL or PIL mode. The test harness model or a system model provides test vector or stimulus inputs.

**Preparing Your Model to Generate a PIL Block.** Start with a model that contains the algorithm blocks you want to verify on the processor as compiled object code. To create a PIL application and PIL block from your algorithm subsystem, follow these steps:

- 1** Identify the algorithm blocks to cosimulate.
- 2** Convert those blocks into an unmasked subsystem in your model.

For information about how to convert your process to a subsystem, refer to *Creating Subsystems* in *Using Simulink* or in the online Help system.

- 
- 
- 3** Open the newly created subsystem and copy a Target Preferences block to it. The Target Preferences block is located in the Simulink library browser under Simulink Coder > Desktop Targets.

Open the Target Preferences block and select your processor from the list of processors.



**Setting Model Configuration Parameters to Generate the PIL Application.** After you create your subsystem, set the Configuration Parameters for your model to enable the model to generate a PIL block.

Configure your model to enable it to generate PIL algorithm code and a PIL block from your subsystem:

- 1** From the model menu bar, select **Simulation > Model Configuration Parameters**. This action opens the Configuration Parameters dialog box.
- 2** In the Configuration Parameters dialog box, select **Code Generation**.
- 3** Set **System Target File** to `idmlink_ert.tlc`.
- 4** From the list of panes under **Code Generation**, choose **IDE Link**.
- 5** Set **Build format** to **Project**.
- 6** Set **Build action** to `Create_processor_in_the_loop_project`.
- 7** Click **OK** to close the Configuration Parameters dialog box.

For more information, see “Code Generation Pane: IDE Link”.

**Creating the PIL Block from a Subsystem.** To create a PIL block, perform the following steps:

- 1** Right-click the masked subsystem in your model and select **C/C++ Code > Build This Subsystem** from the context menu.

A new Simulink Editor opens and the new PIL block appears in it. The third-party IDE compiles and links the PIL executable file.

This step builds the PIL algorithm object code and a PIL block that corresponds to the subsystem, with the same inputs and outputs. Follow the progress of the build process in the MATLAB command window.

- 2** Copy the new PIL block from the new model to your model. To simulate the subsystem processes concurrently, place it parallel to your masked subsystem. Otherwise, replace the subsystem with the PIL block.

To see a PIL block in a parallel masked subsystem, search the product help for *Getting Started with Application Development* and select the example that matches your IDE.

---

**Note** Models can have multiple PIL blocks for different subsystems. They cannot have more than one PIL block for the same subsystem. Including multiple PIL blocks for the same subsystem causes errors and inaccurate results.

---

## Communications

- “TCP/IP” on page 26-9
- “IDE Debugger” on page 26-10

Chose one of the following communication methods for transferring code and data during PIL simulations:

Method	Speed	Comments
IDE Debugger	Slow	<ul style="list-style-type: none"> <li>• Supports PIL communications with an executable running an embedded target processor.</li> </ul>
TCP/IP	Fast	<ul style="list-style-type: none"> <li>• Supports PIL communications with an executable running on a Linux or Windows host.</li> <li>• Supports embedded targets running Linux, TI DSP/BIOS, and Wind River VxWorks.</li> <li>• Requires network connection between host and target processor.</li> <li>• Works with builds from IDE projects and from makefiles.</li> </ul>
Serial Communication Interface (SCI)	Fast	<ul style="list-style-type: none"> <li>• Supports PIL communications with an executable running an embedded target processor.</li> </ul>

Method	Speed	Comments
		<ul style="list-style-type: none"> <li>• Supports only TI C28035 and C28335 microcontrollers.</li> <li>• Requires an SCI connection between host and target processor.</li> <li>• Works with builds from IDE projects and from makefiles.</li> </ul>

## TCP/IP

You can use TCP/IP for PIL communications with a hardware target running:

- Linux
- Microsoft Windows

Using TCP/IP for PIL communications is typically faster than using a debugger, particularly for large data sets, such as with video and audio applications.

You can use TCP/IP with the following PIL approaches:

- Top-model PIL
- Model block PIL

TCP/IP does not work with the Subsystem PIL approach.

To enable and configure TCP/IP with PIL:

- 1 Set up a PIL simulation according to the PIL approach you have chosen.
- 2 In the MATLAB Command Window, use `setpref` to specify the IP address of the PIL server (`servername`).

If you are running the PIL server on a remote target, specify the IP address of the target processor. For example:

```
setpref('MathWorks_Embedded_IDE_Link_PIL_Preferences', 'servername', '144.212.109.114');
```

If you are running PIL server locally, on your host Windows or Linux system, enter 'localhost' instead of an IP address:

```
setpref('MathWorks_Embedded_IDE_Link_PIL_Preferences','servername','localhost');
```

- 3 Specify the TCP/IP port number to use for PIL data communication. Use one of the free ports in your system. For example:

```
setpref('MathWorks_Embedded_IDE_Link_PIL_Preferences','portnum', 17025);
```

- 4 Enable PIL communications over TCP/IP:

```
setpref('MathWorks_Embedded_IDE_Link_PIL_Preferences','enabletcpip', true);
```

To disable PIL communications over TCP/IP, change the value to `false`. This action automatically enables PIL communications over an IDE debugger, if an IDE is available.

- 5 Open the Target Preferences block in your model, then set the **Operating System** parameter to an operating system.

---

**Note** You cannot use TCP/IP for PIL when the value of **Operating System** is None.

---

- 6 Regenerate the code or PIL block.

To disable PIL communications over TCP/IP, enter:

```
setpref('MathWorks_Embedded_IDE_Link_PIL_Preferences','enabletcpip', false);
```

## IDE Debugger

To enable PIL communications over an IDE debugger, disable PIL communications over TCP/IP and SCI by entering the following commands:

```
setpref('MathWorks_Embedded_IDE_Link_PIL_Preferences','enabletcpip',false);  
setpref('MathWorks_Embedded_IDE_Link_PIL_Preferences','enableserial',false);
```

Then regenerate the code or PIL block.

Using IDE debugger for PIL communication only works when you build your code from IDE projects. Using IDE debugger for PIL communication does not work with builds from makefiles.

## Running Your PIL Application to Perform Simulation and Verification

After you add your PIL block to your model, click **Simulation > Run** or press **Ctrl+T** to run the PIL simulation and view the results.

### Definitions

#### PIL Algorithm

The algorithmic code, which corresponds to a subsystem or portion of a model, to test during the PIL simulation. The PIL algorithm is in compiled object form to enable verification at the object level.

#### PIL Application

The executable application that runs on the processor platform. Your coder product creates a PIL application by augmenting your algorithmic code with the PIL execution framework. The PIL execution framework code compiles as part of your embedded application.

The PIL execution framework code includes the `string.h` header file so that the PIL application can use the `memcpy` function. The PIL application uses `memcpy` to exchange data between the Simulink model and the simulation processor.

#### PIL Block

When you build a subsystem from a model for PIL, the process creates a PIL block optimized for PIL simulation. When you run the simulation, the PIL block acts as the interface between the model and the PIL application running on the processor. The PIL block inherits the signal names and shape from the source subsystem in your model. Inheritance is convenient for copying the PIL block into the model to replace the original subsystem for simulation.

### **PIL Issues and Limitations**

Consider the following issues when you work with PIL blocks.

#### **Constraints**

When using PIL in your models, keep the following constraints in mind:

- Models can have multiple PIL blocks for different subsystems. They cannot have more than one PIL block for the same subsystem. Including multiple PIL blocks for the same subsystem causes errors and inaccurate results.
- A model can contain a single model block running PIL mode.
- A model can contain a subsystem PIL block or a model block in PIL mode, but not both.

#### **Generic PIL Issues**

Refer to PIL Feature Support and Limitations for general information about using the PIL block with embedded link products.

#### **Simulink Coder grt.tlc-Based Targets Not Supported**

PIL does not support `grt.tlc` system target files.

To use PIL, set **System target file** in the Configuration Parameters > Code Generation pane to `idmlink_ert.tlc`.

# Working with Eclipse IDE

---

- “Installing Third-Party Software for Eclipse” on page 27-2
- “Configuring Your MathWorks Software to Work with Eclipse” on page 27-10
- “Troubleshooting with Eclipse IDE” on page 27-14

---

**Note** To use the coder product with Eclipse IDE, complete the steps in “Installing Third-Party Software for Eclipse” on page 27-2 and “Configuring Your MathWorks Software to Work with Eclipse” on page 27-10

---

## Installing Third-Party Software for Eclipse

In this section...
“Tested Software Versions” on page 27-2
“Installing Sun Java Runtime Environment (JRE)” on page 27-3
“Installing Eclipse IDE for C/C++ Developers” on page 27-5
“Verifying the GNU Tool Chain on Linux Host” on page 27-6
“Installing the GNU Tool Chain on Windows” on page 27-7

### Tested Software Versions

MathWorks has tested the coder product with the specific software versions listed in the following tables.

Required for all platforms	Tested Versions
Sun™ Java™ Runtime Environment (JRE)	JRE 6.0 (Java 1.6.x)
Eclipse IDE for C/C++ Developers package, which includes the CDT feature	Ganymede (Eclipse 3.4)
CDT (If CDT is installed separately from Eclipse IDE for C/C++ Developers package, match CDT version with Eclipse version.)	CDT 5.0

Linux: Additional Software Required	Tested Versions
GNU GCC (compiler)	GCC 4.4
GNU as (assembler — part of the GNU binutils package)	as 2.18



Linux: Additional Software Required	Tested Versions
GNU ar (archiver — part of the GNU binutils package)	ar 2.18
GNU GDB (debugger)	GDB 6.8.x
GNU make	make 3.81

Windows: Additional Software Required	Tested Versions
MinGW	5.1.x
GDB	GDB 6.3.x
MSYS	1.0.11

You can try untested versions and combinations of third-party software at your own risk.

For the most current information about using the coder product software with Eclipse IDE, see: [www.mathworks.com/products/simulink-coder/eclipse-adaptor.html](http://www.mathworks.com/products/simulink-coder/eclipse-adaptor.html)

## Installing Sun Java Runtime Environment (JRE)

To install the JRE, complete the following steps:

- 1 At your Windows or Linux command prompt, enter:

```
java -version
```

If Java is present, the command line responds with the version information, as this example shows.

```
$ java -version
java version "1.6.0_17"
Java(TM) SE Runtime Environment (build 1.6.0_17-b04)
$
```

- 2 If Java is missing or the version is lower than 1.6.x, download and install JRE 6.0 from <http://www.java.com>.

**3** Get the path of the Java JRE by entering `which java` on the command line.

**4** Set the PATH system variable in your operating system.

For example, in Windows 7:

- a** Press the Windows key and search for “System environment variables” and open “Edit the system environment variables”.
- b** In System Properties, to go **Advanced** and click **Environment Variables**.
- c** In the **System variables**, locate and select “Path”.
- d** Click the **Edit** button and add the path of the Java JRE to the **Variable value**.

For example , add `C:\Program Files\Java\jre6\bin;` to the **Variable value**.

- e** Click OK to save your changes.

For example, with Linux:

- a** Open a startup file, such as `~/ .cshrc`.
- b** Add the path of the Java JRE to the PATH variable.

For example, on a 64-bit Linux host computer, if you are using `csch` or `tcsh`, enter:

```
setenv PATH $PATH:/local/MATLAB/R2011b/sys/java/jre/glnxa64/jre/bin
```

For example, on a 64-bit Linux host computer, if you are using `sh`, `ksh`, or `bash`, enter:

```
PATH=$PATH:/local/MATLAB/R2011b/sys/java/jre/glnxa64/jre/bin ; export PATH
```

- c** Save your changes and close the file.

For more information, see <http://www.java.com/en/download/help/path.xml>.

**5** Verify that Java is working by entering `java -version` again or by visiting <http://www.java.com/en/download/help/testvm.xml>.

---

## Installing Eclipse IDE for C/C++ Developers

---

**Note** The following instructions are based on Eclipse 3.4 (Ganymede). More recent versions of the Eclipse IDE can have different appearances, menus, or software package names.

---

The Eclipse IDE for C/C++ Developers package includes the Eclipse IDE and the C/C++ Development Tools (CDT). To install Eclipse IDE for C/C++ Developers package, complete the following steps:

- 1** Download the Ganymede SR2 zip file for Eclipse IDE for C/C++ Developers, from <http://www.eclipse.org/downloads/packages/release/ganymede/sr2>.
- 2** Extract the Eclipse files to a permanent location, such as `C:\eclipse\` and create a desktop shortcut to `eclipse.exe`.
- 3** Start Eclipse, and select **Help > Software Updates**.
- 4** Look under the **Installed Software** tab, and verify that Eclipse has the following three CDT software packages.
  - Eclipse C/C++ Development Platform
  - Eclipse C/C++ Development Tools
  - Mylin Bridge: C/C++ Development

If you have a previous Eclipse installation that does not include CDT, complete the following steps:

- 1** In Eclipse, select **Help > Software Updates**.
- 2** Click the **Available Software** tab.
- 3** Click **Ganymede Update Site**.
- 4** Select **C and C++ Development**, and click **Install**.
- 5** When the installation process completes, click the **Installed Software** tab, and verify that you have CDT.

## Verifying the GNU Tool Chain on Linux Host

Most Linux distributions include the following GNU C/C++ development tools. Eclipse and CDT require these tools to compile code, build projects, and debug applications:

- Assembler (as)
- Archiver (ar)
- compiler and linker (gcc)
- debugger (gdb)
- build utility (make)

Verify that the GNU tools are present and set the tool chain path:

**1** On the Linux command line, enter:

- `gcc --version`
- `gdb --version`
- `as --version`
- `ar --version`
- `make --version`

**2** Compare the version of each tool with the following list of tested versions:

- gcc 4.4
- as 2.18
- ar 2.18
- gdb 6.8.x
- make 3.81

If you are using Eclipse for targeting embedded Linux, disregard the version numbers in the preceding list.

To install a missing tool or to change the version of the tool, use the software installation manager that comes with your Linux distribution.

Alternatively, visit <http://directory.fsf.org/GNU/> for more information about individual tools. Source files for the tools are available from:

- binutils (includes `as` and `ar`), <http://ftp.gnu.org/gnu/binutils/>
- gcc, <http://ftp.gnu.org/gnu/gcc/>
- gdb, <http://ftp.gnu.org/gnu/gdb/>
- make, <http://ftp.gnu.org/gnu/make/>

- 3** Modify the `PATH` environment using the right commands for your running shell. You can also modify the path environment variable in your login scripts.

If you are using a Bash shell prompt, enter:

```
PATH=my_tool_path:$PATH
```

Where `my_tool_path` is the path to the GNU tool binaries. For example:

```
PATH=/bin:$PATH
```

If you are using a C shell prompt, enter:

```
setenv PATH my_tool_path:$PATH
```

Where `my_tool_path` is the path to the GNU tool binaries. For example:

```
setenv PATH /bin:$PATH
```

## Installing the GNU Tool Chain on Windows

Windows typically does not include GNU C/C++ development tools. Eclipse and CDT require these tools to compile code, build projects, and debug applications.

Provide a GNU tool chain for Windows by installing MinGW:

- 1** Open <http://sourceforge.net/projects/mingw/files/>.
- 2** Download and run the latest version of the “Automated MinGW Installer”.

---

**Note** The earliest version of MinGW available is more recent than the tested version.

---

- 3** Start the MinGW installation wizard to perform a default installation.

Perform a default installation until you reach **Select Components**. At that step, select **MSYS Basic System**.

Then, complete the default installation process. Wait for the installation wizard to download, and install additional files from the Internet.

---

**Note** If you alter the default installation path, C:/MinGW, do not use spaces in the new path.

---

Set the PATH environment variable:

- 1** In Windows, right-click **My Computer** or **Computer**, and choose **Properties**.
- 2** Then select **Advanced** or **Advanced system settings**, and click **Environment Variables**.
- 3** Under **System variables**, scroll down to the **Path** variable.
- 4** Select **Path**, and click **Edit**.
- 5** Configure the operating system to the GNU tools when there are multiple paths:
  - a** Add the paths of the MinGW and MSYS bin folders to the beginning of the **Variable value**.
  - b** Use semicolons to separate the paths. For example,  
C:\mingw\bin;C:\mingw\msys\1.0\bin;

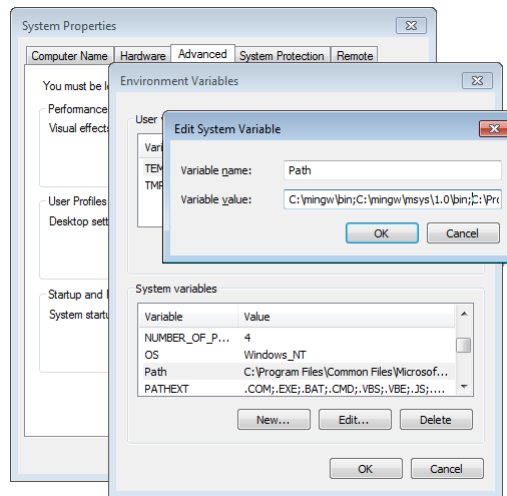

6 To verify the GNU tools installation and path settings, enter the following commands on the Windows command line:

- `gcc --version`
- `gdb --version`
- `as --version`
- `ar --version`
- `make --version`

Each command displays the tool name and version on the command line. If you receive a message that the command is not recognized, verify that you completed the preceding installation and path configuration instructions.

You can use versions of the GNU tools that are more recent than the tested versions at your own risk.

## Configuring Your MathWorks Software to Work with Eclipse

After you install the third-party software, configure the coder product to work with Eclipse:

- 1 Close Eclipse IDE before you run `eclipseidesetup`. For more information, see “Build Errors” on page 27-15.
- 2 in the MATLAB Command Window, enter `eclipseidesetup`. The coder product opens the “IDE Link: Eclipse Adaptor Setup” dialog box, as shown here on Windows:

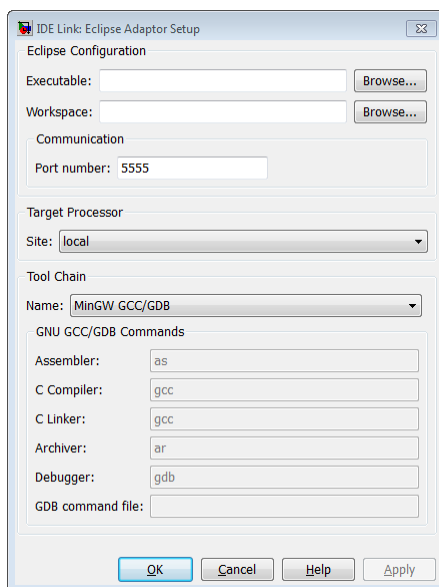

---

**Note** On Linux, the “IDE Link: Eclipse Adaptor Setup” dialog box shows different options than on Windows

---

- 3 Update **Executable** with the location and file name of the Eclipse application file. For example, `C:\eclipse\eclipse.exe`.



You can get this value by right-clicking a shortcut for Eclipse and looking at the properties.

- 4 Update **Workspace** with the default location where Eclipse creates and saves new project files. For example, `C:\WINNT\Profiles\username\workspace`.

To find the current workspace, open Eclipse and select **File > Switch Workspace > Other**.

In the future, if you change the Eclipse workspace, repeat this configuration procedure.

Do not use workspace paths that contain spaces. If you have a path with spaces, recreate the workspace, and then update the path in Eclipse.

- 5 For **Port number**, enter a valid, unused, IP port number. For example, `5555`.
- 6 For **Site**, identify where the coder product uploads and runs the executable file upon completing the build process. Use either of these options:

- Choose `local` to run the executable on your Linux or Windows workstation.

This option requires the Simulink Coder product.

- Choose `remote` to download the executable to a remote target running Linux operating system over a network connection (for example, to connect to an embedded system connection to the Ethernet port on your workstation).

This option requires the Embedded Coder product.

You must perform additional steps to connect to a remote target running Linux. See .

---

**Note** Later on, when you are working on your model, open the Target Preferences block, and set **Processor** to match the processor at the **Site** you selected.

---

**7** To customize the Tool Chain settings, see the **Custom GCC/GDB** topic.

**8** When you click **OK** or **Apply**, the coder product:

- Verifies the locations of the Executable and Workspace in the Eclipse Adaptor Setup dialog box.
- Verifies that the required third-party software is present.
- Installs the coder product plug-ins in the Eclipse plugins folder. For example, in C:\Program Files\eclipse\plugins\.
- Saves configuration information to the `mwidelink.ini` file, located in the Eclipse plugins folder.

---

**Note** When Eclipse starts, it loads the coder product plug-in. The coder product plug-in loads the port number from `mwidelink.ini`. To resolve a port number conflict, change the port number by running `eclipseidesetup` again. Do not edit `mwidelink.ini`.

---

**9** To verify that the configuration process is complete, create a handle object for the Eclipse IDE. Enter the following command in MATLAB

```
IDE_Obj = eclipseide
```

This command, starts Eclipse IDE if it is not already running, and creates a handle object. For example:

```
Starting Eclipse(TM) IDE...
```

```
ECLIPSEIDE Object:
  Default timeout : 10.00 secs
  Eclipse folder  : C:\eclipse3.4\eclipse
  Eclipse workspace: C:\WINNT\Profiles\rolfedh\workspace
  Port number     : 5555
  Processor site  : local
```

If you are using more recent versions of the GNU tools, you can disregard command-line warnings about using untested versions.

**10** In Eclipse, click the following icon to see the status of the IDE Link plug-in.

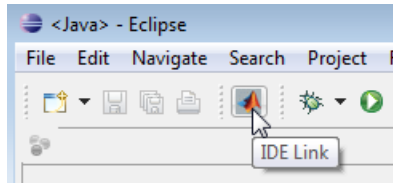

## Troubleshooting with Eclipse IDE

### In this section...

“SIGSEGV Segmentation Fault for GDB” on page 27-14

“GDB Stops on Each Semaphore Post” on page 27-14

“Build Errors” on page 27-15

“Profiling Not Available for Intel x86/Pentium and AMD K5/K6/Athlon Processors Running Windows or Linux Operating Systems” on page 27-15

“Eclipse Message: “Can’t find a source file”” on page 27-15

“Eclipse Message: “Cannot access memory at address”” on page 27-16

“Some Versions of Eclipse CDT Do Not Catch GCC Errors” on page 27-16

### SIGSEGV Segmentation Fault for GDB

If you use Comodo Internet Security (CIS) software on your development system, CIS causes a SIGSEGV segmentation fault for GDB. When this fault occurs, you receive the following message:

```
Debugger name and version: GNU gdb (GDB) 7.0
Program received signal SIGSEGV, Segmentation fault.
In ntdll!RtlpWaitForCriticalSection () (C:\WINDOWS\system32\ntdll.dll)
Continuing...
Program received signal SIGSEGV, Segmentation fault.
In ?? () (C:\WINDOWS\system32\guard32.dll)
```

If you get this message, click **OK** and then click **Continue**.

For more information, see the “Guard32.dll causes SIGSEGV segmentation fault for GDB debugger CIS 3.9.95478 x32” topic at <http://forums.comodo.com/>.

### GDB Stops on Each Semaphore Post

If you use gdb to debug a target application running on Linux or Windows, gdb stops on each semaphore post. You can override this expected behavior adding the following text to `.gdbinit`, the GDB init file:

```
handle SIG34 nostop noprint pass
handle SIG35 nostop noprint pass
```

On Linux, `.gdbinit` resides on your home folder, by default. On Windows, the environment variable `HOME` defines the home folder. For more information about creating `.gdbinit` and configuring `gdb`, consult the *GDB User Manual*, available from <http://www.gnu.org/software/gdb/documentation/>.

## Build Errors

If you use `eclipseidesetup` without closing Eclipse IDE, you may get build errors similar to the following ones:

```
The call to idelink_ert_make_rtw_hook, during the exit hook generated the following error:
Error while creating the project.
```

```
The build process will terminate as a result.
```

```
===
```

```
Error while creating the project.
```

```
===
```

```
Error creating a new project.
```

```
===
```

```
An exception occurred while performing this operation. 0
```

To solve this problem, close and restart Eclipse IDE.

## Profiling Not Available for Intel x86/Pentium and AMD K5/K6/Athlon Processors Running Windows or Linux Operating Systems

Profiling is not available for Intel x86/Pentium and AMD K5/K6/Athlon processors running Windows or Linux.

## Eclipse Message: “Can’t find a source file”

With specific Configuration Parameters, while building and loading a target application, Eclipse IDE displays a message that it could not find a source file. This message appears even if the load action completes. Here is an example of the message:

```
Can't find a source file at
"../../sumdiff_bash_eclipseide/sumdiff_bash_main.c
Locate the file or edit the source lookup path
to include its location.
```

In Configuration Parameters, on the IDE Link pane, in the Vendor Tool Chain section: If **Configuration** is set to Release or Custom, the coder product does not specify the `-g` compiler option for gcc. Therefore, the build process does not produce debugging information gdb requires. Without this information, gdb cannot map the executable to the source file, resulting in the "Can't find a source file" message.

To solve this problem, add `-g` to the **Compiler options string** for the Custom and Release configurations, or set **Configuration** to Debug.

## **Eclipse Message: "Cannot access memory at address"**

If you use the coder product's halt method to stop the target application, Eclipse displays a message similar to the following example:

```
[Switching to thread 5528.0x1664]
Quit (expect signal SIGINT when the program is resumed)
Cannot access memory at address 0x720000
Cannot access memory at address 0x720000
```

This error is not related to Eclipse IDE. It is a bug with gdb/MinGW. It typically occurs when gdb tries to access an invalid or protected memory location.

## **Some Versions of Eclipse CDT Do Not Catch GCC Errors**

If you set a bad compiler flag, specific versions of Eclipse CDT prior to version 7.0.2 fail to catch gcc errors that the flag is wrong.

To reproduce this problem:

- 1 Open a project and select **C/C++ Build > Tool Chain Editor**.

- 2** Set **Current builder** to CDT Internal Builder.
- 3** Select **Project properties > C/C++ Build > Settings**.
- 4** Set **GCC C Compiler: Miscellaneous** to -D.
- 5** Build the project. Notice that gcc displays the following error while the Problems tab for the Eclipse IDE project does not display any errors:

```
<command-line>: error: macro names must be identifiers
```





# Working with Linux Target

---

- “Disambiguation” on page 28-2
- “Preparing Models to Run on Linux Target” on page 28-3
- “Scheduler” on page 28-4

## Disambiguation

This documentation uses the term “Linux” generically to refer to:

- Linux running on a host computer
- Linux running on an target processor

If the distinction between host and target is important, the documentation will identify the hardware platform on which Linux is running. For example:

- “Embedded Linux” or “Linux running on a target processor”
- “Linux running on a host computer.”

## Preparing Models to Run on Linux Target

To build an executable that runs on Linux, perform the following steps:

- 1** Install and configure Eclipse IDE according to the instructions in “Working with Eclipse IDE”.
- 2** Locate the Target Preferences block in the Simulink Library Browser, under Simulink Coder > Desktop Targets.
- 3** Copy the Target Preferences block to your model.
- 4** In the **Initialize Configuration Parameters** dialog box, set the IDE to Eclipse, and select the processor for which you are generating code.
- 5** Set **Operating System** to Linux. This action creates a **Linux** tab for setting the **Scheduling Mode** and **Base Rate Priority**.
- 6** Set the **Scheduling Mode** to one of these options:
  - If you select **real-time**, the model uses a timer to trigger the base rate at regular periods.
  - If you select **free-running**, the model does not use a timer. Instead, the model completes each process or thread before running the next one.
- 7** For Linux, you can set the **Base Rate Priority** relative to other processes and threads. You can enter values from (the number of rates + 1) to 99.
- 8** In IDE Link, configure the model to build and execute:
  - a** In the model, select **Simulation > Model Configuration Parameters**.
  - b** Under **Code Generation**, select the **IDE Link** pane.
  - c** Set **Build action** to **Build and execute**.
- 9** Click **Build Model**  on the model toolstrip.

After the build completes, Embedded Coder software downloads the executable to the remote system and runs it.

## Scheduler

### In this section...

“Base Rate” on page 28-4

“Running Target Applications on Multicore Processors” on page 29-4

“Running Multirate, Multitasking Executables on the Linux Desktop” on page 28-11

“Avoiding Lock-Up in Free-Running, Multirate, Multitasking Models” on page 28-12

### Base Rate

The base rate in the model maps to a thread and runs as fast as possible. The base rate priority selection in the OS tab allows you to set a static priority for the base rate task. By default, this rate is 40.

The process running single-tasking models has Default scheduling policy when model is single-tasking or there is a single rate in the model. Static priority of the process is 0 in this case.

## Running Target Applications on Multicore Processors

### Introduction

This section provides a variation of the process described in “Build and Download to a Multicore Target”.

This section shows you how to:

- Configure a multirate model
- Generate a multithreaded application from that model

So that the resulting application is enabled for concurrent multicore execution on a desktop target running Linux or Windows.

This process uses the `idelink_ert.tlc` or `idelink_grt.tlc` system target files, which enable you to:

- Use Eclipse IDE to manage projects for Linux and Windows targets (Support for this capability is only available on 32-bit host platforms)
- Set thread priority using a Target Preference block

## Looking at a Model

Before setting up your own model, consider the `sldemo_concurrent_execution` example model, which is referenced by “Build and Download to a Multicore Target”.

The `sldemo_concurrent_execution` model is a useful example to look at because:

- The model is partitioned using Model blocks that can potentially execute concurrently.
- You can look at the **Map Blocks To Tasks** pane in the Concurrent Execution window to see how the tasks are configured for concurrent execution.

However, you cannot run an unmodified version of the `sldemo_concurrent_execution` model on a desktop target running Linux or Windows.

To prepare the `sldemo_concurrent_execution` as an example model for the “Setting Up the Model” on page 29-7 and “Deploying the Model to Your Target” on page 29-8 topics, first perform the following modifications:

- Update the Plant Model Block
- Update the Compensator Model Block
- Verify that Models are Mapped

These procedures guide you through the processes of discretizing models and matching sample times of blocks with models.

### **Update the Plant Model Block.**

- 1** In the `sldemo_concurrent_execution` model, open the “Plant” Model block: `sldemo_concurrent_execution_plant`
- 2** Discretize the Plant model. Replace the Integrator blocks, “x1” and “x2”, with equivalent discrete time blocks (such as the Discrete Time Integrator block) or use the “Model Discretizer”.
- 3** Prevent modeling constraints by matching the sample time of the “x1” and “x2” blocks with the model: Open the “x1” and “x2” blocks and change the **Sample time** parameters to 0.1. Matching the sample times to the model can also be accomplished using Rate Transition blocks.
- 4** Convert blocks with continuous sample times (**Sample time** = 0) to inherited sample times (**Sample time** = -1). Open the “u1”, “u2” and “x” blocks. For each one, click the Signal Attributes tab, then change **Sample time** to -1.
- 5** Save your changes to the blocks and the model.

### **Update the Compensator Model Block.**

- 1** In the `sldemo_concurrent_execution` model, open the “Compensator” Model block: `sldemo_concurrent_execution_compensator`
- 2** Discretize the Compensator model. Replace the Integrator block, “c”, with an equivalent discrete time block (such as the Discrete Time Integrator block) or use the “Model Discretizer”.
- 3** Prevent modeling constraints by matching the sample time of the “c” block with the top model: Open the “c” block and change the **Sample time** parameters to 0.1. Matching the sample times to the top model, `sldemo_concurrent_execution`, can also be accomplished using Rate Transition blocks.
- 4** Convert blocks with continuous sample times (**Sample time** = 0) to inherited sample times (**Sample time** = -1). Open the “y1”, “y2”, and “x” blocks. For each one, click the Signal Attributes tab, then change **Sample time** to -1.

- 5 The following parameters cannot both be enabled when you build the model. Open the Configuration Parameters (**Ctrl+E**) and verify that one of the following parameters is disabled (unchecked):
  - **Minimize algebraic loop occurrences**, located on the Model Referencing pane.
  - **Single output/update function**, located on the Code Generation > Interface pane
- 6 Save your changes to the blocks and the model.

**Verify that the Models are Mapped.** Open and inspect the Task editor to see if the models are appropriately mapped:

- 1 In the Simulink model editor for `sldemo_concurrent_execution`, select **View > Model Explorer (Ctrl + H)**.
- 2 In Model Explorer, expand the top model, `sldemo_concurrent_execution`.
- 3 Under the top model, select **Configuration (Active)**, then click **Concurrent Execution** in the second column. In the third column, click the **ConfigureTasks and Map Blocks to Tasks** button.
- 4 Click **Map Blocks To Tasks**. The mapping of the models should conform to the guidelines provided by “Design Considerations”.

The `sldemo_concurrent_execution` example model is ready for you to use in “Setting Up the Model” on page 29-7 and “Deploying the Model to Your Target” on page 29-8.

## Setting Up the Model

This procedure explains how to set up a model for a multicore processor.

- 1 Apply the recommendations in “Design Considerations” to your multirate Simulink model. Or, refer to the `sldemo_concurrent_execution` example model.
- 2 Add a Target Preferences block to your model as described in “Target Preferences” on page 25-3 .

- 3** In the Target Preferences block, set **Operating System** to Linux or Windows.
- 4** If your model uses a Rate Transition block to transition between rates, then open the Rate Transition block and clear the **Ensure deterministic data transfer** check box so that the block uses the most recent data available.
- 5** Configure the model for concurrent execution:
  - a** In the Simulink model editor, select **View > Model Explorer (Ctrl + H)**.
  - b** In Model Explorer, expand the top model.
  - c** Under the top model, right click **Configuration (Active)** and select **Convert to Configuration for Concurrent Execution**. (In the `sldemo_concurrent_execution` example model, this step has already been performed.)
- 6** For each referenced model in the model hierarchy that you want to run with concurrent execution:
  - a** Copy the Target Preferences block from the top model to the referenced model.
  - b** Repeat steps 4 through 5.
- 7** Select the configuration set of the model at the top of the model hierarchy. In the second column, select the **Concurrent Execution** node. A Concurrent Execution pane appears in the third column. (In the `sldemo_concurrent_execution` example model, this step has already been performed.)
- 8** In the Concurrent Execution pane in the third column, select the **This is the top of the model hierarchy** check box, and click the **ConfigureTasks and Map Blocks to Tasks** button. (In the `sldemo_concurrent_execution` example model, this step has already been performed.)
- 9** The Concurrent Execution configuration parameters dialog box is displayed. Click **Apply**.



## Deploying the Model to Your Target

In your model, click the build button or enter **Ctrl+B**. The software performs the actions you selected for **Build action** in the Configuration Parameters dialog, on the Code Generation > IDE Link pane.

For more information on the structure of the code, please refer to “Build and Download to a Multicore Target”. As mentioned in that section, the coder product generates all target-dependent code for thread creation, thread synchronization, interrupt service routines, and signal handlers and data transfer. For each periodic task, Simulink Coder combines the output and update methods of the blocks mapped to that task and binds these methods to a target-specific thread.

---

**Note** The `idmlink_ert.tlc` or `idmlink_grt.tlc` system target files do not support Continuous times.

---

## Generated Code

For `idmlink_ert.tlc` or `idmlink_grt.tlc` system target files, the generated code from a mapped model creates a thread for each task and automatically leverages the threading APIs supported by the operating system running on the target.

- If the target platform is running Windows , the generated code will use Windows threads.
- If the target platform is running Linux or VxWorks , the generated code will use POSIX® threads (pthreads).

The following table summarizes the differences in the generated code between the target platforms.

<b>Aspect of Concurrent Execution</b>	<b>Linux</b>	<b>Windows</b>
Periodic triggering event	POSIX timer	Windows timer
Aperiodic triggering event	POSIX real-time signal	Windows event
Aperiodic trigger	For blocks mapped to an aperiodic task: thread waiting for a signal For blocks mapped to an aperiodic trigger: signal action	Thread waiting for an event
Threads	POSIX	Windows
Thread priority	Assigned based on Target Preference Block setting	Fixed
Example of overrun detection	Yes	Yes

The software checks that data transfer between concurrently executing tasks behave as described in Data Transfer Options. The software checks data transfer using the following APIs on supported targets.

<b>API</b>	<b>Linux Implementation</b>	<b>Windows Implementation</b>
Data protection API	<ul style="list-style-type: none"> <li>• pthread_mutex_init</li> <li>• pthread_mutex_destroy</li> <li>• pthread_mutex_lock</li> <li>• pthread_mutex_unlock</li> </ul>	<ul style="list-style-type: none"> <li>• CreateMutex</li> <li>• CloseHandle</li> <li>• WaitForSingleObject</li> <li>• ReleaseMutex</li> </ul>
Synchronization API	<ul style="list-style-type: none"> <li>• sem_init</li> <li>• sem_destroy</li> <li>• sem_wait</li> <li>• sem_post</li> </ul>	<ul style="list-style-type: none"> <li>• CreateSemaphore</li> <li>• CloseHandle</li> <li>• WaitForSingleObject</li> <li>• ReleaseSemaphore</li> </ul>

## Running Multirate, Multitasking Executables on the Linux Desktop

In Linux, multirate, multitasking executables require root privileges to schedule POSIX threads with real-time priority. Thus, Eclipse IDE software must have its own root privileges to run the multirate, multitasking executable with root privileges locally on your Linux development system.

If all three of the following conditions are true, start Eclipse IDE with root privileges:

- Your model produces a multirate, multitasking executable.
- Embedded Coder uses the default Configuration Parameters which automatically run the executable.

You can verify the Configuration Parameters in the **Configuration Parameters** dialog box, under **Code Generation**, select the **IDE Link** pane. Make sure that the **Build format** is Project and the **Build action** is Build\_and\_execute.

- The Eclipse plug-in is using the default settings, which run the executable on the local Linux development system. (During the `eclipseidesetup` process, you left **Site** set to local.)

If any of the following conditions are true, you do not need to start Eclipse IDE with root privileges:

- Your model produces multirate, single-tasking executables or single rate executables.
- You are performing a processor-in-the-loop (PIL) simulation.
- You are using a Windows development platform.
- You have configured Embedded Coder and Eclipse to run the executable on a remote Linux target.
- You not have configured Embedded Coder and Eclipse to run the executable.

## Starting Eclipse IDE with root privileges

- 1 Install and configure Eclipse IDE according to the instructions in “Working with Eclipse IDE”.
- 2 If an Eclipse IDE handle object exists in the MATLAB workspace, delete the object. For example, delete `IDE_Obj`.
- 3 If Eclipse IDE is running, close it.
- 4 Open a command-line session, and `cd` to the Eclipse installation folder. For example, if you installed Eclipse in `usr/bin/eclipse`, enter:

```
cd usr/bin/eclipse
```

- 5 Start Eclipse with root privileges using `sudo ./`. For example:

```
sudo ./eclipse
```
- 6 At the prompt, enter the root password.
- 7 When Eclipse starts and prompts you for the workspace, enter the same workspace you specified during the Eclipse installation and configuration process.
- 8 In IDE Link, configure the model to build and execute:
  - a In the model, select **Simulation > Model Configuration Parameters**.
  - b Under **Code Generation**, select the **IDE Link** pane.
  - c Set **Build action** to **Build and execute**.

- 9 Click **Build Model**  on the model toolstrip. This action builds, loads, and runs your code on the processor.

When the build process finishes, the multirate, multitasking executable automatically starts and runs with root privileges.

## Avoiding Lock-Up in Free-Running, Multirate, Multitasking Models

This section applies when the following conditions are true:

- The model is a multirate multitasking model
- In the Target Preferences block, on the Board pane, the **Operating system** parameter is set to Linux
- In the Target Preferences block, on the Linux pane, the **Scheduling Mode** parameter is set to free-running

Because of the rate monotonic scheduling requirement in Linux, the scheduler runs threads with a SCHED\_FIFO scheduling policy. A process scheduled with SCHED\_FIFO prevents other process from running while it is ready to run. Therefore, if the model does not contain any blocking peripherals, the entire Linux system can become unresponsive while you are running the generated code. Such lock-up can even preempt the shell window from running. To avoid this lock-up, apply one of the following solutions:

- Set **Scheduling Mode** to `real_time`.
- Include a blocking device driver, such as a UDP block, in your model that suspends running thread while data is not available.
- Raise the shell window priority above the base-rate priority so you can kill the process running with SCHED\_FIFO class.



# Working with Microsoft Windows Target

---

- “Preparing Models to Run on Windows” on page 29-2
- “Scheduler” on page 29-3

## Preparing Models to Run on Windows

To build an executable that runs on Windows, perform the following steps:

- 1 Install and configure Eclipse IDE according to the instructions in “Working with Eclipse IDE”.
- 2 Enter `desktoptargetslib` at the MATLAB prompt. This action opens the `desktoptargetslib` library.
- 3 Copy the Target Preferences block to your model.
- 4 In the **Initialize Configuration Parameters** dialog box, set **IDE/Toolchain** to Eclipse, and select the processor for which you are generating code.
- 5 Open the Target Preferences block in your model and set **Operating System** to Windows (or None).

Selecting Windows creates a **Windows** tab, which you can use to set **Scheduling Mode**.

- 6 Set the **Scheduling Mode** to one of these options:
  - If you select **real-time**, the model uses a timer to trigger the base rate at regular periods.
  - If you select **free-running**, the model does not use a timer. Instead, the model completes each process or thread before running the next one.
- 7 In IDE Link, configure the model to build and execute:
  - a In the model, select **Simulation > Model Configuration Parameters**.
  - b Under **Code Generation**, select the **IDE Link** pane.
  - c Set **Build action** to **Build and execute**.

- 8 Click **Build Model**  on the model toolbar.

After the build completes, Embedded Coder software downloads the executable to the remote system and runs it.



## Scheduler

In this section...
“Selecting the Operating System and Scheduling Mode” on page 29-3
“Base Rate” on page 29-4
“Running Target Applications on Multicore Processors” on page 29-4
“Limitations” on page 29-10

### Selecting the Operating System and Scheduling Mode

The following table refers to the **Operating System** and **Scheduling Mode** options in the Target Preferences block.

Operating System	Scheduling Mode	Behavior
Windows	free_running	The model generates multithreaded, free-running code. Each rate in the model maps to a separate thread in the generated code. Multithreaded code can potentially run faster than single-threaded code.
Windows	real_time	The model generates multithreaded, real-time code: Each rate in the Simulink model runs at the rate specified in the model. For example, a 1 s rate runs at exactly 1 s intervals.
None	Not applicable	The model generates free-running code that runs in an infinite while loop with no timing. Does not support External mode.

For more information, see “Scheduling” on page 1-4 in the *Simulink Coder User’s Guide*.

## Base Rate

The base rate in the model maps to a thread and runs as fast as possible. In Windows target, the timer resolution is 1 ms. The base rate priority selection in the OS tab allows you to set a static priority for the base rate task.

The Windows OS does not have a selection. The default base rate priority is `THREAD_PRIORITY_HIGHEST` (10) and the process running the generated code has `NORMAL_PRIORITY_CLASS`.

The process running single-tasking models has Default scheduling policy when model is single-tasking or there is a single rate in the model. Static priority of the process is 0 in this case.

## Running Target Applications on Multicore Processors

### Introduction

This section provides a variation of the process described in “Build and Download to a Multicore Target”.

This section shows you how to:

- Configure a multirate model
- Generate a multithreaded application from that model

So that the resulting application is enabled for concurrent multicore execution on a desktop target running Linux or Windows.

This process uses the `idelink_ert.tlc` or `idelink_grt.tlc` system target files, which enable you to:

- Use Eclipse IDE to manage projects for Linux and Windows targets (Support for this capability is only available on 32-bit host platforms)
- Set thread priority using a Target Preference block

## Looking at a Model

Before setting up your own model, consider the `sldemo_concurrent_execution` example model, which is referenced by “Build and Download to a Multicore Target”.

The `sldemo_concurrent_execution` model is a useful example to look at because:

- The model is partitioned using Model blocks that can potentially execute concurrently.
- You can look at the **Map Blocks To Tasks** pane in the Concurrent Execution window to see how the tasks are configured for concurrent execution.

However, you cannot run an unmodified version of the `sldemo_concurrent_execution` model on a desktop target running Linux or Windows.

To prepare the `sldemo_concurrent_execution` as an example model for the “Setting Up the Model” on page 29-7 and “Deploying the Model to Your Target” on page 29-8 topics, first perform the following modifications:

- Update the Plant Model Block
- Update the Compensator Model Block
- Verify that Models are Mapped

These procedures guide you through the processes of discretizing models and matching sample times of blocks with models.

### Update the Plant Model Block.

- 1 In the `sldemo_concurrent_execution` model, open the “Plant” Model block: `sldemo_concurrent_execution_plant`
- 2 Discretize the Plant model. Replace the Integrator blocks, “x1” and “x2”, with equivalent discrete time blocks (such as the Discrete Time Integrator block) or use the “Model Discretizer”.

- 3 Prevent modeling constraints by matching the sample time of the “x1” and “x2” blocks with the model: Open the “x1” and “x2” blocks and change the **Sample time** parameters to 0.1. Matching the sample times to the model can also be accomplished using Rate Transition blocks.
- 4 Convert blocks with continuous sample times (**Sample time** = 0) to inherited sample times (**Sample time** = -1). Open the “u1”, “u2” and “x” blocks. For each one, click the Signal Attributes tab, then change **Sample time** to -1.
- 5 Save your changes to the blocks and the model.

### **Update the Compensator Model Block.**

- 1 In the `sldemo_concurrent_execution` model, open the “Compensator” Model block: `sldemo_concurrent_execution_compensator`
- 2 Discretize the Compensator model. Replace the Integrator block, “c”, with an equivalent discrete time block (such as the Discrete Time Integrator block) or use the “Model Discretizer”.
- 3 Prevent modeling constraints by matching the sample time of the “c” block with the top model: Open the “c” block and change the **Sample time** parameters to 0.1. Matching the sample times to the top model, `sldemo_concurrent_execution`, can also be accomplished using Rate Transition blocks.
- 4 Convert blocks with continuous sample times (**Sample time** = 0) to inherited sample times (**Sample time** = -1). Open the “y1”, “y2”, and “x” blocks. For each one, click the Signal Attributes tab, then change **Sample time** to -1.
- 5 The following parameters cannot both be enabled when you build the model. Open the Configuration Parameters (**Ctrl+E**) and verify that one of the following parameters is disabled (unchecked):
  - **Minimize algebraic loop occurrences**, located on the Model Referencing pane.
  - **Single output/update function**, located on the Code Generation > Interface pane

6 Save your changes to the blocks and the model.

**Verify that the Models are Mapped.** Open and inspect the Task editor to see if the models are appropriately mapped:

- 1 In the Simulink model editor for `sldemo_concurrent_execution`, select **View > Model Explorer (Ctrl + H)**.
- 2 In Model Explorer, expand the top model, `sldemo_concurrent_execution`.
- 3 Under the top model, select **Configuration (Active)**, then click **Concurrent Execution** in the second column. In the third column, click the **ConfigureTasks and Map Blocks to Tasks** button.
- 4 Click **Map Blocks To Tasks**. The mapping of the models should conform to the guidelines provided by “Design Considerations”.

The `sldemo_concurrent_execution` example model is ready for you to use in “Setting Up the Model” on page 29-7 and “Deploying the Model to Your Target” on page 29-8.

## Setting Up the Model

This procedure explains how to set up a model for a multicore processor.

- 1 Apply the recommendations in “Design Considerations” to your multirate Simulink model. Or, refer to the `sldemo_concurrent_execution` example model.
- 2 Add a Target Preferences block to your model as described in “Target Preferences” on page 25-3 .
- 3 In the Target Preferences block, set **Operating System** to Linux or Windows.
- 4 If your model uses a Rate Transition block to transition between rates, then open the Rate Transition block and clear the **Ensure deterministic data transfer** check box so that the block uses the most recent data available.
- 5 Configure the model for concurrent execution:
  - a In the Simulink model editor, select **View > Model Explorer (Ctrl + H)**.

- b** In Model Explorer, expand the top model.
  - c** Under the top model, right click **Configuration (Active)** and select **Convert to Configuration for Concurrent Execution**. (In the `sldemo_concurrent_execution` example model, this step has already been performed.)
- 6** For each referenced model in the model hierarchy that you want to run with concurrent execution:
  - a** Copy the Target Preferences block from the top model to the referenced model.
  - b** Repeat steps 4 through 5.
- 7** Select the configuration set of the model at the top of the model hierarchy. In the second column, select the **Concurrent Execution** node. A Concurrent Execution pane appears in the third column. (In the `sldemo_concurrent_execution` example model, this step has already been performed.)
- 8** In the Concurrent Execution pane in the third column, select the **This is the top of the model hierarchy** check box, and click the **ConfigureTasks and Map Blocks to Tasks** button. (In the `sldemo_concurrent_execution` example model, this step has already been performed.)
- 9** The Concurrent Execution configuration parameters dialog box is displayed. Click **Apply**.

## Deploying the Model to Your Target

In your model, click the build button or enter **Ctrl+B**. The software performs the actions you selected for **Build action** in the Configuration Parameters dialog, on the Code Generation > IDE Link pane.

For more information on the structure of the code, please refer to “Build and Download to a Multicore Target”. As mentioned in that section, the coder product generates all target-dependent code for thread creation, thread synchronization, interrupt service routines, and signal handlers and data transfer. For each periodic task, Simulink Coder combines the output and update methods of the blocks mapped to that task and binds these methods to a target-specific thread.

---

**Note** The `idelink_ert.tlc` or `idelink_grt.tlc` system target files do not support Continuous times.

---

## Generated Code

For `idelink_ert.tlc` or `idelink_grt.tlc` system target files, the generated code from a mapped model creates a thread for each task and automatically leverages the threading APIs supported by the operating system running on the target.

- If the target platform is running Windows , the generated code will use Windows threads.
- If the target platform is running Linux or VxWorks , the generated code will use POSIX threads (pthreads).

The following table summarizes the differences in the generated code between the target platforms.

Aspect of Concurrent Execution	Linux	Windows
Periodic triggering event	POSIX timer	Windows timer
Aperiodic triggering event	POSIX real-time signal	Windows event
Aperiodic trigger	For blocks mapped to an aperiodic task: thread waiting for a signal For blocks mapped to an aperiodic trigger: signal action	Thread waiting for an event
Threads	POSIX	Windows

<b>Aspect of Concurrent Execution</b>	<b>Linux</b>	<b>Windows</b>
Thread priority	Assigned based on Target Preference Block setting	Fixed
Example of overrun detection	Yes	Yes

The software checks that data transfer between concurrently executing tasks behave as described in Data Transfer Options. The software checks data transfer using the following APIs on supported targets.

<b>API</b>	<b>Linux Implementation</b>	<b>Windows Implementation</b>
Data protection API	<ul style="list-style-type: none"> <li>• pthread_mutex_init</li> <li>• pthread_mutex_destroy</li> <li>• pthread_mutex_lock</li> <li>• pthread_mutex_unlock</li> </ul>	<ul style="list-style-type: none"> <li>• CreateMutex</li> <li>• CloseHandle</li> <li>• WaitForSingleObject</li> <li>• ReleaseMutex</li> </ul>
Synchronization API	<ul style="list-style-type: none"> <li>• sem_init</li> <li>• sem_destroy</li> <li>• sem_wait</li> <li>• sem_post</li> </ul>	<ul style="list-style-type: none"> <li>• CreateSemaphore</li> <li>• CloseHandle</li> <li>• WaitForSingleObject</li> <li>• ReleaseSemaphore</li> </ul>

## Limitations

### **Profiling is not available for Intel x86/Pentium and AMD K5/K6/Athlon processors running Windows or Linux Operating Systems**

If you use Embedded Coder with Eclipse to build and run applications on processors running Windows or Linux: The stack profiling and real-time execution profiling is only available for ARM® processors running Linux.



Profiling is not available for Intel x86/Pentium and AMD K5/K6/Athlon processors running Windows or Linux.



# Examples

---

Use this list to find examples in the documentation.

## **Models**

“Single-Tasking and Multitasking Model Execution” on page 1-27

“Spawn a Wind River Systems VxWorks Task” on page 1-46

“Block Execution Order” on page 1-120

“Generate Code for Signal Objects from Command Line” on page 7-67

“Optimization Tools and Techniques” on page 16-7

“Inline Invariant Signals” on page 18-18

“Configure Loop Unrolling Threshold” on page 19-4

## **Timing Services**

“Elapsed Timer Code Generation Example” on page 1-85

## **Model Reference**

“Generate Code for Referenced Models” on page 3-4

“Code Reuse and Model Blocks with Root Inport or Outport Blocks” on page 3-33

## **Data Management**

“Nontunable Parameter Storage” on page 7-11

“Tunable Expressions in Masked Subsystems” on page 15-129

“Signals with Auto Storage Class” on page 7-55

“Symbolic Naming Conventions for Signals” on page 7-62

“Tunable Expressions in Masked Subsystems” on page 15-129

## **Custom Code**

“Embed Custom Code Directly Into MdlStart Function” on page 14-40



## S-Functions

“TLC S-Function Wrapper” on page 14-59

“Write Fully Inlined S-Functions” on page 14-64

“Multiport S-Function” on page 14-65

“S-Function RTWdata” on page 14-67

“Direct-Index Lookup Table Example” on page 14-69

## **Optimizations**

“Expression Folding for Blocks with Multiple Outputs” on page 14-103

“Optimizing Generated Code” on page 18-2

“Expression Folding Example” on page 18-12

## **External Mode**

“Set Up an External Mode Communication Channel” on page 15-51

## **Verification**

“Log Data for Analysis” on page 15-106

## Interfaces

“Generate Example C API Files” on page 15-146

“Use the C API in an Application” on page 15-160

## **Advanced Code Generation**

“Example Build Process Customization Using `sl_customization.m`” on page 22-31

## **Code Generation Using Makefiles**

“Creating a New XMakefile Configuration” on page 25-25





## A

- absolute time computation 1-79
- addLibs field 14-132
- algorithm models
  - integrating for real-time rapid prototyping 13-2
- APIs
  - timer services 1-81
- ASAP2 files
  - customizing 23-2
  - data attributes required for 15-175
  - generating 15-182
  - structure of 15-187
  - targets supporting 15-175
- asynchronous tasks
  - timers for 1-80
- atomic subsystem 2-2
- automatic S-function generation 14-23
  - See also* S-function target

## B

- block states
  - Simulink data objects and 7-90
  - State Properties dialog box and 7-85
  - storage and interfacing 7-83
  - storage classes for 7-84
  - symbolic names for 7-87
- block-based code integration
  - with S-functions 14-120
- blocks
  - Custom Code 14-36
  - depending on absolute time 1-89
  - Model Header 14-37
  - Model Source 14-37
  - Rate Transition 1-14
- blocks, Simulink
  - support for 1-94
- boards, selecting 25-17
- Browse button

- on Code Generation pane 9-35
- buffer reuse option 20-5
- build folder
  - contents of 10-29
  - naming convention 10-28
  - seeing files 15-24 15-44
  - sldemo\_f14 example 15-25
- build folder optional contents
  - C API files 10-30
  - HTML report files 10-30
  - model.rtw* 10-29
  - object files 10-29
  - project files 10-30
  - subsystem code modules 10-30
  - TLC profiler files 10-30
- build format 25-10
- build process
  - COM automation of 24-131
  - controlling 22-7
  - files and folders created 10-24
  - interfacing to development tools
    - integrated development environments 24-124
    - make utilities 24-124
  - messages in MATLAB Command Window 15-23 15-43
  - passing information in 24-32
  - phases of 24-30
  - steps in 15-38
- build specification 14-131

## C

- C API
  - files used in 15-141
  - for S-functions 1-82
  - generating files 15-138
  - introduction 15-137
  - mapping to real-time model 15-158
  - using for your application 15-160

- C language
  - selecting 9-71
- C++ encapsulation interface control, custom
  - target support for 24-121
- C++ language
  - selecting 9-71
- checksums
  - and S-Function target 12-45
  - for models 12-45
  - subsystem 12-45
- code
  - integrating existing 14-2
    - build support for 14-120
- code files
  - porting 15-33
  - relocating 15-33
- code format
  - choosing 9-16
  - embedded 9-24
  - real-time 9-20
  - real-time malloc 9-22
  - S-function 9-23
- code generation
  - TLC variables for 24-41
- code generation example 18-2
- code generation options
  - Application lifespan (days) 16-9
  - Boolean logic signals 20-3
  - buffer reuse 20-5
    - See also* signal storage reuse 20-5
  - Classic call interface 9-29
  - Compiler optimization level 16-6
  - create code generation report 11-5
  - Custom compiler optimization flags 16-6
  - expression folding 18-11
  - Generate makefile option 15-13
  - inline invariant signals 18-18
  - inline parameters 19-2
  - local block outputs 18-17
    - See also* signal storage reuse 18-17
  - loop rolling threshold 19-4
  - MAT-file variable name modifier 9-59
  - retain .rtw file 9-80
  - show eliminated blocks 9-72
  - signal storage reuse 20-4
    - See also* local block outputs 20-4
  - Solver pane 1-90
  - TLC options 15-12
  - Use memcpy for vector assignment 19-6
  - verbose builds 9-80
- Code Generation pane 9-2
  - Language option 9-71
  - opening 9-2
  - target configuration options
    - Browse button 9-35
    - Generate makefile 15-13
    - make command field 15-13
    - system target file field 9-35
    - template makefile field 15-13
    - TLC options 15-12
- Code replacement library option
  - relationship to TGT\_FCN\_LIB variable 22-3
- code reuse
  - diagnostics for 2-32
- code verification example 21-1
- code with buffer optimization 18-10
  - efficiency 18-10
- code with expression folding 18-13
- code without buffer optimization 18-6
- code, generated
  - testing in system environment 13-5
- combining models
  - by using grt\_malloc target 4-2
  - in Embedded Coder target 4-2
- comments options 15-23
- communication
  - External mode 15-51
- compilation 22-2
  - customizing 22-3
- compiler

- configuring 15-2
- Compiler optimization level control, custom
  - target support for 24-115
- compiler options
  - specifying 22-3
- compilers
  - list of supported 15-2
  - MEX 15-2
  - optimization settings 15-10
  - version mismatches for 15-9
- component models
  - integrating for real-time rapid prototyping 13-2
- configuration parameters
  - TargetLibSuffix
    - controlling suffix applied to library names with 22-10
  - TargetPreCompLibLocation
    - controlling location of precompiled libraries with 22-8
- Configuration Parameters dialog box
  - Code Generation pane 9-2
  - Solver options pane 1-90
- controller models
  - integrating for real-time rapid prototyping 13-2
- counters
  - in triggered subsystems 1-81
  - time 1-80
- Create code generation report 11-5
- cross-development
  - relocating files for 15-33
- custcode command 14-36
- custom code
  - build support for 14-120
  - integrating with C MEX S-functions 14-28
  - integrating with generated code 14-2
- Custom Code blocks 14-36
  - example 14-40
  - in subsystems 14-43

- Custom Code library
  - overview 14-36
- custom target
  - components of 24-12
    - application 24-13
    - code 24-13
    - control files 24-15
    - device drivers 24-15
    - interrupt service routines 24-14
    - main program 24-14
    - run-time interface 24-13
  - purpose of 24-2
- custom target configuration
  - tutorial 24-61

## D

- data logging 15-106
  - from generated code 21-7
  - tutorial 15-106
  - via Scope blocks
    - example 21-3
- Data Store Memory blocks
  - Simulink data objects and 7-96
- data structures in generated code
  - block I/O 8-28
  - block parameters 8-28
  - block states 8-28
  - external inputs 8-28
  - external outputs 8-28
- debug options 15-21
- declaration code 14-39
- development environments
  - supporting multiple 24-60
- dialog boxes
  - Block Parameters 15-53
  - External Mode Control Panel 15-59
  - External Signal and Triggering 15-60
- direct-index lookup table
  - algorithm 14-67

- example 14-69
- discrete states
  - initializing 7-74
- documentation 11-16
- dt\_info.h 10-13

## E

- Eclipse™ IDE for C/C++ Developers 27-5
- elapsed time computation 1-79
- elapsed time counters 1-80
  - in triggered subsystems 1-81
- elapsed timer
  - example 1-85
- entry points, model 8-2
- examples
  - building generic real-time program 15-14
  - code generation 18-2
  - code verification 21-1
  - data logging 15-106
  - direct-index lookup table 14-69
  - External mode 15-51
  - model referencing 3-4
  - multiport S-function 14-65
- executable
  - running 15-24 15-43
- execution code 14-39
- exit code 14-39
- Expression folding 18-11
  - in S-Functions 14-91
- ext\_work.h 10-13
- External mode 15-50
  - architecture 15-88
  - baud rates 15-74
  - blocks compatible with 15-83
  - building executable 15-54
  - client-server architecture 23-14
  - command line options for target
    - program 15-97
  - communication channel creation 23-14

- communications overview 23-17
- configuration parameter options 15-64
- control panel 15-59
- control panel options 15-70
- data archiving options 15-79
- design of 23-14
- download mechanism 15-87
- example 15-51
- ext\_comm MEX-file
  - optional arguments to (serial) 15-94
  - optional arguments to (TCP/IP) 15-92
  - rebuilding 23-25
- host and target systems in 15-50
- menu and toolbar items and keyboard shortcuts 15-66
- model setup 15-52
- parameter downloading options 15-82
- parameter tuning 15-62
- running executable 15-58
- Signal Viewing Subsystems in 15-84
- signals and triggering options 15-75
- target communications options 15-73
- TCP implementation 15-90
- transport layer 23-17

- External mode API
  - host source files 23-19
  - implementing transport layer 23-23
  - target source files 23-21
- External Target Interface dialog box
  - MEX-file arguments 15-74

## F

- files
  - for inlined S-functions 14-29
  - generated. *See* generated files
- firstTime argument control, custom target support for 24-117
- fixed-step solver 15-16
- fixedpoint.h 10-13

float.h 10-11  
 folder  
   precompiled library 14-130  
 folders  
   build 15-15  
   used in build process 15-2  
   working 15-15  
 From File block  
   specifying signal data file for 12-24  
 Function prototype control, custom target  
   support for 24-119  
 functions  
   rtw\_precompile\_libs 14-129  
   ssSetChecksumVal 12-45

## G

general code appearance options  
   Maximum identifier length 9-73  
   Reserved names 9-73  
 generate optimized code 25-9  
 generated code  
   compiling and linking 22-2  
   include path specification 10-21  
   profiling 15-45  
   testing in system environment 13-5  
 generated files 10-24  
   contents of 10-4  
   dependencies among 10-4  
   model (UNIX executable) 10-26  
   model file 10-24  
   model.bat 10-27  
   model.c 10-24  
   model\_capi.c 10-28  
   model\_capi.h 10-28  
   model\_data.c 10-26  
   model\_dt.h 10-27  
   model.exe (PC executable) 10-26  
   model.h 10-25  
   model.mk 10-26

model\_private.h 10-25  
 model.rtw 10-24  
 model\_targ\_data\_map.m 10-27  
 model\_target\_rtw 10-28  
 model\_types.h 10-25  
 modelsources.txt 10-27  
 rt\_nonfinite.c 10-27  
 rt\_nonfinite.h 10-27  
 rt\_sfcn\_helper.c, 10-28  
 rt\_sfcn\_helper.h 10-28  
 rtmodel.h 10-26  
 rtw\_proj.tmw 10-27  
 rtwtypes.h 10-26  
 subsystem.c 10-27  
 subsystem.h 10-28

generated S-functions  
   tunable parameters in 12-42  
 generic real-time (GRT) target  
   example 15-14  
 GNU® Tool Chain on Linux® 27-6  
 GNU® Tool Chain on Windows® 27-7

## H

hand-written code  
   build support for 14-120  
   integrating with generated code 14-2  
 hardware-in-the-loop (HIL) testing  
   verifying generated code in system  
     environment with 13-5  
 header files  
   dependencies of  
     model.h 10-9  
     rtwtypes.h 10-6  
 hook files  
   STF\_make\_rtw\_hook 24-23  
     customizing build process with 22-21  
   STF\_wrap\_make\_cmd\_hook 24-23  
 hook interface  
   for profiling generated code 15-45

host  
in External mode 15-50

**I**

include paths  
specifying 10-21  
initial values  
tunable 7-82  
initialization  
of signals and discrete states 7-74  
inlined S-functions 14-64  
with mdlRTW routine 14-66  
Inport block  
latch options  
generated code for option 1-120  
specifying signal data file for 12-27  
integration, code  
build support for 14-120  
interrupt service routine  
under VxWorks 1-6  
interrupt service routine (ISR) 24-14  
interrupt service routines 1-37  
interrupts  
handling 1-37  
intOnlyBuild field 14-132  
issues, using PIL 26-12

**L**

Language option  
description of 9-71  
Latch input by copying inside signal option  
generated code for 1-120  
Latch input by delaying outside signal  
generated code for 1-120  
latches  
generated code for 1-120  
legacy code  
build support for 14-120

integrating with C MEX S-functions 14-28  
integrating with generated code 14-2

**Legacy Code Tool**

deploying S-functions generated with 14-32  
generating code with 14-28

**legacy\_code** function

addressing file dependencies for code  
generation 14-31

**LibAddToCommonIncludes** function

using for S-function build support 14-123

**LibAddToModelSources** function

using for S-function build support 14-123

**libraries**

controlling suffix applied to names of 22-10  
model reference

controlling the location of 22-9

**precompiled**

controlling the location of 22-8

**S-function**

precompiling 14-129

suffixes for 14-131

local block outputs option 18-17

**M**

make command 24-82

make\_rtw 15-13

makefile 15-39

customizations 22-7

options for 14-132

makefile commands

USE\_MDLREF\_LIBPATHS

controlling location of model reference  
libraries with 22-9

makeInfo.precompile rtwmakecfg field 14-130

makeOpts field 14-132

MAT-files

creating 15-111

loading 21-7

math.h 10-11

- MATLAB application data 24-33
- MATLAB blocks
  - and Stateflow optimizations 19-5
- MATLAB Report Generator
  - opening 11-18
  - setting report output options for 11-20
  - specifying models and subsystems with 11-21
- mdlRTW routine
  - writing inlined S-functions 14-65
- MEX S-function wrapper
  - definition 14-55
- model* (UNIX executable) 10-26
- model compiling process 10-31
- Model Configuration Parameters dialog box
  - using 7-18
- model entry points 8-2
- model execution
  - in real time 1-12
  - in Simulink 1-12
  - Simulink versus real-time 1-11
- Model Explorer
  - viewing code in 3-13
- model file 10-24
- Model Header block 14-37
- Model Parameter Configuration dialog box
  - tunable parameters and 7-10
  - using 15-125
- model reference
  - compatibility of top and referenced models 3-19
  - inherited sample time and 3-29
  - parameter interfacing 3-26
  - project folder structure and 3-16
  - signal interfacing 3-25
  - subsystem code reuse and 3-32
- model reference libraries
  - controlling location of 22-9
- model referencing
  - converting to 3-7
  - definition of 3-4
    - example 3-4
    - generating code 3-11
- Model referencing, custom target support for 24-101
- Model Source block 14-37
- model.bat* 10-27
- model.c* 10-24
- model\_capi.c* 10-28
- model\_capi.h* 10-28
- model\_data.c* 10-26
- model\_dt.h* 10-27
- model.exe* (PC executable) 10-26
- model.h* 10-25
- model.mk* 10-26
- model\_private.h* 10-25
- model.rtw* 10-24
- model\_targ\_data\_map.m* 10-27
- model\_target\_rtw* 10-28
- model\_types.h* 10-25
- models
  - checksums for 12-45
  - code files for
    - porting 15-33
    - relocating 15-33
  - integrating for real-time rapid prototyping 13-2
  - reference
    - building in parallel 24-102
- modelsources.txt* 10-27
- multiple models
  - combining 4-1
- multiport S-function example 14-65
- multitasking
  - automatic rate transition 1-20
  - building program for 1-10
  - enabling 1-10
  - example model 1-27
  - execution 1-31
  - inserted rate transition block HTML report 1-21

- model execution 1-6
- operation 1-13
- task identifiers in 1-7
- task priorities 1-7
- versus single-tasking 1-5

## N

- noninlined S-functions 14-52
- nonvirtual subsystems
  - atomic 2-2
  - categories of 2-2
  - conditionally executed 2-2
  - modularity of code generated from 2-3

## O

- operating system
  - tasking primitives 8-12
- optimization pane
  - Stateflow and MATLAB options 19-5
- optimization, processor specific 25-9
- optimizations
  - expression folding 18-13
  - signal storage reuse 18-9

## P

- parallel builds 24-102
- parameters
  - interfacing 7-10
  - setting 15-16
  - storage declarations 7-10
  - TargetPreCompLibLocation 14-130
  - tunable 7-10
  - tuning 7-10
- performance
  - of generated code 15-45
- periodic tasks
  - timers for 1-80
- persistent signals

- initialization of 7-80
- PIL issues 26-12
- pilot G Force plot 15-110
- precompiled libraries
  - controlling location of 22-8
- priority
  - of sample rates 1-8
- processor configuration options
  - build action 25-10
  - overflow action 25-11
- processor specific optimization 25-9
- ProfileGenCode variable 15-47
- ProfilerTLC variable 15-47
- program architecture
  - program execution 8-18
  - program timing 8-16
- project
  - documenting 11-16
- project folder 10-29
  - working with 3-14
- project generation
  - selecting the board 25-17
- prototyping, rapid
  - integrating component models for 13-2
- pseudomultitasking 1-8

## R

- rapid prototyping
  - integrating component models for 13-2
- rapid simulation target 12-2
  - batch simulations (Monte Carlo) 12-19
  - command line options 12-21
  - limitations 12-33
  - output filename specification 12-32
  - parameter structure access 12-24
  - signal data file specification for From File
    - block 12-24
  - signal data file specification for Inport
    - block 12-27



- rate transition block
    - and continuous sample time 1-22
  - Rate Transition block 1-14
    - auto-insertion of 1-20
    - HTML report of automatically inserted 1-21
  - rate transitions
    - faster to slower 1-22
    - slower to faster 1-24
  - real time
    - executing models in 1-12
  - real-time malloc target 9-22
    - combining models with 4-2
  - real-time model data structure 9-24
  - recommended target features 24-5
  - reference models
    - building in parallel 24-102
  - referenced models
    - code generation incompatibilities 3-19
  - registration files
    - multiple
      - for code generation 14-31
  - report format 11-20
  - Report Generator
    - customizing reports with 11-22
    - opening 11-18
    - setting report format for 11-20
    - setting report location for 11-20
    - setting report name for 11-20
    - setting report output options for 11-20
    - specifying models and subsystems with 11-21
  - report location 11-20
  - report name 11-20
  - report output options 11-20
  - reports
    - generating code generation 11-16
  - reset value
    - initial value as 7-82
  - root models
    - Custom Code blocks in 14-37
  - rsim
    - See* rapid simulation target 12-2
  - rt\_logging.h 10-13
  - rt\_nonfinite.c 10-27
  - rt\_nonfinite.h 10-27
  - rt\_sfcn\_helper.c 10-28
  - rt\_sfcn\_helper.h 10-28
  - rtm macros 9-24
  - rtModel 9-24
  - rtmodel.h 10-26
  - rtw\_continuous.h 10-14
  - rtw\_extmode.h 10-14
  - rtw\_local\_blk\_outs 7-56
  - rtw\_matlogging.h 10-14
  - rtw\_precompile\_libs function 14-129
  - rtw\_proj.tmw 10-27
  - rtw\_solver.h 10-14
  - RTWdata structure
    - inlining an S-function 14-67
  - rtwgensettings structure 24-44
  - rtwlib command 14-36
  - rtwmakecfg field
    - TargetPreComplibLocation 14-130
  - rtwmakecfg.m
    - creating S-functions 14-125
    - generating for C MEX S-functions 14-31
    - using for S-functions 14-124
  - rtwmakecfgDirs field 14-131
  - rtwMakecftDirs field 14-131
  - rtwoptions structure
    - callbacks in 24-52
    - example of 24-48
    - fields in 24-50
    - overview of 24-47
  - rtwtypes.h 10-26
  - run-time interface modules 18-5
- S**
- S-Function blocks
    - masked

- configured to call existing external code 14-28
- S-function libraries
  - precompiling 14-129
- S-function target 9-23
  - applications of 12-34
  - automatic S-function generation 14-23
  - generating reusable components with 12-37
  - tunable parameters in 12-42
- S-Function target
  - checksums and 12-45
- S-functions
  - build support for 14-120
  - creating `rtwmakecfg.m` for 14-125
  - deploying generated 14-32
  - fully inlined with `mdlRTW` routine 14-65
  - generating automatically 14-23
  - implicit build support for 14-121
  - inlined 14-64
    - generated with Legacy Code Tool 14-28
    - generating files for 14-29
  - modifying TMF for 14-127
  - noninlined 14-52
  - setting `SFunctionModules` parameter for 14-122
  - that work with Simulink Coder 14-46
  - types of 14-48
  - using `rtwmakecfg.m` for 14-124
  - using TLC library functions for 14-123
  - wrapper 14-54
- sample rate transitions 1-13
  - faster to slower
    - in real-time 1-23
    - in Simulink 1-22
  - slower to faster
    - in real-time 1-25
    - in Simulink 1-24
- sample time constraints
  - setting for multitasking 1-6
- sample time properties
  - setting for multitasking 1-6
- selecting boards 25-17
- set stack size 25-12
- `SFunctionModules` parameter
  - setting 14-122
- signal data
  - specifying for From File block 12-24
  - specifying for Inport block 12-27
- signal initialization
  - in generated code 7-80
- signal objects
  - initializing 7-74
- signal properties 7-36
  - setting by using Signal Properties dialog box 7-36
- signal storage reuse option 20-4
- Signal Viewing Subsystems 15-84
- signals
  - initializing 7-74
- `simstruc.h` 10-15
- `simstruc_types.h` 10-15
- Simulink
  - and Simulink Coder
    - block execution order 1-120
    - interactions to consider 1-117
    - sample time propagation 1-119
    - using parameter objects 7-38
    - using signal objects 7-65
- Simulink Coder
  - parameters
    - interfacing 7-10
    - storage 7-10
    - tuning 7-10
  - third-party compilers
    - support 15-2
- Simulink data objects
  - parameter objects 7-38
  - signal objects 7-65
- Simulink Report Generator
  - customizing reports with 11-22

- opening 11-18
  - setting report format for 11-20
  - setting report location for 11-20
  - setting report name for 11-20
  - setting report output options for 11-20
  - specifying models and subsystems with 11-21
  - single-tasking 1-10
    - building program for 1-10
    - enabling 1-11
    - example model 1-27
    - execution 1-28
    - operation 1-13
  - sldemo\_f14 GRT code generation example 15-14
  - slprj folder 10-29
  - ssSetChecksumVal function 12-45
  - stack size, set stack size 25-12
  - states, discrete
    - initializing 7-74
  - <stddef.h> 10-11
  - <stdio.h> 10-11
  - <stdlib.h> 10-12
  - STF\_make\_rtw\_hook function
    - arguments to 22-22
  - storage classes
    - required for signal initialization 7-74
  - <string.h> 10-12
  - subsystem.c 10-27
  - subsystem.h 10-28
  - subsystems
    - checksums for 12-45
    - converting to referenced models 3-7
    - custom code blocks in 14-43
    - treating as atomic units 3-6
  - suffixes
    - precompiled library 14-131
  - Sun™ Java™ Runtime Environment 27-3
  - symbols options 15-22
  - <sysran\_types.h> 10-15
  - System Derivatives function block 14-39
  - System Disable function block 14-39
  - System Enable function block 14-39
  - system environment
    - testing generated code in 13-5
  - System Initialize function block 14-39
  - System Outputs function block 14-39
  - System Start function block 14-39
  - system target file 10-32
  - system target file (STF)
    - customization techniques 24-54
    - defining target options in 24-43
    - header comments section 24-40
    - location of 24-37
    - naming conventions for 24-37
    - overview of 24-36
    - RTW\_OPTIONS section 24-43
    - rtwgensettings structure 24-44
    - structure of 24-37
    - target options inheritance mechanism 24-53
    - TLC entry point in 24-42
    - TLC variables section 24-41
  - System Target File Browser 9-34
  - system target file creation
    - tutorial 24-61
  - system target files
    - selecting programmatically 9-37
  - System Terminate function block 14-39
  - System Update function block 14-39
- ## T
- target
    - how to specify 15-18
    - rapid simulation
      - See rapid simulation target 12-2
    - real-time malloc
      - See real-time malloc target 9-22
  - target file
    - system 10-32
  - target files
    - main.c 24-23

- naming conventions 24-11
- system target file (STF) 24-21
- target settings file 24-22
- template makefile (TMF) 24-22
- target folders
  - blocks Folder 24-18
  - central folder 24-18
  - development tool support files in 24-20
  - for common source files 24-20
  - for target preferences classes 24-20
  - naming conventions 24-11
  - target root 24-12
  - target root folder 24-17
- Target Language Compiler
  - code generation variables 24-41
  - function library 10-31
  - generation of code by 10-31
  - TLC scripts 10-31
- target options inheritance 24-53
  - mechanism for 24-53
- target root folder 24-12
- target types
  - baseline 24-3
  - cosimulation 24-4
  - turnkey 24-4
- TargetLibSuffix parameter
  - controlling suffix applied to library names with 22-10
- TargetPreCompLibLocation parameter 14-130
  - controlling location of precompiled libraries with 22-8
- targets
  - available configurations 9-12
  - selecting programmatically 9-37
- task
  - spawning 1-46
- task identifier (tid) 1-7
- template makefile
  - compiler-specific 9-38
  - structure of 24-75
  - tokens 24-76
- template makefile options
  - LCC 9-43
  - UNIX 9-39
  - Visual C++ 9-40
  - Watcom 9-42
- template makefile variables
  - TGT\_FCN\_LIB 22-3
- TGT\_FCN\_LIB template makefile variable 22-3
- time counters 1-80
  - in triggered subsystems 1-81
- timer, elapsed
  - example 1-85
- timers 1-79
  - allocation of 1-80
  - APIs for accessing 1-81
  - integer 1-81
- timing services 1-79
- TLC API
  - for code generation 1-84
- TLC block file
  - generating for C MEX S-functions 14-29
- TLC hook function interface
  - for profiling generated code 15-45
- TLC library functions
  - using for inlined S-functions 14-123
- TMFs
  - modifying for S-functions 14-127
- tokens 24-76
- tunable expressions 7-10 7-22 15-129
  - in masked subsystems 7-22 15-129
  - operators, restrictions on 7-24 15-131
- tunable parameters
  - in signal initial values 7-82
- tuning parameters 15-62
- tutorials
  - creating custom target configuration 24-61

**U**

USE\_MDLREF\_LIBPATHS command  
    controlling location of model reference  
    libraries with 22-9  
user code  
    build support for 14-120  
    integrating with generated code 14-2

**V**

variable-step solver 15-16

## Variables

    ProfileGenCode 15-47  
    ProfilerTLC 15-47  
VxWorks task  
    spawning 1-46

**W**

working folder 10-28  
wrapper S-functions 14-54